

GaAs IC 25 dB Voltage Variable Attenuator 2.7–4.0 GHz



AV141-321

Features

- Power Control for 3.5 GHz Fixed Wireless Applications
- Minimum 25 dB Attenuation
- Positive 0.2–1.2 V Control Voltage
- QFN-12 3 x 3 mm Package
- Low Cost
- No External Components Needed

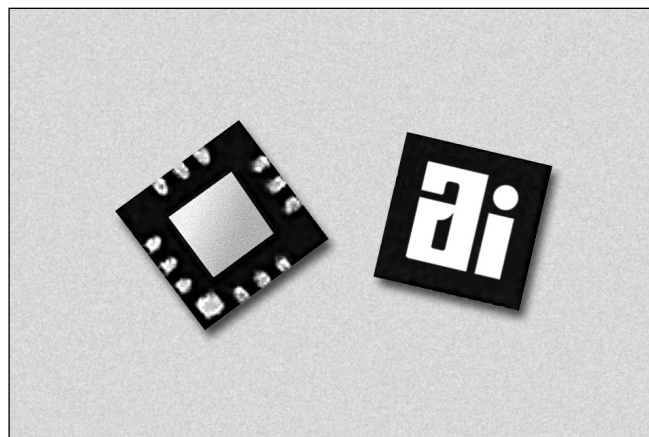

Description

The AV141-321 is a GaAs IC PHEMT voltage variable attenuator that has been designed for WLAN applications. Operating from 2.7–4.0 GHz, the AV141-321 is ideal for low cost applications such as 3.5 GHz fixed wireless LAN power control applications.

Absolute Maximum Ratings

Characteristic	Value
RF Input Power	1 W Max. > 500 MHz
Control Voltage	-0.2 V, +6 V
Operating Temperature	-40°C to +85°C
Storage Temperature	-65°C to +150°C

1. All measurements made in a 50 Ω system, unless otherwise specified.
2. For worst case state.

Electrical Specifications at 25°C

Parameter	Frequency	Min.	Typ.	Max.	Unit
Insertion Loss ($V_C = 1.2$ V)	2.7–4.0 GHz		0.7	1.0	dB
Maximum Attenuation ($V_C = 0.2$ V)	2.7–4.0 GHz	25	30		dB
VSWR — All Ports	2.7–4.0 GHz		1.5	1.8	

Operating Characteristics at 25°C (0, +1.2 V)

Parameter	Condition	Frequency	Min.	Typ.	Max.	Unit
Switching Characteristics	Rise, Fall (10/90% or 90/10% RF)		80	50		ns
	On, Off (50% CTL to 90/10% RF)			150		ns
	Video Feedthru			25		mV
Maximum Input Power for < 1 dB Attenuation Variation		2.7–4.0 GHz		13		dBm
Input 3rd Order Intercept Point (IIP3)		2.7–4.0 GHz		20		dBm
Control Voltage			0.2		1.2	V

1. All measurements made in a 50 Ω system, unless otherwise specified.
2. For worst case state.

Typical Performance Data at 25°C

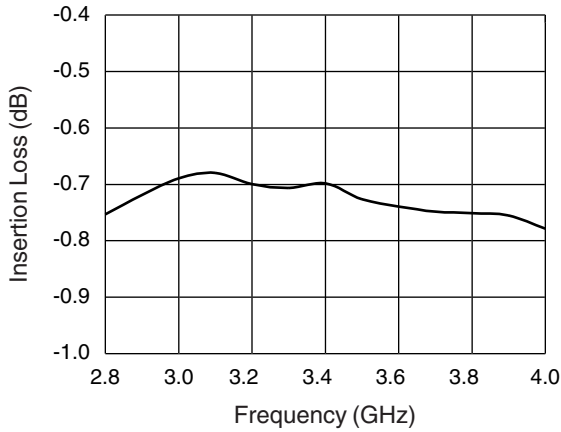

Insertion Loss vs. Frequency

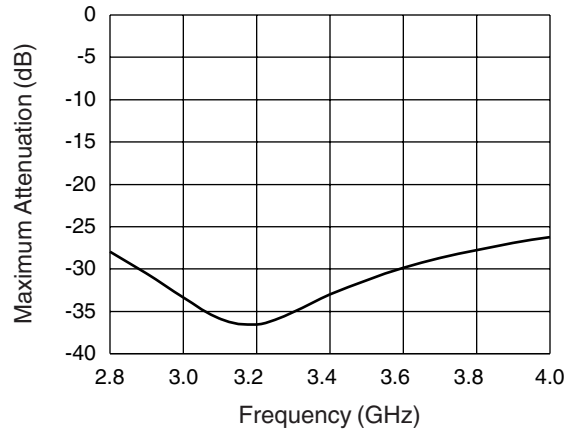

Maximum Attenuation vs. Frequency

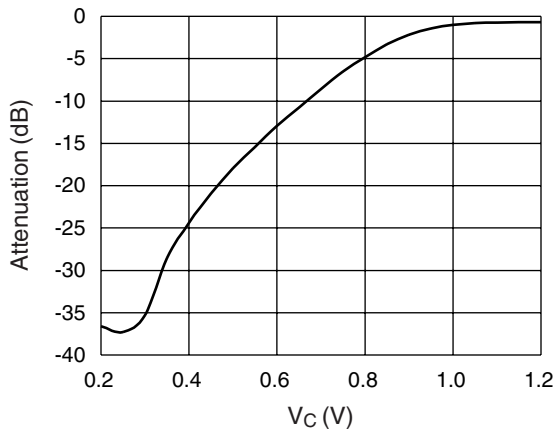

Attenuation vs. Control Voltage

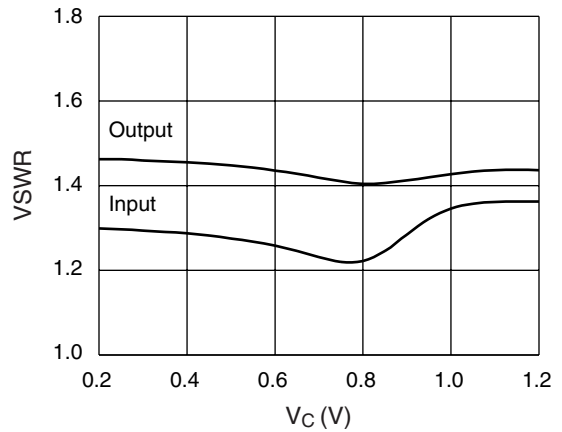

VSWR vs. Control Voltage

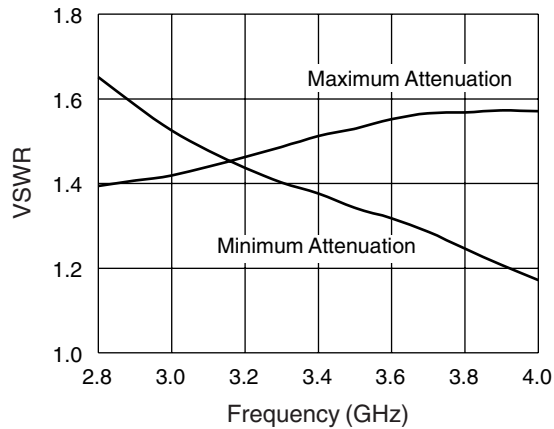

Output VSWR vs. Frequency

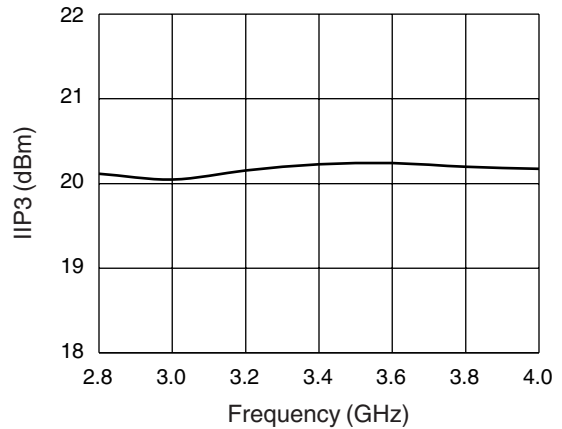

Input IP3 vs. Frequency

Evaluation Board Layout

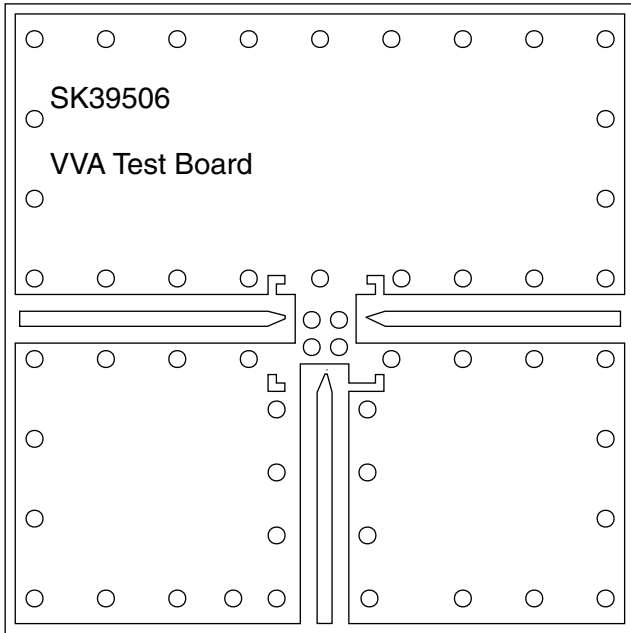

QFN-12

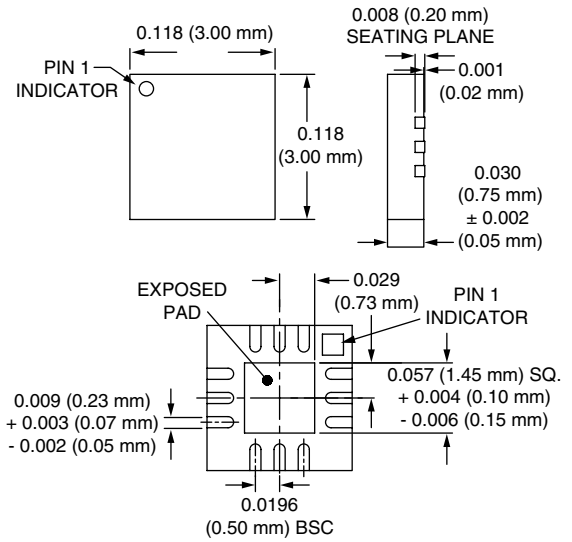

Pin Out

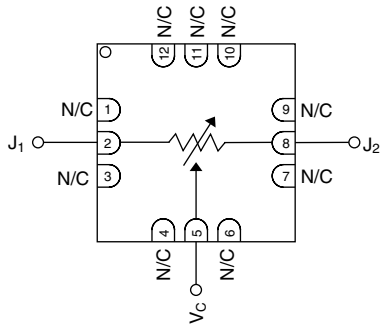

Ground is connected to paddle on bottom.

Typical S-Parameters (Control Voltage 0/+1.2 V)

Insertion Loss State # GHZ S MA R 50									High Attenuation State # GHZ S MA R 50							
Freq. (GHz)	S ₁₁	S _{11a}	S ₂₁	S _{21a}	S ₁₂	S _{12a}	S ₂₂	S _{22a}	S ₁₁	S _{11a}	S ₂₁	S _{21a}	S ₁₂	S _{12a}	S ₂₂	S _{22a}
2.5	0.330	66.05	0.887	-135.38	0.913	-135.67	0.312	45.02	0.160	5.13	0.074	126.57	0.074	126.20	0.161	-18.79
3.0	0.242	18.19	0.914	-175.58	0.946	-175.25	0.210	-22.04	0.129	-40.89	0.021	46.26	0.021	46.12	0.172	-71.10
3.5	0.165	-33.76	0.913	144.77	0.951	144.79	0.145	-94.37	0.152	-97.28	0.026	-107.80	0.026	-107.54	0.209	-118.44
4.0	0.070	-68.30	0.916	103.60	0.959	103.52	0.080	-152.16	0.134	-151.61	0.046	-178.59	0.047	-179.41	0.224	-161.45

Measured S-Parameters include the evaluation board.