

ZXRD1000 SERIES

ABSOLUTE MAXIMUM RATINGS

Input without bootstrap (P suffix)	20V	R_{SENSE+} , R_{SENSE-}	V_{IN}
Input with bootstrap(N suffix)	10V	Power dissipation	610mW (Note 4)
Bootstrap voltage	20V	Operating temperature	-40 to +85°C
Shutdown pin	V_{IN}	Storage temperature	-55 to +125°C
LB _{SET} pin	V_{IN}		

ELECTRICAL CHARACTERISTICS

TEST CONDITIONS (Unless otherwise stated) $T_{amb}=25^{\circ}C$

Symbol	Parameter	Conditions	Min	Typ	Max	Unit
$V_{IN(min)}$	Min. Operating Voltage	No Output Device	4.5			V
V_{FB} (Note 1)	Feedback Voltage	$V_{IN}=5V, I_{FB}=1mA$	1.215	1.24	1.265	V
		$4.5 < V_{IN} < 18V$	1.213	1.24	1.267	V
		$50\mu A < I_{FB} < 1mA, V_{IN}=5V$	1.215	1.24	1.265	V
T_{DRIVE}	Gate Output Drive Capability	$C_G=2200pF$ (Note 2) $C_G=1000pF$ $V_{IN}=4.5V$ to maximim supply (Note 3)		60		ns
				35		ns
I_{CC}	Supply Current	$V_{IN}=5V$		16	20	mA
	Shutdown Current	$V_{SHDN} = 0V; V_{IN}=5V$		15	50	μA
f_{osc} (Note 5)	Operating frequency range	$C_3=1300pF$ $C_3=330pF$	50		300	kHz
	Frequency with timing capacitor			50	200	
$f_{osc(tol)}$	Oscillator Tol.				± 25	%
DC _{MAX}	Max Duty Cycle	N Channel	15		94	%
		P Channel	0		100	%
V_{RSENSE}	R_{SENSE} voltage differential	-40 to +85°C		50		mV
$V_{CMRSENSE}$	Common mode range of V_{RSENSE}	-40 to +85°C	2		V_{IN}	V
LB _{SET}	Low Battery Flag set voltage		1.5		V_{IN}	V
LB _{OUT}	Low Battery Flag output	Active Low		0.2	0.4	V
LB _{HYST}	Low Battery Flag Hysteresis		10	20	50	mV
LB _{SINK}	Low Battery Flag Sink Current	-40 to +85°C			2	mA
V_{SHDN}	Shutdown Threshold Voltage	Low(off)			0.25	V
		High(on)	1.5			V
I_{SHDN}	Shutdown Pin Source Current			10		μA

Note 1. V_{FB} has a different function between fixed and adjustable controller options.

Note 2. 2200pF is the maximum recommended gate capacitance.

Note 3. Maximum supply for P phase controllers is 18V, maximum supply for N phase controllers is 10V.

Note 4. See V_{IN} derating graph in Typical Characteristics.

Note 5. The maximum frequency in this application is 300kHz. For higher frequency operation contact Zetex Applications Department.



ZXRD1000 SERIES

TYPICAL CHARACTERISTICS

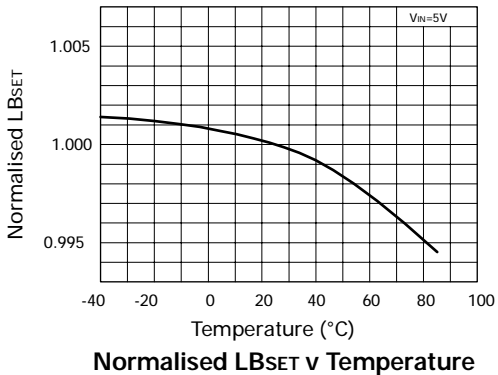
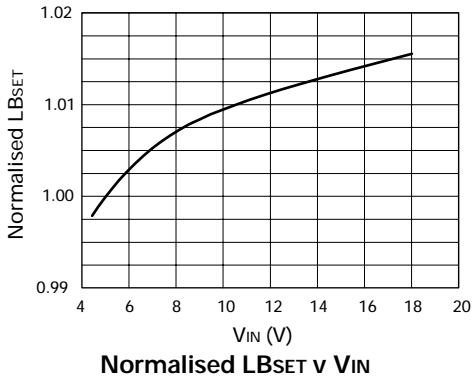
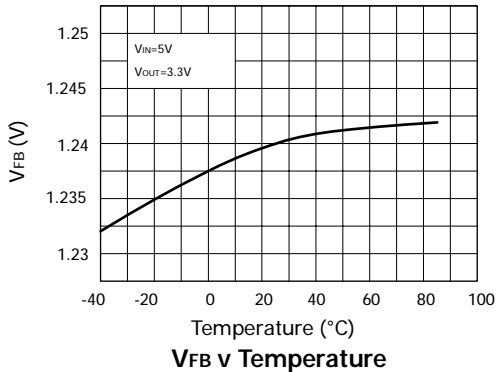
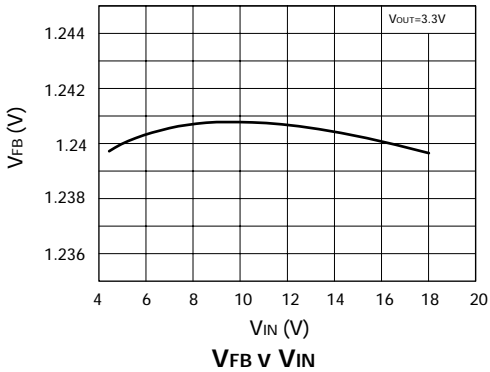
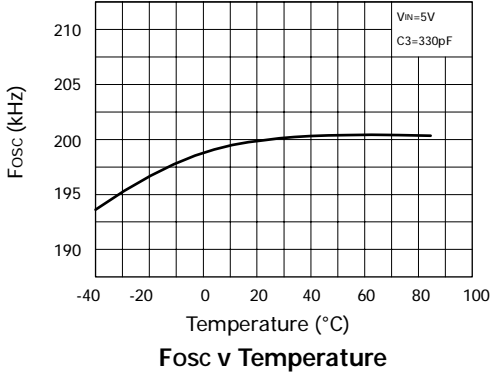
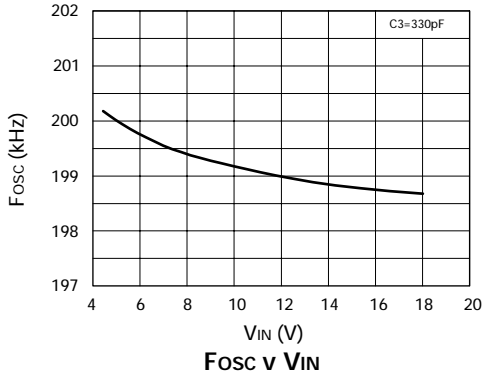

ZXRD1000 SERIES

TYPICAL CHARACTERISTICS

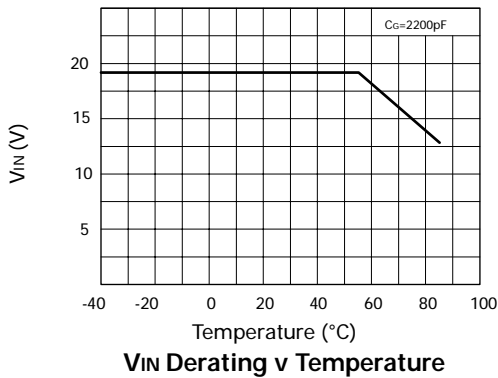
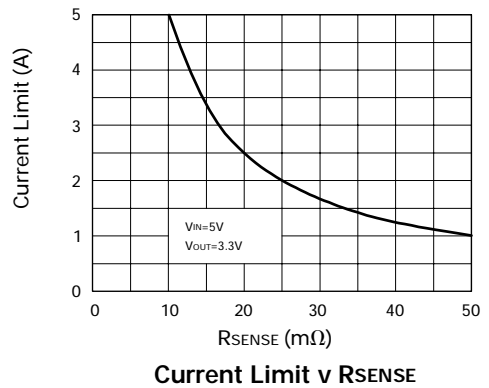
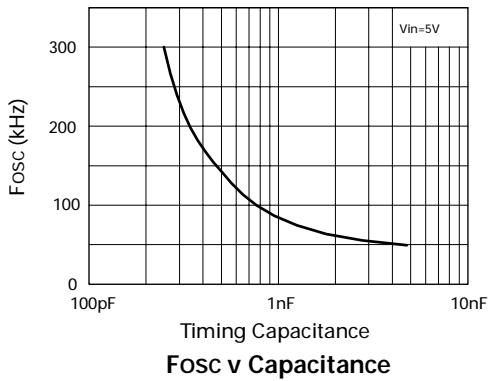
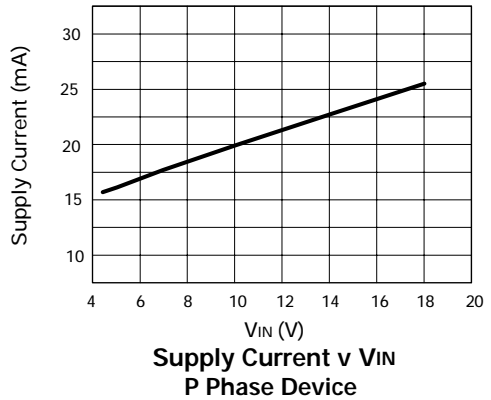
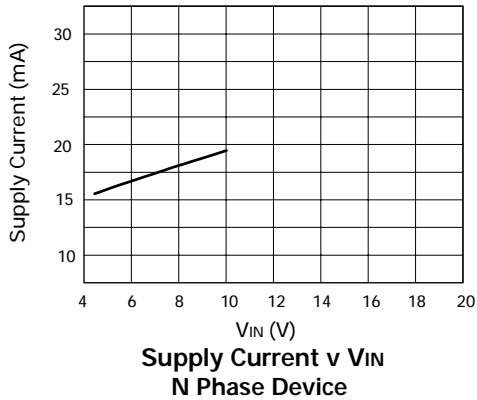

DETAILED DESCRIPTION

The ZXRD1000 series can be configured to use either N or P channel MOSFETs to suit most applications. The most popular format, an all N channel synchronous solution gives the optimum efficiency. A feature of the ZXRD1000 series solution is the unique method of generating the synchronous drive, called SimpleSync™. Most solutions use an additional output from the controller, inverted and delayed from the main switch drive. The ZXRD1000 series solution uses a simple overwinding on the main choke (wound on the same core at no real cost penalty) plus a small ferrite bead. This means that the synchronous FET is only enhanced when the main FET is turned off. This reduces the 'blanking period' required for shoot-through protection, increasing efficiency and allowing smaller catch diodes to be used, making the controller simpler and less costly by avoiding complex timing circuitry. Included on chip are numerous functions that allow flexibility to suit most applications. The nominal switching frequency (200kHz) can be adjusted by a simple timing capacitor, C3. A low battery detect circuit is also provided. Off the shelf components are available from major manufacturers such as Sumida to provide either a single winding inductor for non-synchronous applications or a coil with an over-winding for synchronous applications. The combination of these switching characteristics, innovative circuit design and excellent user flexibility, make the ZXRD1000 series DC-DC solutions some of the smallest and most cost effective and electrically efficient currently available. Using Zetex's HDMOS low $R_{DS(on)}$ devices, ZXM64N02X for the main and synchronous switch, efficiency can peak at upto 95% and remains high over a wide range of operating currents. Programmable soft start can also be adjusted via the capacitor, C7, in the compensation loop.

What is SimpleSync™?

Conventional Methods

In the conventional approach to the synchronous DC-DC solution, much care has to be taken with the timing constraints between the main and synchronous switching devices. Not only is this dependent upon individual MOSFET gate thresholds (which vary from device to device within data sheet limits and over temperature), but it is also somewhat dependent upon magnetics, layout and other parasitics. This normally means that significant 'dead time' has to be factored in to the design between the main and synchronous devices being turned off and on respectively. Incorrect application of dead time constraints can potentially lead to catastrophic short circuit conditions between V_{IN} and G_{ND} . For some battery operated

systems this can not only damage MOSFETs, but also the battery itself. To realise correct 'dead time' implementation takes complex circuitry and hence implies additional cost.

The ZETEX Method

Zetex has taken a different approach to solving these problems. By looking at the basic architecture of a synchronous converter, a novel approach using the main circuit inductor was developed. By taking the inverse waveform found at the input to the main inductor of a non-synchronous solution, a synchronous drive waveform can be generated that is always relative to the main drive waveform and inverted with a small delay. This waveform can be used to drive the synchronous switch which means no complex circuitry in the IC need be used to allow for shoot-through protection.

Implementation

Implementation was very easy and low cost. It simply meant peeling off a strand of the main inductor winding and isolating it to form a coupled secondary winding. These are available as standard items referred to in the applications circuits parts list. The use of a small, surface mount, inexpensive 'square loop' ferrite bead provides an excellent method of eliminating shoot-through due to variation in gate thresholds. The bead essentially acts as a high impedance for the few nano seconds that shoot-through would normally occur. It saturates very quickly as the MOSFETs attain steady state operation, reducing the bead impedance to virtually zero.

Benefits

The net result is an innovative solution that gives additional benefits whilst lowering overall implementation costs. It is also a technique that can be simply omitted to make a non-synchronous controller, saving further cost, at the expense of a few efficiency points.



ZXRD1000 SERIES

Functional Block Diagram

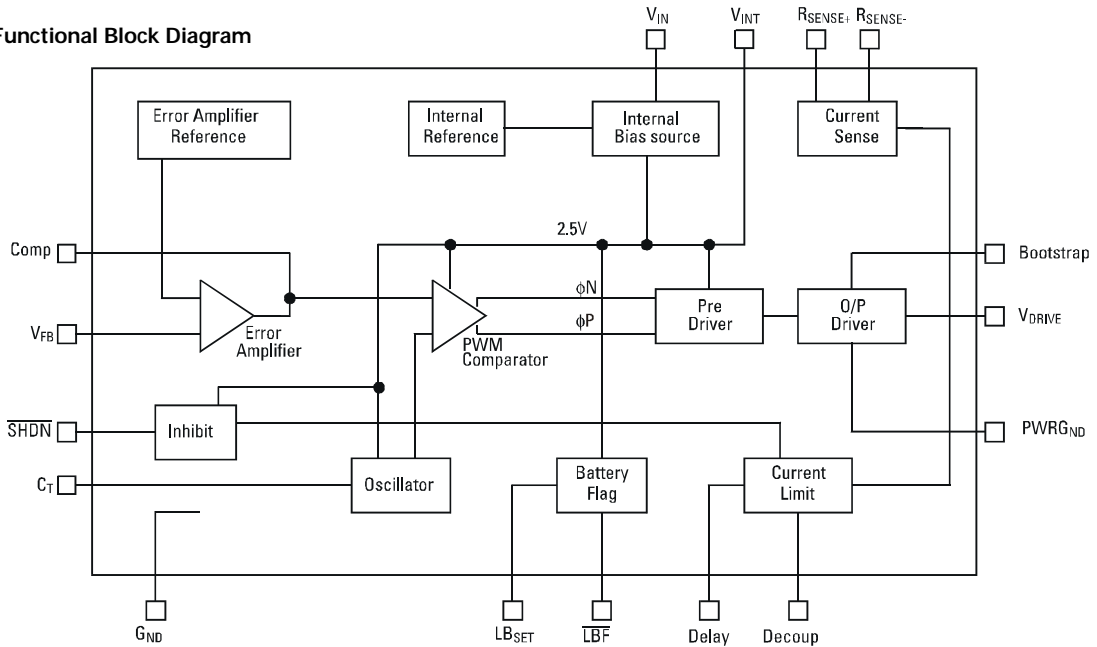

PIN DESCRIPTIONS		‡ See relevant Applications Section
Pin No.	Name	Description
1	Bootstrap	Bootstrap circuit for generating gate drive
2	V _{DRIVE}	Output to the gate drive circuit for main N/P channel switches
3	PWRG _{ND}	Power ground
4	G _{ND}	Signal ground
5	C _T	Timing Capacitor sets oscillator frequency. ‡
6	V _{INT}	Internal Bias Circuit. Decouple with 1µF ceramic capacitor
7	R _{SENSE+}	Higher potential input to the current sense for current limit circuit
8	R _{SENSE-}	Lower potential input to the current sense for current limit circuit
9	SHDN	Shutdown control. Active low.
10	Decoup	Optional short circuit and overload decoupling capacitor for increased accuracy
11	LBF	Low battery flag output. Active low, open collector output
12	LB _{SET}	Low battery flag set. Can be connected to V _{IN} if unused, or threshold set via potential divider. ‡
13	V _{IN}	Input Voltage
14	Delay	External R and C to set the desired cycle time for hiccup circuit. ‡
15	Comp	Compensation pin to allow for stability components and soft start. ‡
16	V _{FB}	Feedback Voltage. This pin has a different function between fixed and adjustable controller options. The appropriate controller must be used for the fixed or adjustable solution. Connect to V _{OUT} for fixed output, or to potential divider for adjustable output. ‡

Applications

Note: Component names refer to designators shown in the application circuit diagrams.

Output Capacitors

Output capacitors are a critical choice in the overall performance of the solution. They are required to filter the output and supply load transient current. They are also affected by the switching frequency, ripple current, di/dt and magnitude of transient load current. ESR plays a key role in determining the value of capacitor to be used. Combination of both high frequency, low value ceramic capacitors and low ESR bulk storage capacitors optimised for switching applications provide the best response to load transients and ripple requirements. Electrolytic capacitors with low ESR are larger and more expensive so the ultimate choice is always a compromise between size, cost and performance. Care must also be taken to ensure that for large capacitors, the ESL of the leads does not become an issue. Excellent low ESR tantalum or electrolytic capacitors are available from Sanyo OS-CON, AVX, Sprague and Nichicon.

The output capacitor will also affect loop stability, transient performance. The capacitor ESR should preferably be of a similar value to the sense resistor. Parallel devices may be required.

$$I_{\text{RIPPLE(RMS)}} = \frac{0.29 V_{\text{OUT}} (V_{\text{IN}} - V_{\text{OUT}})}{L f V_{\text{IN}}}$$

where L = output filter inductance
f = switching frequency

For output voltage ripple it is necessary to know the peak ripple current which is given by:

$$I_{\text{pk-pk}} = \frac{V_{\text{OUT}} (V_{\text{IN}} - V_{\text{OUT}})}{L f V_{\text{IN}}}$$

Voltage ripple is then:-

$$V_{\text{RIPPLE}} = I_{\text{pk-pk}} * \text{ESR}$$

Input Capacitors

The input capacitor is chosen for its RMS current and voltage rating. The use of low ESR electrolytic or tantalum capacitors is recommended. Tantalum capacitors should have their voltage rating at $2V_{\text{IN}}(\text{max})$, electrolytic at $1.4V_{\text{IN}}(\text{max})$. I_{RMS} can be approximated by:

$$I_{\text{RMS}} = I_{\text{OUT}} \frac{\sqrt{V_{\text{OUT}}(V_{\text{IN}} - V_{\text{OUT}})}}{V_{\text{IN}}}$$

Underspecification of this parameter can affect long term reliability. An additional ceramic capacitor should be used to provide high frequency decoupling at V_{IN} .

Also note that the input capacitance ESR is effectively in series with the input and hence contributes to efficiency losses related to $I_{\text{RMS}}^2 * \text{ESR}$ of the input capacitor.

MOSFET Selection

The ZXRD1000 family can be configured in circuits where either N or P channel MOSFETs are employed as the main switch. If an N channel device is used, the corresponding N phase controller must be chosen. Similarly, for P channel main switch a P phase controller must be used. The ordering information has a clear identifier to distinguish between N and P phase controllers.

The MOSFET selection is subject to thermal and gate drive considerations. Care also has to be taken to allow for transition losses at high input voltages as well as $R_{\text{DS(ON)}}$ losses for the main MOSFET. It is recommended that a device with a drain source breakdown of at least 1.2 times the maximum V_{IN} should be used.

For optimum efficiency, two N channel low $R_{\text{DS(ON)}}$ devices are required. MOSFETs should be selected with the lowest $R_{\text{DS(ON)}}$ consistent with the output current required. As a guide, for 3-4A output, <50mΩ devices would be optimum, provided the devices are low gate threshold and low gate charge. Typically look for devices that will be fully enhanced with 2.7V V_{GS} for 4-5A capability.

Zetex offers a range of low $R_{\text{DS(ON)}}$ logic level MOSFETs which are specifically designed with DC-DC power conversion in mind. Packaging includes SOT23, SOT23-6 and MSOP8 options. Ideal examples of optimum devices would be Zetex ZXM64N03X and ZXM64N02X (N channel). Contact your local Zetex office or Zetex web page for further information.



ZXRD1000 SERIES

Applications (continued)

Inductor Selection

The inductor is one of the most critical components in the DC-DC circuit. There are numerous types of devices available from many suppliers. Zetex has opted to specify off the shelf encapsulated surface mount components, as these represent the best compromise in terms of cost, size, performance and shielding.

The SimpleSync™ technique uses a main inductor with an overwinding for the gate drive which is available as a standard part. However, for engineers who wish to design their own custom magnetics, this is a relatively simple and low cost construction technique. It is simply formed by terminating one of the multiple strands of litz type wire separately. It is still wound on the same core as the main winding and only has to handle enough current to charge the gate of the synchronous MOSFET. The major benefit is circuit simplification and hence lower cost of the control IC. For non-synchronous operation, the overwinding is not required.

The choice of core type also plays a key role. For optimum performance, a 'swinging choke' is often preferred. This is one which exhibits an increase in inductance as load current decreases. This has the net effect of reducing circulating current at lighter load improving efficiency. There is normally a cost premium for this added benefit. For this reason the chokes specified are the more usual constant inductance type.

Peak current of the inductor should be rated to minimum $1.2I_{OUT(max)}$. To maximise efficiency, the winding resistance of the main inductor should be less than the main switch output on resistance.

Schottky Diode

Selection depends on whether a synchronous or non-synchronous approach is taken. For the ZXRD1000, the unique approach to the synchronous drive means minimal dead time and hence a small SOT23 1A DC rated device will suffice, such as the ZHCS1000 from Zetex. The device is only designed to prevent the body diode of the synchronous MOSFET from conducting during the initial switching transient until the MOSFET takes over. The device should be connected as close as possible to the source terminals of the main MOSFET.

For non-synchronous applications, the Schottky diode must be selected to allow for the worst case

conditions, when V_{IN} is at its highest and V_{OUT} is lowest (short circuit conditions for example). Under these conditions the device must handle peak current at close to 100% duty cycle.

Frequency Adjustment

The nominal running frequency of the controller is set to 200kHz in the applications shown. This can be adjusted over the range 50kHz to 300kHz by changing the value of capacitor on the C_T pin. A low cost ceramic capacitor can be used.

$$\text{Frequency} = 60000/C3 \text{ (pF)}$$

Frequency v temperature is given in the typical characteristics.

Output Voltage Adjustment

The ZXRD1000 is available as either a fixed 5V, 3.3V or adjustable output. On fixed output versions, the V_{FB} pin should be connected to the output. Adjustable operation requires a resistive divider connected as follows:

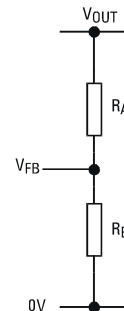

The value of the output voltage is determined by the equation

$$V_{OUT} = V_{FB} \left(1 + \frac{R_A}{R_B} \right) \quad V_{FB} = 1.24V$$

Note: The adjustable circuit is shown in the following transient optimisation section. It is also used in the evaluation PCB. In both these circuits R_A is assigned the label R6 and R_B the label R5.

Values of resistor should be between 1k and 20k to guarantee operation. Output voltage can be adjusted in the range 2V to 12V for non-synchronous applications. For synchronous applications, the minimum V_{OUT} is set by the V_{GS} threshold required for the synchronous MOSFET, as the swing in the gate using the SimpleSync™ technique is approximately V_{OUT} .

Applications (continued)

Low Battery Flag

The low battery flag threshold can be set by the user to trip at a level determined by the equation:

$$V_{LBSET} = 1.25 \left(1 + \frac{R_C}{R_D} \right)$$

R_D is recommended to be 10k where R_C and R_D are connected as follows:

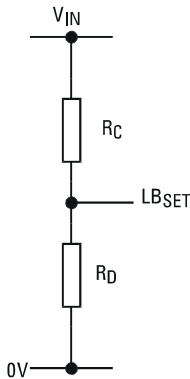

Hysteresis is typically 20mV at the LBSET pin.

Current Limit

A current limit is set by the low value resistor in the output path, R_{SENSE} . Since the resistor is only used for overload current limit, it does not need to be accurate and can hence be a low cost device.

The value of the current limit is set by using the equation:

$$I_{LIM} (A) = \frac{50(mV)}{R_{SENSE}(m\Omega)}$$

A graph of Current Limit v R_{SENSE} is shown in the typical characteristics. This should assist in the selection of R_{SENSE} appropriate to application.

If desired, R_{SENSE} can also be on the input supply side.

When used on the input side R_{SENSE} should be in series with the upper output device (i.e. in series with the drain or source in N and P channel solutions respectively). Typically in this configuration R_{SENSE} will be 20m Ω .

Hiccup Time Constant

The hiccup circuit (at the 'delay' pin) provides overload protection for the solution. The threshold of the hiccup mode is determined by the value of R_{SENSE} . When >50mV is developed across the sense resistor, the hiccup circuit is triggered, inhibiting the device.

It will stay in this state depending upon the time constant of the resistor and capacitor connected at the 'delay' pin. In order to keep the dissipation down under overload conditions it is recommended the circuit be off for approximately 100ms. If for other application reasons this is too long an off period, this can be reduced at least by 10:1, care needs to be taken that any increased dissipation in the external MOSFET is still acceptable. The resistor capacitor combination $R1, C1$ recommended in the applications circuits provides a delay of 100ms.

Soft Start & Loop Stability

Soft start is determined by the time constant of the capacitor and resistor $C7$ and $R3$. Typically a good starting point is $C7 = 22\mu F$ and $R3 = 24k$ for fixed voltage variants. For fully adjustable variants see Optimising for Transient Response later in the applications section. This network also helps provide good loop stability.

Low Quiescent Shutdown

Shutdown control is provided via the \overline{SHDN} pin, putting the device in to a low quiescent sleep mode. In some circumstances where rapid sequencing of V_{CC} can occur (when V_{CC} is turned off and back on) and V_{CC} has a very rapid rise time (100-200ms) timing conflicts can occur.

ZXRD1000 SERIES

Optimising for Transient Response.

Transient response is important in applications where the load current increases and decreases rapidly. To optimise the system for good transient response certain criteria have to be observed.

The optimum solution using the ZXRD series uses the adjustable N phase controller in synchronous mode as represented in the diagram opposite. The external networks for this solution require the use of the adjustable controller option.

By using standard 'bulk' capacitors in parallel with a single OS-CON capacitor significant performance versus cost advantage can be given in this application. The low ESR of the OS-CON capacitor provides competitive output voltage ripple at low capacitance values. The 'bulk' capacitors aid transient response. However, the low ESR of the OS-CON capacitor can cause instability within the system. To maintain stability an RC network (R_x , C_{x1}) has to be implemented. Furthermore, a capacitor in parallel with R_6 (C_{x2}) is required to optimise transient response. To do this the appropriate adjustable ZXRD must be used because the input to the internal error amplifier (pin 16) has to be accessed. The adjustable device differs from fixed controller versions in this respect. This combined with a frequency compensation adjustment gives an optimised solution for excellent transient response.

Layout Issues

Layout is critical for the circuit to function in the most efficient manner in terms of electrical efficiency, thermal considerations and noise. The following guidelines should be observed:

A 2.2 μ F (C8) decoupling capacitor should be as close as possible to the drive MOSFETs and D1 anode. This capacitor is effectively connected across V_{IN} and G_{ND} but should be as close as possible to the appropriate components in either N or P, synchronous or non-synchronous configurations. Furthermore the G_{ND} connection of the synchronous MOSFET/D1 and output capacitors should be close together and use either a ground plane or at the very least a low inductance PCB track.

For the standard application circuits, a Gerber file can be made available for the layout which uses the materials as listed in the bill of materials table for the reference designs.

Reference Designs.

In the following section reference circuits are shown for the ZXRD series in both synchronous and non-synchronous modes. These are shown for each of the N and P phase controllers. In each case efficiency graphs are shown for the appropriate configuration using 3.3V and 5V ZXRD devices. The BOM is then shown for the design. Additional and alternative components are shown with a '*'. These refer to modifications to the design to optimise for transient response. Optimisation is reached using the adjustable version of either N or P phase controller device.

ZXRD1000 SERIES

Ref	Value	Part Number	Manufacturer	Comments
IC1		ZXRD1033NQ16	Zetex	QSOP16 Controller IC
N1 $V_{IN}>7V$ N2 $V_{IN}<7V$		ZXM64N03X ZXM64N02X ZXM64N02X	Zetex	MSOP8 Low $R_{DS(ON)}$ N MOSFET 30V V_{DS} 20V V_{DS} 20V V_{DS}
D1	1A 0.5V V_F	ZHCS1000	Zetex	SOT23 Schottky Diode 1A
D2	10mA 0.4V V_F	BAT54	Zetex	SOT23 Schottky Diode
D3	10mA 0.4V V_F	BAT54	Zetex	SOT23 Schottky Diode
R1	100k	WCR0805-100k	Welwyn/IRC	0805 Size
R2	680 Ω	WCR0805-680	Welwyn/IRC	0805 Size
R3	24k	WCR0805-24k	Welwyn/IRC	0805 Size
*R3	3k	WCR0805-3k	Welwyn/IRC	0805 Size
R4	10k	WCR0805-10k	Welwyn/IRC	0805 Size
*Rx	2.7K	WCR0805-2.7k	Welwyn/IRC	0805 Size
R_{SENSE}	0.01 Ω	LR1206R010	Welwyn/IRC	Current Limit Sense Resistor
C_{IN} OR OR	68 μ F 68 μ F 68 μ F	TPSD68M016R0150 20SA68M 20SV68M	AVX Sanyo OS-CON Sanyo OS-CON	68 μ F 16V 'E' low ESR 68 μ F 20V PTH low ESR 68 μ F 20V SMT low ESR
C_{OUT} OR OR	470 μ F *150 μ F *120 μ F	TPSE477M010R0200 6SA150M 6SV120M	AVX Sanyo OS-CON Sanyo OS-CON	470 μ F 10V 'E' low ESR 150 μ F 6V PTH low ESR 120 μ F 6V SMT low ESR
C_{OUT}	680 μ F x 2	6CV680GX	Sanyo	680 μ F 6V SMT Bulk Capacitor
C1	1 μ F		Generic	1 μ F,10V.X7R Dielectric
C2	1 μ F		Generic	1 μ F,4V.X7R Dielectric
C3	330pF		Generic	330pF,4V.X7R Dielectric
C4	1 μ F		Generic	1 μ F,10V.X7R Dielectric
C5	1 μ F		Generic	1 μ F,10V.X7R Dielectric
C6	1 μ F		Generic	1 μ F,4V.X7R Dielectric
C7	22 μ F		Generic	22 μ F,4V.X7R Dielectric
C8	2.2 μ F		Generic	2.2 μ F,10V.X7R Dielectric
C9	1 μ F		Generic	1 μ F,10V.X7R Dielectric
C10	1 μ F		Generic	1 μ F,10V.X7R Dielectric
C11	1 μ F		Generic	1 μ F,10V.X7R Dielectric
*Cx1	0.022 μ F		Generic	0.022 μ F,4V.X7R Dielectric
*Cx2	10nF		Generic	10nF,10V.X7R Dielectric
L1 OR	15 μ H 10 μ H	CDRH127B-OWZ9 6001	Sumida SMT C&D Technologies (NCL)	Low Profile SMT Low Profile SMT
Fx		2785044447	FairRite	SMT Ferrite Bead

* see Optimising for Transient Response Section



ZXRD1000 SERIES

4.5V -10V Input, 3.3V/4A Output, N Phase, High Efficiency Non-Synchronous Step Down Converter 200kHz

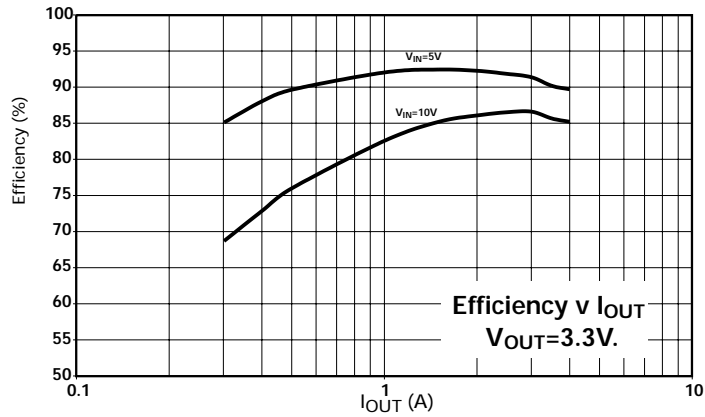
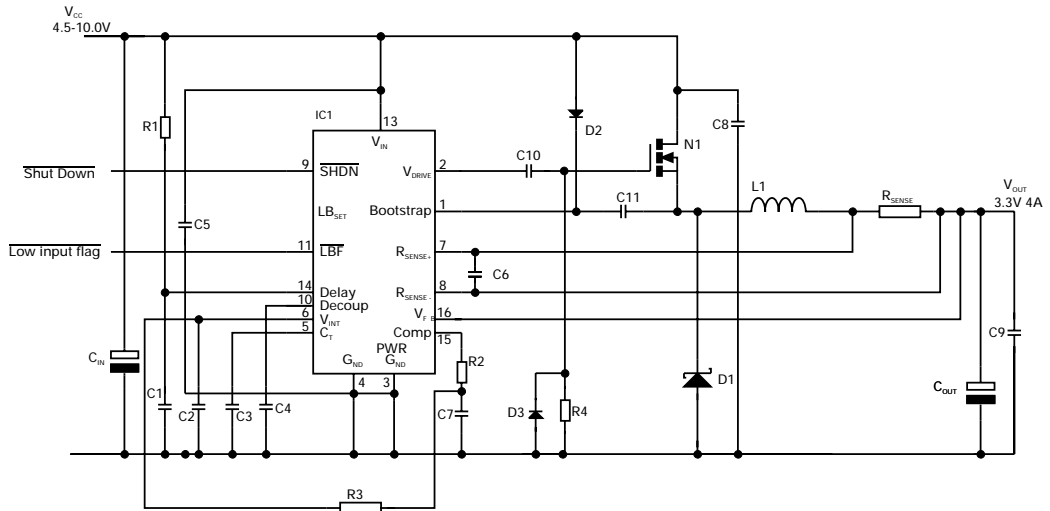

ZXRD1033NQ16

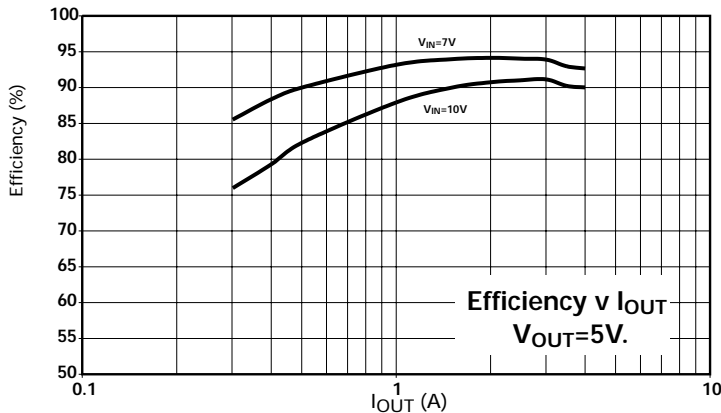

ZXRD1050NQ16



ZXRD1000 SERIES

Ref	Value	Part Number	Manufacturer	Comments
IC1		ZXRD1033NQ16	Zetex	QSOP16 Controller IC
N1 $V_{IN}>7V$ $V_{IN}<7V$		ZXM64N03X ZXM64N02X	Zetex	MSOP8 Low $R_{DS(ON)}$ N MOSFET $30V V_{DS}$ $20V V_{DS}$
D1	5A 0.5V V_F	50WQ04FN	Zetex	Schottky Diode 5A
D2	10mA 0.4V V_F	BAT54	Zetex	SOT23 Schottky Diode
D3	10mA 0.4V V_F	BAT54	Zetex	SOT23 Schottky Diode
R1	100k	WCR0805-100k	Welwyn/IRC	0805 Size
R2	680 Ω	WCR0805-680	Welwyn/IRC	0805 Size
R3	24k	WCR0805-24k	Welwyn/IRC	0805 Size
*R3	3k	WCR0805-3k	Welwyn/IRC	0805 Size
R4	10k	WCR0805-10k	Welwyn/IRC	0805 Size
*Rx	2.7K	WCR0805-2.7k	Welwyn/IRC	0805 Size
R_{SENSE}	0.01 Ω	LR1206R010	Welwyn/IRC	Current Limit Sense Resistor
C_{IN} OR OR	68 μ F 68 μ F 68 μ F	TPSC68M02R0150 20SA68M 20SV68M	AVX Sanyo OS-CON Sanyo OS-CON	68 μ F 25V 'E' low ESR 68 μ F 20V PTH low ESR 68 μ F 20V SMT low ESR
C_{OUT} OR OR	470 μ F *150 μ F *120 μ F	TPSE477M010R0200 6SA150M 6SV120M	AVX Sanyo OS-CON Sanyo OS-CON	470 μ F 10V 'E' low ESR 150 μ F 6V PTH low ESR 120 μ F 6V SMT low ESR
C_{OUT}	680 μ F x 2	6CV680GX	Sanyo	680 μ F 6V SMT Bulk Capacitor
C1	1 μ F		Generic	1 μ F, 10V.X7R Dielectric
C2	1 μ F		Generic	1 μ F, 4V.X7R Dielectric
C3	330pF		Generic	330pF, 4V.X7R Dielectric
C4	1 μ F		Generic	1 μ F, 10V.X7R Dielectric
C5	1 μ F		Generic	1 μ F, 10V.X7R Dielectric
C6	1 μ F		Generic	1 μ F, 4V.X7R Dielectric
C7	22 μ F		Generic	22 μ F, 4V.X7R Dielectric
C8	2.2 μ F		Generic	2.2 μ F, 10V.X7R Dielectric
C9	1 μ F		Generic	1 μ F, 10V.X7R Dielectric
C10	1 μ F		Generic	1 μ F, 10V.X7R Dielectric
C11	1 μ F		Generic	1 μ F, 10V.X7R Dielectric
*Cx1	0.022 μ F		Generic	0.022 μ F, 4V.X7R Dielectric
*Cx2	10nF		Generic	10nF, 10V.X7R Dielectric
L1 OR	15 μ H 15 μ H	CDRH127-150MC DP5022P-153	Sumida Coilcraft	Low Profile SMT Low Profile SMT

* see Optimising for Transient Response Section



ZXRD1000 SERIES

5V -18V Input, 5V/3A Output, P Phase, High Efficiency SimpleSync™ Converter 200kHz

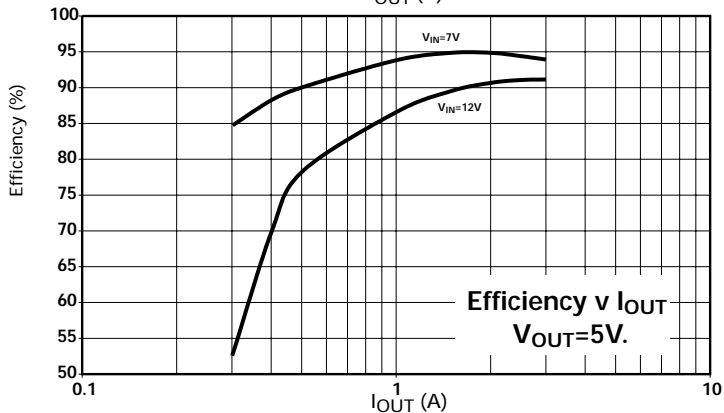
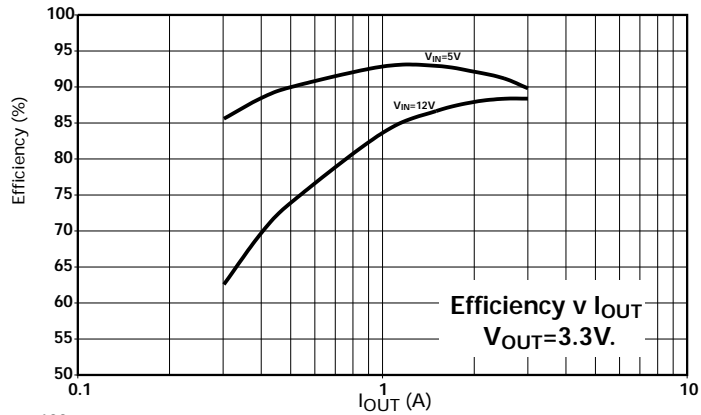
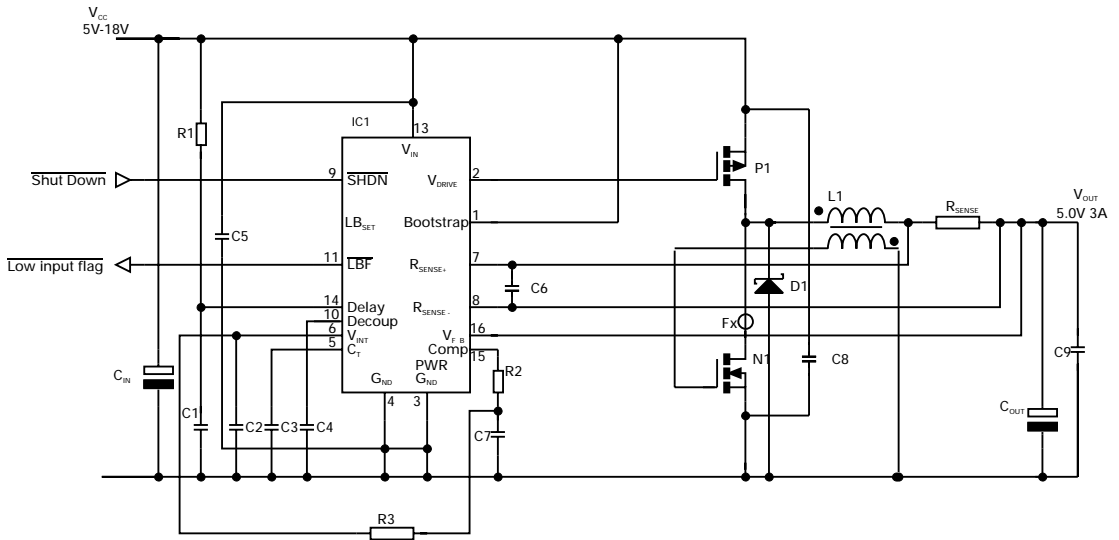

ZXRD1000 SERIES

Ref	Value	Part Number	Manufacturer	Comments
IC1		ZXRD1050PQ16	Zetex	QSOP16 Controller IC
P1 $V_{IN}>12V$ $V_{IN}<12V$		ZXM64P03X ZXM64P02X	Zetex	MSOP8 Low $R_{DS(ON)}$ P MOSFET $30V V_{DS}$ $20V V_{DS}$
N1		ZXM64NO3X	Zetex	MSOP8 Low $R_{DS(ON)}$ MOSFET
D1	1A 0.5V V_F	ZHCS1000	Zetex	Schottky Diode 1A
R1	100k	WCR0805-100k	Welwyn/IRC	0805 Size
R2	680 Ω	WCR0805-680	Welwyn/IRC	0805 Size
R3	24k	WCR0805-24k	Welwyn/IRC	0805 Size
*R3	3k	WCR0805-3k	Welwyn/IRC	0805 Size
*Rx	2.7K	WCR0805-2.7k	Welwyn/IRC	0805 Size
R_{SENSE}	0.015 Ω	LR1206R015	Welwyn/IRC	Current Limit Sense Resistor
C_{IN} OR OR	68 μ F 68 μ F 68 μ F	TPSV686M025R0150 20SA68M 20SV68M	AVX Sanyo OS-CON Sanyo OS-CON	68 μ F 25V 'E' low ESR 68 μ F 20V PTH low ESR 68 μ F 20V SMT low ESR
C_{OUT} OR OR	470 μ F *150 μ F *120 μ F	TPSE477M010R0200 6SA150M 6SV120M	AVX Sanyo OS-CON Sanyo OS-CON	470 μ F 10V 'E' low ESR 150 μ F 6V PTH low ESR 120 μ F 6V SMT low ESR
C_{OUT}	680 μ F x 2	6CV680GX	Sanyo	680 μ F 6V SMT Bulk Capacitor
C1	1 μ F		Generic	1 μ F,20V.X7R Dielectric
C2	1 μ F		Generic	1 μ F,4V.X7R Dielectric
C3	330pF		Generic	330pF,4V.X7R Dielectric
C4	1 μ F		Generic	1 μ F,20V.X7R Dielectric
C5	1 μ F		Generic	1 μ F,20V.X7R Dielectric
C6	1 μ F		Generic	1 μ F,4V.X7R Dielectric
C7	22 μ F		Generic	22 μ F,4V.X7R Dielectric
C8	2.2 μ F		Generic	2.2 μ F,20V.X7R Dielectric
C9	1 μ F		Generic	1 μ F,20V.X7R Dielectric
*Cx1	0.022 μ F		Generic	0.022 μ F,4V.X7R Dielectric
*Cx2	10nF		Generic	10nF,20V.X7R Dielectric
L1 OR	15 μ H 10 μ H	CDRH127B-OWZ9 6001	Sumida C&D Technologies (NCL)	Low Profile SMT Low Profile SMT
Fx		2785044447	FairRite	SMT Ferrite Bead

* see Optimising for Transient Response Section

ZXRD1000 SERIES

5V -18V Input, 5V/3A Output, P Phase, High Efficiency Non-synchronous Step Down Converter 200kHz

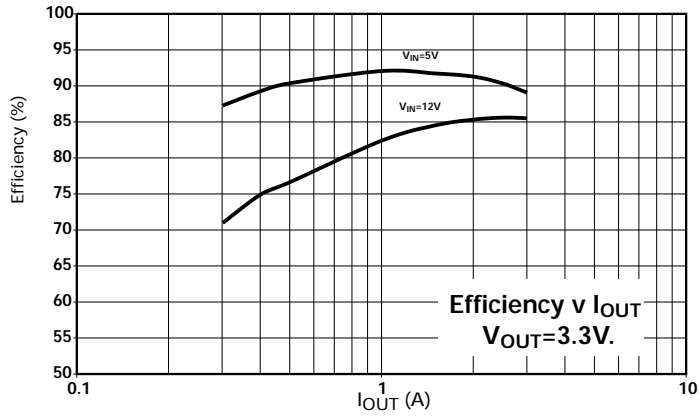
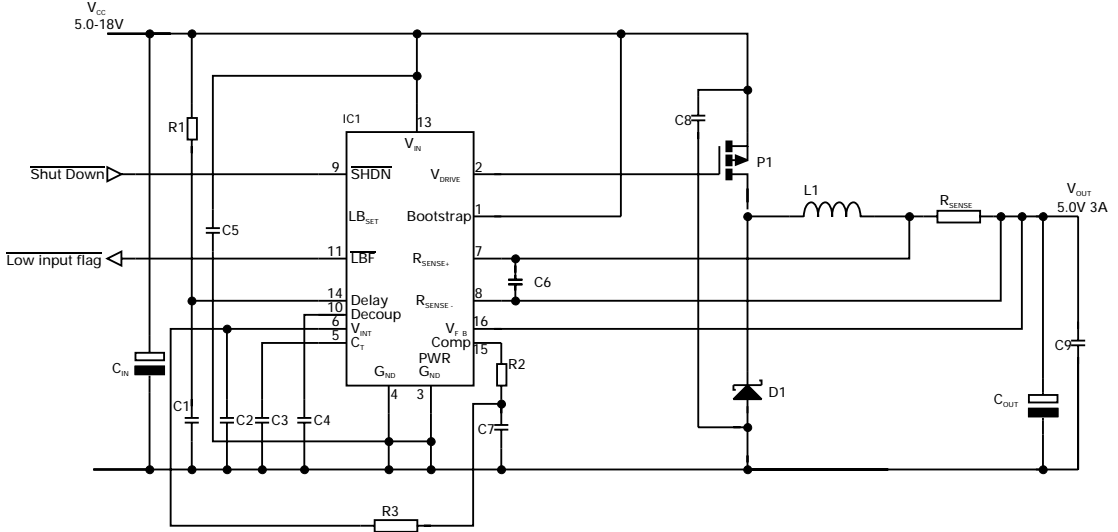

ZXRD1033PQ16

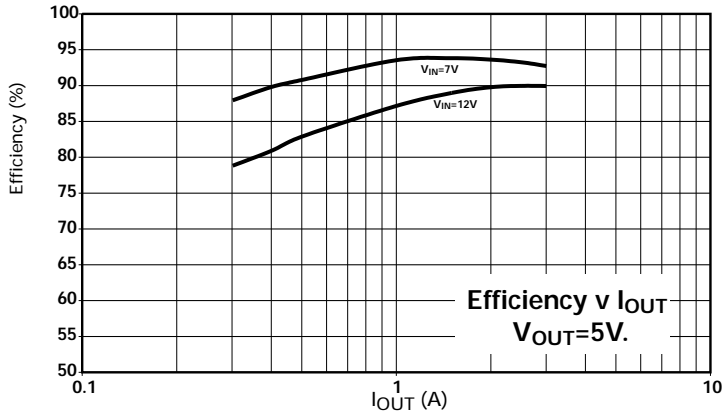

ZXRD1050PQ16



ZXRD1000 SERIES

Ref	Value	Part Number	Manufacturer	Comments
IC1		ZXRD1050PQ16	Zetex	QSOP16 Controller IC
P1 $V_{IN}>12V$ $V_{IN}<12V$		ZXM64P03X ZXM64P02X	Zetex	MSOP8 Low $R_{DS(ON)}$ P MOSFET $30V V_{DS}$ $20V V_{DS}$
D1	5A 0.5V V_F	50WQ04FN	IR	Schottky Diode 5A
R1	100k	WCR0805-100k	Welwyn/IRC	0805 Size
R2	680 Ω	WCR0805-680	Welwyn/IRC	0805 Size
R3	24k	WCR0805-24k	Welwyn/IRC	0805 Size
*R3	3k	WCR0805-3k	Welwyn/IRC	0805 Size
*Rx	2.7k	WCR0805-2.7k	Welwyn/IRC	0805 Size
R_{SENSE}	0.015 Ω	LR1206R015	Welwyn/IRC	Current Limit Sense Resistor
C_{IN} OR OR	68 μ F 68 μ F 68 μ F	TPSV686M025R0150 20SA68M 20SV68M	AVX Sanyo OS-CON Sanyo OS-CON	68 μ F 25V 'E' low ESR 68 μ F 20V PTH low ESR 68 μ F 20V SMT low ESR
C_{OUT} OR OR	470 μ F *150 μ F *120 μ F	TPSE477M010R0200 6SA150M 6SV120M	AVX Sanyo OS-CON Sanyo OS-CON	470 μ F 10V 'E' low ESR 150 μ F 6V PTH low ESR 120 μ F 6V SMT low ESR
C_{OUT}	680 μ F x 2	6CV680GX	Sanyo	680 μ F 6V SMT Bulk Capacitor
C1	1 μ F		Generic	1 μ F, 20V. X7R Dielectric
C2	1 μ F		Generic	1 μ F, 4V. X7R Dielectric
C3	330pF		Generic	330pF, 4V. X7R Dielectric
C4	1 μ F		Generic	1 μ F, 20V. X7R Dielectric
C5	1 μ F		Generic	1 μ F, 20V. X7R Dielectric
C6	1 μ F		Generic	1 μ F, 4V. X7R Dielectric
C7	22 μ F		Generic	22 μ F, 4V. X7R Dielectric
C8	2.2 μ F		Generic	2.2 μ F, 20V. X7R Dielectric
C9	1 μ F		Generic	1 μ F, 20V. X7R Dielectric
*Cx1	0.022 μ F		Generic	0.022 μ F, 4V. X7R Dielectric
*Cx2	10nF		Generic	10nF, 20V. X7R Dielectric
L1	15 μ H 15 μ H	CDRH127-150MC D05022P-153	Sumida SMT Coilcraft	Low Profile SMT Low Profile SMT

* see Optimising for Transient Response Section



ZXRD1000 SERIES

Designing with the ZXRD and Dynamic Performance

This section refers to the reference design for the 3.3V, 4A output N channel synchronous converter. This is as shown previously in the Optimising for transient response section of the applications information (page 10). This circuit is also representative of the ZXRD evaluation board (see ordering information).

The ZXRD series has been designed to give the best in terms of all round flexibility allowing engineers to either use the reference design as is, or to tailor the design to the individual requirements. This section demonstrates the performance features of the ZXRD series and its associated components.

Efficiency

Efficiency is often quoted as one of the key parameters of a DC-DC converter. Not only does it give an instantaneous idea of heat dissipation, but also an idea as to the extent battery life can be extended in say portable applications. Fig.1 shows the efficiency of the standard application circuit. Efficiency vs Output current is shown for the 5 to 3.3V configuration.

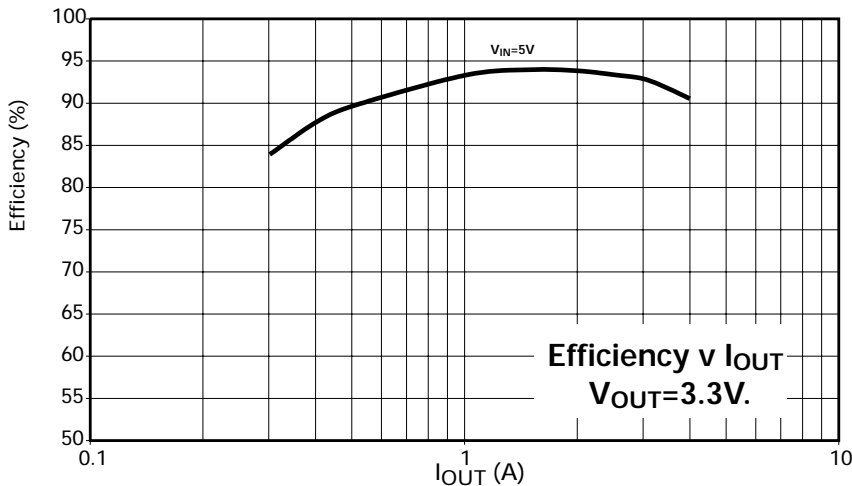

Fig.1. 5-3.3V Efficiency to 4A

Startup

Startup is always important in DC-DC converter applications. Magnetics have large inrush current requirements. For higher current applications using large input and output capacitors the startup current can be quite significant. This can cause several problems.

In many applications the power supply to the DC-DC converter can be affected. Particularly in battery powered applications, trying to take large steps in load current out of the supply can result in either current limitation (by the internal impedance of the battery), or it can actually damage the battery.

For the converter itself, large changes in load current can result in false triggering of the RSENSE circuit. This could result in device hiccup (see applications section).

The ZXRD programmable soft start function eliminates both these problems. This is very clear to see in operation if the main switching waveforms are examined.

The soft start is programmed by the combination of resistor and capacitor R3 and C7. As a recommendation, R3 and C7 are set to 3k and 22 μ F respectively, which limits the peak startup current appropriately in the reference circuit. Fig.2 shows the startup waveforms. V_{IN} and V_{OUT} are plotted against time

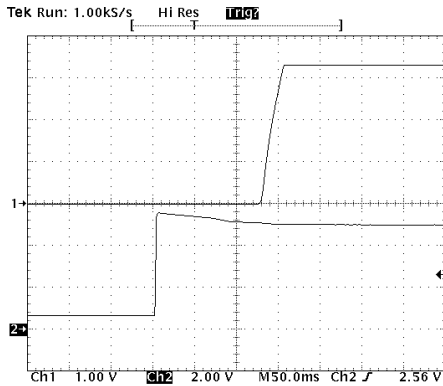

Fig.2. Startup Waveform for 3.3V output .

SimpleSync™ and Shoot-Through

Steady state operation under constant load gives an excellent indication of the ZXRD series performance and also demonstrates how well SimpleSync™ works. The SimpleSync™ technique drives the synchronous MOSFET gate using the overwinding on the main inductor. It also uses the high speed suppression characteristics of the ferrite bead to prevent shoot through currents. Fig.3 shows the gate waveforms for the main and synchronous MOSFET devices (Zetex ZXM64N02X).

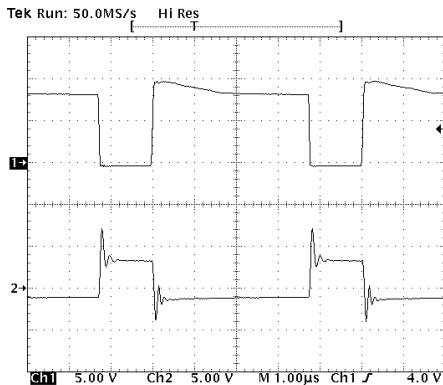

Fig3. Main & Synchronous gate waveforms

Output Voltage Ripple

Output voltage ripple is shown in Fig.4 and Fig. 5 for load currents of 0.5A and 4A respectively. Output voltage ripple will be dependant, to a very large extent, on the output capacitor ESR. (see Applications Section for ripple calculation).

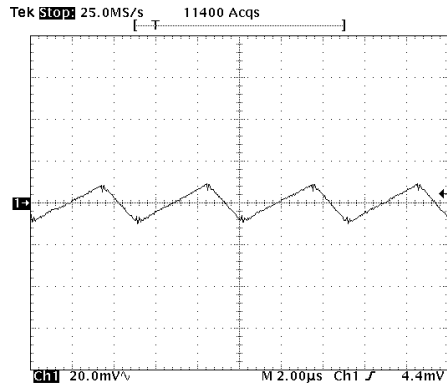

Fig.4 0.5A Main & V_{OUT} Waveforms

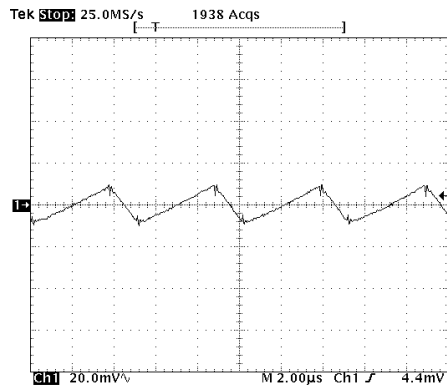

Fig.5 4A Main & V_{OUT} Waveforms

ZXRD1000 SERIES

Line regulation

Variation in input voltage for both these conditions (0.5A and 4A output) shows the excellent line regulation the ZXRD. Fig.6 shows that with 0.5A and 4A output currents, applying an increase in input voltage from 5V to 10V, results in only small changes in output regulation.

Fig.6a Line Regulation 0.5A load

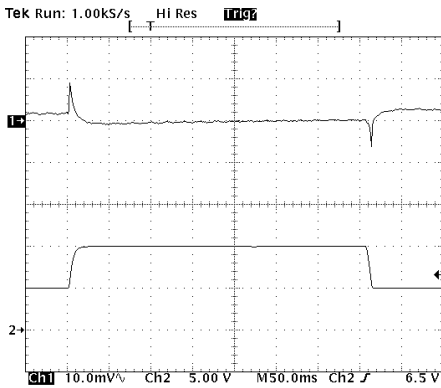
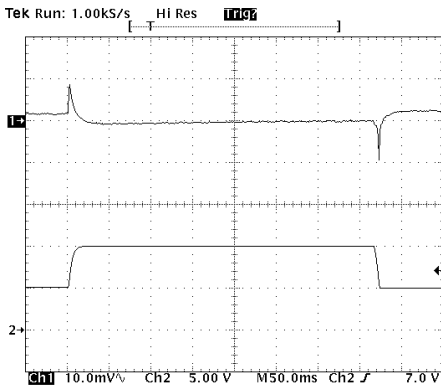

Fig.6b Line Regulation 4A load



Transient Response

Transient response to changes in load is becoming an increasingly critical feature of many converter circuits. Many high speed processors make very large step changes in their load requirements, at the same time as having more stringent specifications in terms of overshoot and undershoot. Fig.7 demonstrates the excellent load transient performance of the ZXRD series. A step change using an electronic load from 1A to 3A is shown with corresponding output transient performance.

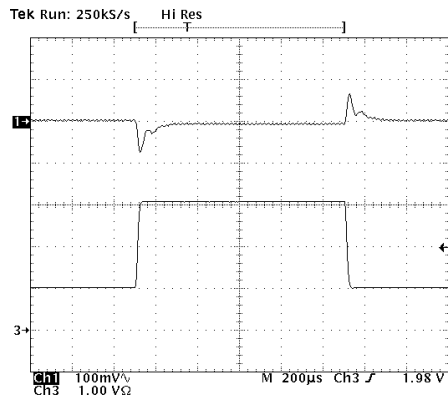

Fig.7 Output Transient Response

Non-synchronous Applications

One of the key features of the ZXRD series, when combined with the SimpleSync™ technique, is the flexibility in allowing engineers to choose either a synchronous or non-synchronous architecture.

Making the design non-synchronous by removing MOSFET N2 (the synchronous device), replacing the ZHCS1000 with a high current diode (50WQ04FN) and using a 2 terminal inductor, such as the Sumida CDRH127-150MC, decreases cost slightly at the expense of a few efficiency points. Fig.8 shows the effect on the efficiency of the 5 to 3.3V 4A application when the design is made non-synchronous.

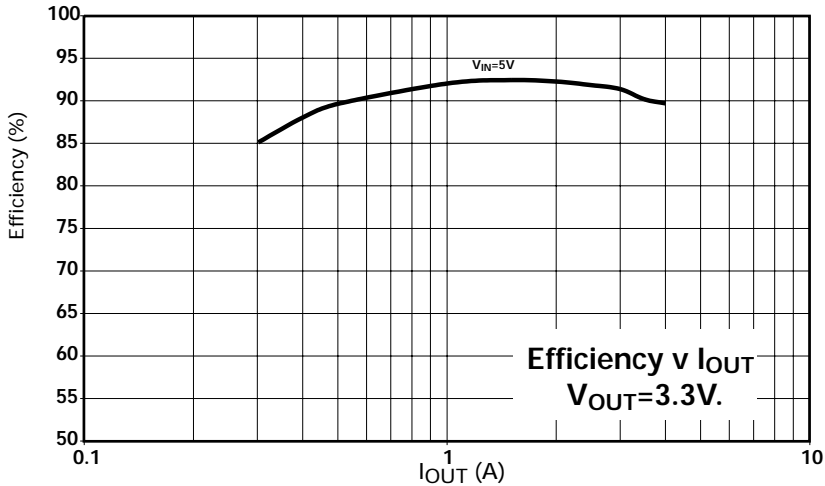

Fig.8 Efficiency for non-synchronous 5-3.3V conversion

Using 'P' Channel Devices (No Bootstrap)

All the preceding examples utilise N channel MOSFET devices and a bootstrap circuit to provide full enhancement to the high side device. These circuits have a maximum input voltage of 10V. For applications requiring a higher input voltage, using P channel devices for the main MOSFET will allow up to 18V operation. Typically this may be in a 12V to 5V converter circuit.

If the same package size MOSFET devices are used, it is likely a higher on resistance will be encountered, with the result that efficiency will decline slightly.

Fig 9 shows the efficiency plot for a P phase synchronous 5V converter based on the ZXRD1050PQ16. The figure charts efficiency v output current at 12V input and 7V input.

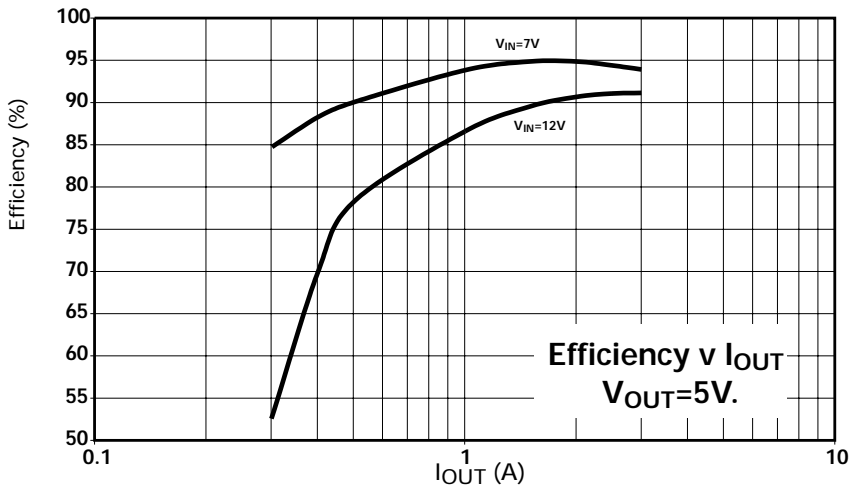

Fig.9 'P' Channel Device Efficiency (synchronous)

ZXRD1000 SERIES

ZXCM6 Series Low voltage MOSFETs

Unique structure gives optimum performance for switching applications.

N channel devices offer high efficiency performance for switching applications.

This family of MOSFETs from Zetex offers a combination of low on-resistance and low gate charge, providing optimum performance and high efficiency for switching applications such as DC - DC conversion.

On resistance is low across the family, from only 40m Ω (max) for the ZXM64N02X part up to 180m Ω (max) for the ZXM61N02F. This means that on-state losses are minimised, improving efficiency in low frequency drive applications. Threshold voltages of 0.7V and 1V minimum allow the MOSFETs to be driven from low voltage sources.

To minimise switching losses, and hence increase the efficiency of high frequency operation, gate charge (Qg) is small. The maximum Qg varies from 3.4nC to 16nC depending on which device is chosen. C_{rss} (Miller capacitance) is also low, e.g. typically 30pF for the ZXM6203E6 device. This results in better efficiency in high frequency applications.

P channel MOSFETs excel in load switching applications.

The P-channel MOSFETs offer highly efficient performance for low voltage load switching applications. This helps increase battery life in portable equipment.

Minimum threshold voltage is low, only 0.7V or 1V, enabling the MOSFETs to provide optimum performance from a low voltage source. To ensure the device suitability for low voltage applications, drain to source voltage is specified at 20V or 30V.

To minimise on-state losses, and improve efficiency in low frequency drive applications, the on-resistance (R_{DS(ON)}) is low across the range. For example, the ZXM64P03X has an R_{DS(ON)} of only 100m Ω at a gate to source voltage of 4.5V.

Gate source charge is also low, easing requirements for the gate driver. Maximum values range from 0.62nC for the ZXM61P03F, up to 9nC for the ZXM64P03X.

Small outline surface mount packaging

The products have been designed to optimise the performance of a range of packages. The parts are offered in SOT23, SOT23-6 and MSOP8 packages. The MSOP8 enables single or dual devices to be offered. The MSOP8 is also half the size of competitive SO8 devices and 20% smaller than TSSOP8 alternatives.

Product performance

The following performance characteristics show the capabilities of the ZXM64N02X. This device is recommended for use with certain configurations of the ZXRD DCDC controller circuit.

ZXRD1000 SERIES

Performance Characterisation of ZXM64N02X

ELECTRICAL CHARACTERISTICS (at $T_{amb} = 25^{\circ}\text{C}$ unless otherwise stated).

PARAMETER	SYMBOL	MIN.	TYP.	MAX.	UNIT	CONDITIONS.
STATIC						
Drain-Source Breakdown Voltage	$V_{(BR)DSS}$	20			V	$I_D=250\mu\text{A}, V_{GS}=0\text{V}$
Zero Gate Voltage Drain Current	I_{DSS}			1	μA	$V_{DS}=20\text{V}, V_{GS}=0\text{V}$
Gate-Body Leakage	I_{GSS}			100	nA	$V_{GS}=\pm 12\text{V}, V_{DS}=0\text{V}$
Gate-Source Threshold Voltage	$V_{GS(th)}$	0.7			V	$I_D=250\mu\text{A}, V_{DS}=V_{GS}$
Static Drain-Source On-State Resistance (1)	$R_{DS(on)}$			0.040 0.050	Ω	$V_{GS}=4.5\text{V}, I_D=3.8\text{A}$ $V_{GS}=2.7\text{V}, I_D=1.9\text{A}$
Forward Transconductance (3)	g_{fs}	6.1			S	$V_{DS}=10\text{V}, I_D=1.9\text{A}$
DYNAMIC (3)						
Input Capacitance	C_{iss}		1100		pF	$V_{DS}=15\text{V}, V_{GS}=0\text{V}, f=1\text{MHz}$
Output Capacitance	C_{oss}		350		pF	
Reverse Transfer Capacitance	C_{rss}		100		pF	
SWITCHING(2) (3)						
Turn-On Delay Time	$t_{d(on)}$		5.7		ns	$V_{DD}=10\text{V}, I_D=3.8\text{A}$ $R_G=6.2\Omega, R_D=2.6\Omega$ (Refer to test circuit)
Rise Time	t_r		9.6		ns	
Turn-Off Delay Time	$t_{d(off)}$		28.3		ns	
Fall Time	t_f		11.6		ns	
Total Gate Charge	Q_g			16	nC	$V_{DS}=16\text{V}, V_{GS}=4.5\text{V}$ $I_D=3.8\text{A}$ (Refer to test circuit)
Gate-Source Charge	Q_{gs}			3.5	nC	
Gate Drain Charge	Q_{gd}			5.4	nC	
SOURCE-DRAIN DIODE						
Diode Forward Voltage (1)	V_{SD}			0.95	V	$T_J=25^{\circ}\text{C}, I_S=3.8\text{A}, V_{GS}=0\text{V}$
Reverse Recovery Time (3)	t_{rr}		23.7		ns	$T_J=25^{\circ}\text{C}, I_F=3.8\text{A}, di/dt=100\text{A}/\mu\text{s}$
Reverse Recovery Charge(3)	Q_{rr}		13.3		nC	

(1) Measured under pulsed conditions. Width=300 μs . Duty cycle 2% .

(2) Switching characteristics are independent of operating junction temperature.

(3) For design aid only, not subject to production testing.



ZXRD1000 SERIES

208221 b8066

	GERMANY	ASIA	USA	UK
Zetex	Zetex GmbH Munich	Zetex Asia Hong Kong	Zetex Inc Long Island NY	Zetex PLC Chadderton, Oldham
	(49) 894549490	(852) 2610 0611	(1) 631 543 7100	(44) 161 622 4444
	http://www.zetex.com			
Sumida		Sumida Electric HK (852) 2880 6688	Sumida Electric USA (CHICAGO Head Office)	Ole Wolf Electronics Ltd.
		Taiwan Sumida Electric (886) 2762 2177	(1) 847 956-0666	(44) 1525 290755
	http://www.japanlink.com/sumida/			
FairRite	Schaffner Elektronik GmbH (49) 72156910	Fair Rite Asia Pte Ltd Singapore (65) 281 1969 Japan/Korea (81) 332255055	FairRite Products Corp (1) 914 895 2055	Schaffner EMC Ltd (44) 118 977 0070
AVX		AVX Asia Singapore (65) 258 2833	AVX USA (1) 843 448 9411	AVX UK (44) 1252 770000
	http://www.avxcorp.com			
Welwyn, IRC	Welwyn Electronics GmbH (49)871 973760	TTC Group plc Singapore (65) 536 51667	IRC Inc (1) 512 992 7900	Welwyn Components Ltd (44) 1670 822181
	http://welwyn-tt.co.uk			
Coilcraft			Coilcraft Inc (1) 847 639 6400	Coilcraft Europe (44) 1236 730595
	http://www.coilcraft.com			
Sanyo Electronic Comp. (OS-CON)	Sanyo Europe Munich (49) 89 457693 16	SANYO Electronics Ltd. Hong Kong (852) 21936888 Singapore (65) 281 3226 Japan (81) 720 70 6306	SANYO Electronics Ltd. Forrest City, AR 870 633 5030 San Diego, CA 619 661 6835 Rochelle Pk, NJ 201 843 8100	Semicon UK Ltd (44) 1279 422224
	http://www.sanyovideo.com			
C & D Technologies (NCL)	Contact C & D Technologies (NCL) UK	C & D Technologies Guangzhou, Guangdong, PRC (86) 208221 8066	C & D Technologies (NCL) 5816 Creedmoor Road, Raleigh North Carolina 27612 (1) 919 571 9405	C & D Technologies (NCL) Tanners Drive Blakelands North Milton Keynes MK14 5BU (44) 1908 615232
	http://www.dc-dc.com			



ZXRD1000 SERIES

Connection Diagram

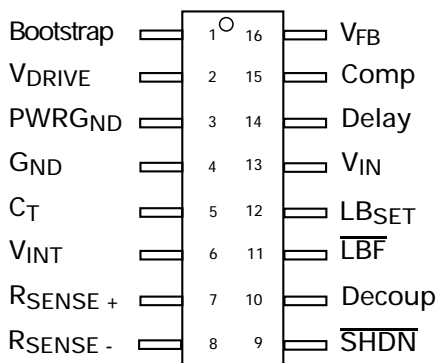

Note:

Connection diagram is the same for N and P Phase, adjustable and fixed controllers. The V_{FB} pin has a different function between adjustable and fixed versions.

Package Dimensions

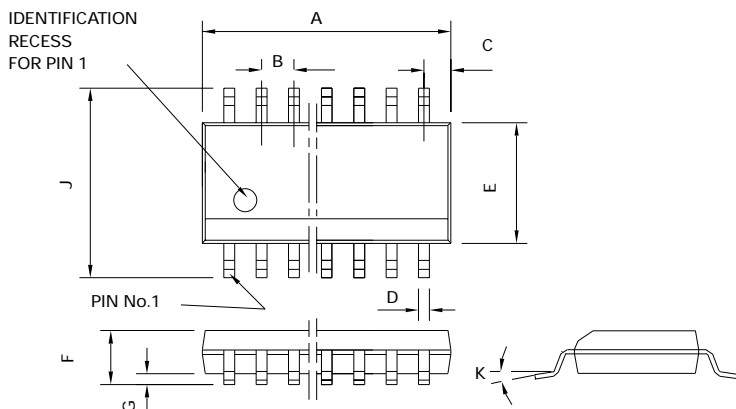

DIM	Millimetres		Inches	
	MIN	MAX	MIN	MAX
A	4.80	4.98	0.189	0.196
B	0.635		0.025 NOM	
C	0.177	0.267	0.007	0.011
D	0.20	0.30	0.008	0.012
E	3.81	3.99	0.15	0.157
F	1.35	1.75	0.053	0.069
G	0.10	0.25	0.004	0.01
J	5.79	6.20	0.228	0.244
K	0°	8°	0°	8°

ZXRD1000 SERIES

Ordering Information

Device	Description	T&R Suffix	Partmarking
ZXRD1033NQ16	3.3V Fixed controller N main switch	TA, TC	ZXRD1033N
ZXRD1050NQ16	5.0V Fixed controller N main switch	TA, TC	ZXRD1050N
ZXRD100ANQ16	Adjustable controller N main switch	TA, TC	ZXRD100AN
ZXRD1033PQ16	3.3V Fixed controller P main switch	TA, TC	ZXRD1033P
ZXRD1050PQ16	5.0V Fixed controller P main switch	TA, TC	ZXRD1050P
ZXRD100APQ16	Adjustable controller P main switch	TA, TC	ZXRD100AP

'N main switch' indicates controller for use with N channel main switch element.

'P main switch' indicates controller for use with P channel main switch element.

TA= Tape and Reel quantity of 500

TC= Tape and Reel quantity of 2500

Demonstration Boards

These can be requested through your local Zetex office or representative. These boards can be tailored to your specific needs. If you would like to obtain a demo board then a request form is available to help determine your exact requirement.



Zetex plc.
Fields New Road, Chadderton, Oldham, OL9-8NP, United Kingdom.
Telephone: (44)161 622 4422 (Sales), (44)161 622 4444 (General Enquiries)
Fax: (44)161 622 4420

Zetex GmbH
Streitfeldstraße 19
D-81673 München
Germany
Telefon: (49) 89 45 49 49 0
Fax: (49) 89 45 49 49 49

Zetex Inc.
47 Mall Drive, Unit 4
Commack NY 11725
USA
Telephone: (631) 543-7100
Fax: (631) 864-7630

Zetex (Asia) Ltd.
3701-04 Metroplaza, Tower 1
Hing Fong Road,
Kwai Fong, Hong Kong
Telephone: (852) 26100 611
Fax: (852) 24250 494

These are supported by
agents and distributors in
major countries world-wide
© Zetex plc 2001

<http://www.zetex.com>

This publication is issued to provide outline information only which (unless agreed by the Company in writing) may not be used, applied or reproduced for any purpose or form part of any order or contract or be regarded as a representation relating to the products or services concerned. The Company reserves the right to alter without notice the specification, design, price or conditions of supply of any product or service.