



Cascadable Silicon Bipolar MMIC Amplifier

Technical Data

MSA-0385

Features

- **Cascadable 50 Ω Gain Block**
- **3 dB Bandwidth:**
DC to 2.5 GHz
- **12.0 dB Typical Gain at
1.0 GHz**
- **10.0 dBm Typical $P_{1\text{ dB}}$ at
1.0 GHz**
- **Unconditionally Stable
($k > 1$)**
- **Low Cost Plastic Package**

Description

The MSA-0385 is a high performance silicon bipolar Monolithic Microwave Integrated Circuit (MMIC) housed in a low cost

plastic package. This MMIC is designed for use as a general purpose 50 Ω gain block. Typical applications include narrow and broad band IF and RF amplifiers in commercial and industrial applications.

The MSA-series is fabricated using Agilent's 10 GHz f_T , 25 GHz f_{MAX} , silicon bipolar MMIC process which uses nitride self-alignment, ion implantation, and gold metallization to achieve excellent performance, uniformity and reliability. The use of an external bias resistor for temperature and current stability also allows bias flexibility.

85 Plastic Package

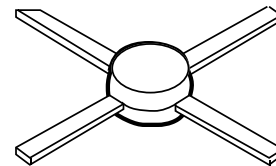

Typical Biasing Configuration

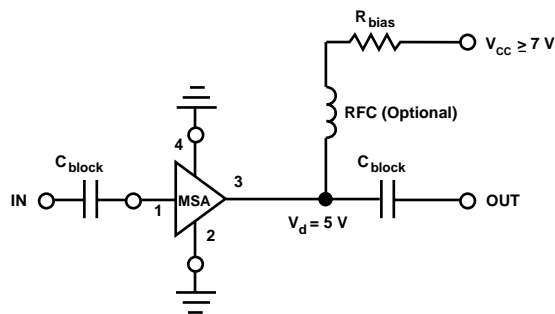

MSA-0385 Absolute Maximum Ratings

Parameter	Absolute Maximum ^[1]
Device Current	70 mA
Power Dissipation ^[2,3]	400 mW
RF Input Power	+13 dBm
Junction Temperature	150°C
Storage Temperature	-65 to 150°C

Thermal Resistance^[2,4]:

$$\theta_{jc} = 105^{\circ}\text{C/W}$$

Notes:

1. Permanent damage may occur if any of these limits are exceeded.
2. $T_{\text{CASE}} = 25^{\circ}\text{C}$.
3. Derate at $9.5 \text{ mW}/^{\circ}\text{C}$ for $T_{\text{C}} > 108^{\circ}\text{C}$.
4. See MEASUREMENTS section "Thermal Resistance" for more information.

Electrical Specifications^[1], $T_{\text{A}} = 25^{\circ}\text{C}$

Symbol	Parameters and Test Conditions: $I_{\text{d}} = 35 \text{ mA}$, $Z_{\text{o}} = 50 \Omega$	Units	Min.	Typ.	Max.
G_{P}	Power Gain ($ S_{21} ^2$) $f = 0.1 \text{ GHz}$ $f = 1.0 \text{ GHz}$	dB	10.0	12.5 12.0	
ΔG_{P}	Gain Flatness $f = 0.1 \text{ to } 1.6 \text{ GHz}$	dB		± 0.7	
$f_{3 \text{ dB}}$	3 dB Bandwidth	GHz		2.5	
VSWR	Input VSWR $f = 0.1 \text{ to } 3.0 \text{ GHz}$			1.5:1	
	Output VSWR $f = 0.1 \text{ to } 3.0 \text{ GHz}$			1.7:1	
NF	50 Ω Noise Figure $f = 1.0 \text{ GHz}$	dB		6.0	
$P_{1 \text{ dB}}$	Output Power at 1 dB Gain Compression $f = 1.0 \text{ GHz}$	dBm		10.0	
IP_3	Third Order Intercept Point $f = 1.0 \text{ GHz}$	dBm		23.0	
t_{D}	Group Delay $f = 1.0 \text{ GHz}$	psec		125	
V_{d}	Device Voltage	V	4.0	5.0	6.0
dV/dT	Device Voltage Temperature Coefficient	$\text{mV}/^{\circ}\text{C}$		-8.0	

Note:

1. The recommended operating current range for this device is 20 to 50 mA. Typical performance as a function of current is on the following page.

MSA-0385 Typical Scattering Parameters ($Z_0 = 50 \Omega$, $T_A = 25^\circ\text{C}$, $I_d = 35 \text{ mA}$)

Freq. GHz	S_{11}		S_{21}			S_{12}			S_{22}	
	Mag	Ang	dB	Mag	Ang	dB	Mag	Ang	Mag	Ang
0.1	.09	178	12.6	4.26	175	-18.1	.124	2	.13	-10
0.2	.09	171	12.5	4.24	170	-18.4	.120	3	.13	-20
0.4	.08	166	12.4	4.17	161	-18.4	.121	6	.14	-41
0.6	.07	160	12.3	4.10	151	-18.0	.126	8	.15	-57
0.8	.07	155	12.1	4.01	142	-17.9	.127	12	.16	-71
1.0	.06	152	11.9	3.92	133	-17.6	.132	12	.18	-84
1.5	.05	-169	11.2	3.63	112	-16.5	.149	18	.21	-112
2.0	.08	-174	10.4	3.29	92	-15.6	.167	19	.23	-136
2.5	.12	-173	9.5	2.98	79	-14.6	.186	22	.25	-150
3.0	.20	178	8.4	2.64	63	-14.1	.198	20	.26	-166
3.5	.25	170	7.5	2.36	47	-13.5	.211	17	.25	-174
4.0	.28	160	6.5	2.12	33	-13.0	.207	13	.24	-180
5.0	.42	134	4.7	1.71	7	-12.2	.224	4	.20	168
6.0	.50	99	2.7	1.37	-18	-12.0	.252	-7	.23	133

A model for this device is available in the DEVICE MODELS section.

Typical Performance, $T_A = 25^\circ\text{C}$

(unless otherwise noted)

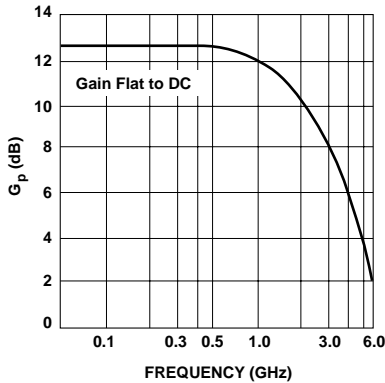

Figure 1. Typical Power Gain vs. Frequency, $T_A = 25^\circ\text{C}$, $I_d = 35 \text{ mA}$.

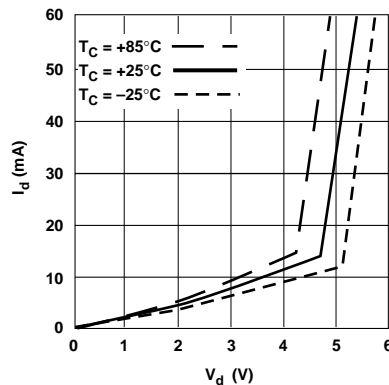

Figure 2. Device Current vs. Voltage.

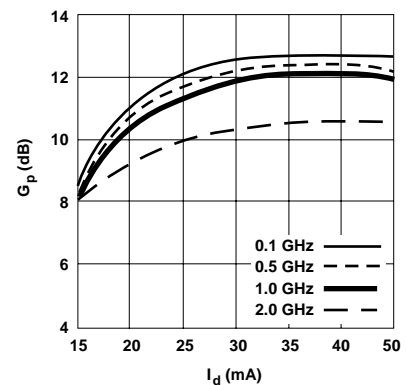

Figure 3. Power Gain vs. Current.

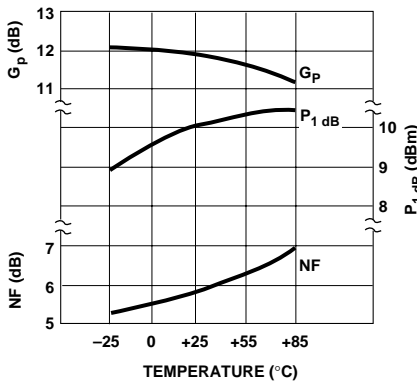

Figure 4. Output Power at 1 dB Gain Compression, NF and Power Gain vs. Case Temperature, $f = 1.0 \text{ GHz}$, $I_d = 35 \text{ mA}$.

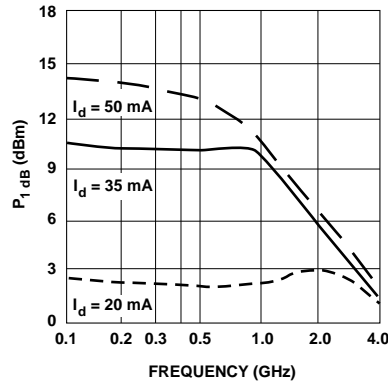

Figure 5. Output Power at 1 dB Gain Compression vs. Frequency.

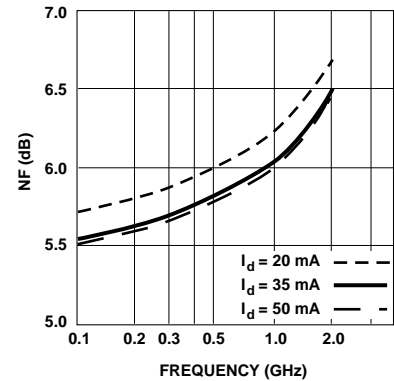

Figure 6. Noise Figure vs. Frequency.



85 Plastic Package Dimensions

