

ASSP Mobile Communication Systems

Piezoelectric SAW BPF (700 to 1000 MHz)

F5CH Series (L2 type)

■ DESCRIPTION

The F5CH series of SAW bandpass filters apply to the frequency range 700 to 1000 MHz.

The SAW filters are fabricated on a lithium tantalate (LiTaO_3) substrate, producing filters with a wide frequency bandwidth, low insertion loss in passband and superior stability due to the high electromechanical coupling coefficient of the material.

The F5CH series filters are housed in a small surface mount package. Moreover, the impedance in the passband is 50 ohms, and so applications require no external matching circuits.

The F5CH series SAW filters are suitable for interstage RF filter in mobile communications systems in the frequency range 700 to 1000 MHz. Standard devices are available for AMPS, ETACS, GSM, EGSM, PDC and so on.

■ FEATURES

- Low insertion loss and high attenuation
- High handling power (0.2 Watt)
- Ultra compact and light package (3.8 mm)
- External matching circuits are not required.
- Surface mount package (SMT)
- Wide variety of standard devices for worldwide mobile communication systems (AMPS, GSM, EGSM, ETACS, PDC800, NTACS, 2 WAY PAGER etc.)

■ PACKAGE

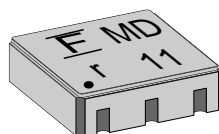

F5CH Series (L2 type)

■ PIN ASSIGNMENT

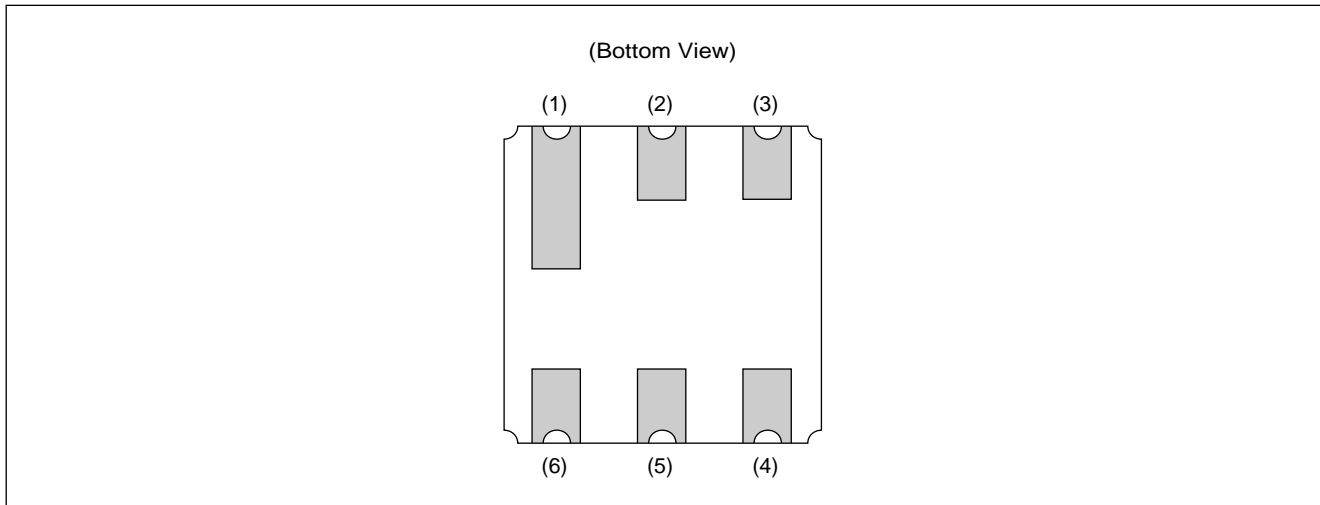

■ PIN DESCRIPTION

Pin No.	Pin name	Description
1	GND	Ground Pin
2	IN	Input Pin
3	GND	Ground Pin
4	GND	Ground Pin
5	OUT	Output Pin
6	GND	Ground Pin

■ ABSOLUTE MAXIMUM RATINGS (See WARNING)

Parameter	Symbol	Rating	Unit
Operating temperature	T_a	-30 to +85	°C
Storage temperature	T_{stg}	-40 to +100	°C
Maximum input power	P_{IN}	200	mW
Frequency range	—	700 to +1000	MHz

WARNING: Permanent device damage may occur if the above **Absolute Maximum Ratings** are exceeded. Functional operation should be restricted to the conditions as detailed in the operational sections of this data sheet. Exposure to absolute maximum rating conditions for extended periods may affect device reliability.

■ RECOMMENDED OPERATING CONDITIONS

Parameter	Symbol	Value	Unit
Operating temperature	T_a	-30 to +85	°C

F5CH Series (L2 type)

■ STANDARD FREQUENCIES

System		Center freq. (MHz)	BW (MHz)	Part Symbol	Part number	Remarks
AMPS/ADC	Tx	836.5	25	AL	FAR-F5CH-836M50-L2AL	
				AW	FAR-F5CH-836M50-L2AW	High Att. type
	Rx	881.5	25	AM	FAR-F5CH-881M50-L2AM	
				AV	FAR-F5CH-881M50-L2AV	High Att. type
ETACS	Tx	888.5	33	CL	FAR-F5CH-888M50-L2CL	
				CW	FAR-F5CH-888M50-L2CW	High Att. type
	Rx	933.5	33	CM	FAR-F5CH-933M50-L2CM	
NTACS	Tx	911.5	27	DL	FAR-F5CH-911M50-L2DL	
	Rx	856.5	27	DM	FAR-F5CH-856M50-L2DM	
GSM/NMT	Tx	902.5	25	EW	FAR-F5CH-902M50-L2EW	High Att. type
	Rx	947.5	25	EM	FAR-F5CH-947M50-L2EM	
				EV	FAR-F5CH-947M50-L2EV	High Att. type
EGSM	Tx	897.5	35	KL	FAR-F5CH-897M50-L2KL	
	Rx	942.5	35	KM	FAR-F5CH-942M50-L2KM	
				KV	FAR-F5CH-942M50-L2KV	High Att. type
PDC800	Tx	950.0	20	FW	FAR-F5CH-950M00-L2FW	High Att. type
	Rx	820.0	20	FM	FAR-F5CH-820M00-L2FM	
				FV	FAR-F5CH-820M00-L2FV	High Att. type
DUAL BAND PDC800	Tx	941.5	33	MD	FAR-F5CH-940M50-L2MD	High Att. type
ISM900	—	915.0	26	JW	FAR-F5CH-915M00-L2JW	High Att. type
N-PCS (2WAY PAGER)	Rx	935.0	12	LA	FAR-F5CH-935M00-L2LA	

F5CH Series (L2 type)

■ ELECTRIC CHARACTERISTICS

1. AMPS/ADC (Tx) Part number: FAR-F5CH-836M50-L2AL

(T_a = -30 to +85°C)

Parameter	Symbol	Condition	Value			Unit	Remarks
			Min.	Typ.	Max.		
Insertion loss	IL	824 to 849 MHz	—	1.6	2.5	dB	
Inband ripple	—	824 to 849 MHz	—	1.0	2.0	dB	
Absolute attenuation	—	869 to 894 MHz	20	25	—	dB	
Inband VSWR	—	824 to 849 MHz	—	1.8	2.0	—	

2. AMPS/ADC (Tx) High Attenuation Type Part number: FAR-F5CH-836M50-L2AW

(T_a = -30 to +85°C)

Parameter	Symbol	Condition	Value			Unit	Remarks
			Min.	Typ.	Max.		
Insertion loss	IL	824 to 849 MHz	—	2.6	3.5	dB	
Inband ripple	—	824 to 849 MHz	—	1.0	2.0	dB	
Absolute attenuation	—	DC to 800 MHz	28	31	—	dB	
	—	869 to 1049 MHz	30	38	—	dB	
	—	1049 to 2000 MHz	25	30	—	dB	
Inband VSWR	—	824 to 849 MHz	—	1.8	2.5	—	

3. AMPS/ADC (Rx) Part number: FAR-F5CH-881M50-L2AM

(T_a = -30 to +85°C)

Parameter	Symbol	Condition	Value			Unit	Remarks
			Min.	Typ.	Max.		
Insertion loss	IL	869 to 894 MHz	—	2.5	3.5	dB	
Inband ripple	—	869 to 894 MHz	—	1.0	2.0	dB	
Absolute attenuation	—	DC to 849 MHz	20	24	—	dB	
	—	914 to 939 MHz	20	30	—	dB	
	—	939 to 1049 MHz	25	30	—	dB	
	—	1049 to 2000 MHz	20	23	—	dB	
Inband VSWR	—	869 to 894 MHz	—	1.8	2.0	—	

F5CH Series (L2 type)

4. AMPS/ADC (Rx) High Attenuation Type Part number: FAR-F5CH-881M50-L2AV

(T_a = -30 to +85°C)

Parameter	Symbol	Condition	Value			Unit	Remarks
			Min.	Typ.	Max.		
Insertion loss	IL	869 to 894 MHz	—	3.0	3.5	dB	
Inband ripple	—	869 to 894 MHz	—	1.0	2.0	dB	
Absolute attenuation	—	DC to 779 MHz	25	33	—	dB	
	—	779 to 849 MHz	35	40	—	dB	
	—	914 to 939 MHz	20	30	—	dB	
	—	939 to 1049 MHz	40	42	—	dB	
	—	1049 to 2000 MHz	25	30	—	dB	
Inband VSWR	—	869 to 894 MHz	—	1.7	2.0	—	

5. ETACS (Tx) Part number: FAR-F5CH-888M50-L2CL

(T_a = -30 to +85°C)

Parameter	Symbol	Condition	Value			Unit	Remarks
			Min.	Typ.	Max.		
Insertion loss	IL	872 to 905 MHz	—	3.0	5.0	dB	
Inband ripple	—	872 to 905 MHz	—	1.5	—	dB	
Absolute attenuation	—	917 to 950 MHz	10	15	—	dB	
Inband VSWR	—	872 to 905 MHz	—	2.0	2.5	—	

6. ETACS (Tx) High Attenuation Type Part number: FAR-F5CH-888M50-L2CW

(T_a = -30 to +85°C)

Parameter	Symbol	Condition	Value			Unit	Remarks
			Min.	Typ.	Max.		
Insertion loss	IL	872 to 905 MHz	—	3.8	5.5	dB	
Inband ripple	—	872 to 905 MHz	—	2.0	—	dB	
Absolute attenuation	—	DC to 850 MHz	30	34	—	dB	
	—	917 to 925 MHz	10	15	—	dB	
	—	925 to 950 MHz	20	30	—	dB	
	—	950 to 1100 MHz	35	45	—	dB	
	—	1100 to 2000 MHz	25	30	—	dB	
Inband VSWR	—	872 to 905 MHz	—	2.0	3.5	—	

F5CH Series (L2 type)

7. ETACS (Rx) Part number: FAR-F5CH-933M50-L2CM

(T_a = -30 to +85°C)

Parameter	Symbol	Condition	Value			Unit	Remarks
			Min.	Typ.	Max.		
Insertion loss	IL	917 to 950 MHz	—	3.8	5.5	dB	
Inband ripple	—	917 to 950 MHz	—	2.0	—	dB	
Absolute attenuation	—	DC to 900 MHz	30	34	—	dB	
	—	900 to 905 MHz	10	15	—	dB	
	—	1007 to 1040 MHz	35	40	—	dB	
	—	1040 to 2000 MHz	25	30	—	dB	
Inband VSWR	—	917 to 950 MHz	—	2.0	2.5	—	

8. NTACS (Tx) Part number: FAR-F5CH-911M50-L2DL

(T_a = -30 to +85°C)

Parameter	Symbol	Condition	Value			Unit	Remarks
			Min.	Typ.	Max.		
Insertion loss	IL	898 to 925 MHz	—	2.6	3.5	dB	
Inband ripple	—	898 to 925 MHz	—	1.0	2.0	dB	
Absolute attenuation	—	843 to 870 MHz	30	32	—	dB	
Inband VSWR	—	898 to 925 MHz	—	1.6	2.0	—	

9. NTACS (Rx) Part number: FAR-F5CH-856M50-L2DM

(T_a = -30 to +85°C)

Parameter	Symbol	Condition	Value			Unit	Remarks
			Min.	Typ.	Max.		
Insertion loss	IL	843 to 870 MHz	—	2.5	3.0	dB	
Inband ripple	—	843 to 870 MHz	—	1.0	2.0	dB	
Absolute attenuation	—	DC to 733 MHz	23	25	—	dB	
	—	733 to 760 MHz	35	37	—	dB	
	—	760 to 815 MHz	25	33	—	dB	
	—	898 to 953 MHz	30	35	—	dB	
	—	953 to 980 MHz	35	40	—	dB	
	—	980 to 1100 MHz	25	35	—	dB	
	—	1100 to 2000 MHz	20	24	—	dB	
Inband VSWR	—	843 to 870 MHz	—	1.8	2.5	—	

F5CH Series (L2 type)

10. GSM/NMT (Tx) High Attenuation Type Part number: FAR-F5CH-902M50-L2EW

(T_a = -30 to +85°C)

Parameter	Symbol	Condition	Value			Unit	Remarks
			Min.	Typ.	Max.		
Insertion loss	IL	890 to 915 MHz	—	2.9	3.5	dB	
Inband ripple	—	890 to 915 MHz	—	1.0	2.0	dB	
Absolute attenuation	—	DC to 845 MHz	32	34	—	dB	
	—	845 to 870 MHz	20	35	—	dB	
	—	935 to 980 MHz	20	35	—	dB	
	—	980 to 1200 MHz	35	40	—	dB	
	—	1200 to 2000 MHz	25	30	—	dB	
Inband VSWR	—	890 to 915 MHz	—	1.6	2.0	—	

11. GSM/NMT (Rx) Part number: FAR-F5CH-947M50-L2EM

(T_a = -30 to +85°C)

Parameter	Symbol	Condition	Value			Unit	Remarks
			Min.	Typ.	Max.		
Insertion loss	IL	935 to 960 MHz	—	2.5	3.5	dB	
Inband ripple	—	935 to 960 MHz	—	1.0	2.0	dB	
Absolute attenuation	—	DC to 800 MHz	20	25	—	dB	
	—	890 to 915 MHz	20	35	—	dB	
	—	980 to 1025 MHz	15	28	—	dB	
	—	1025 to 1105 MHz	35	38	—	dB	
	—	1105 to 1600 MHz	25	29	—	dB	
	—	1600 to 2000 MHz	20	26	—	dB	
Inband VSWR	—	935 to 960 MHz	—	1.7	2.5	—	

F5CH Series (L2 type)

12. GSM/NMT (Rx) HIGH ATTENUATION TYPE Part number: FAR-F5CH-947M50-L2EV

(T_a = -30 to +85°C)

Parameter	Symbol	Condition	Value			Unit	Remarks
			Min.	Typ.	Max.		
Insertion loss	IL	935 to 960 MHz	—	2.8	3.5	dB	
Inband ripple	—	935 to 960 MHz	—	1.0	2.0	dB	
Absolute attenuation	—	DC to 770 MHz	32	34	—	dB	
	—	770 to 855 MHz	35	38	—	dB	
	—	855 to 871 MHz	40	43	—	dB	
	—	890 to 915 MHz	20	30	—	dB	
	—	980 to 1025 MHz	15	25	—	dB	
	—	1025 to 1077 MHz	40	46	—	dB	
	—	1077 to 1105 MHz	43.5	47	—	dB	
	—	1105 to 2000 MHz	25	30	—	dB	
Inband VSWR	—	935 to 960 MHz	—	1.6	2.0	—	

13. EGSM (Tx) Part number: FAR-F5CH-897M50-L2KL

(T_a = -20 to +80°C)

Parameter	Symbol	Condition	Value			Unit	Remarks
			Min.	Typ.	Max.		
Insertion loss	IL	880 to 915 MHz	—	2.4	4.0	dB	
Inband ripple	—	880 to 915 MHz	—	1.0	2.0	dB	
Absolute attenuation	—	DC to 845 MHz	20	21	—	dB	
	—	925 to 935 MHz	5	—	—	dB	-20 to +25°C
			8	10	—	dB	+25 to +80°C
—	935 to 980 MHz	20	25	—	dB		
Inband VSWR	—	880 to 915 MHz	—	1.9	2.5	—	

F5CH Series (L2 type)

14. EGSM (Rx)

Part number: FAR-F5CH-942M50-L2KM

(T_a = -20 to +80°C)

Parameter	Symbol	Condition	Value			Unit	Remarks
			Min.	Typ.	Max.		
Insertion loss	IL	925 to 960 MHz	—	3.2	4.0	dB	
Inband ripple	—	925 to 960 MHz	—	1.0	2.0	dB	
Absolute attenuation	—	DC to 619 MHz	25	26	—	dB	
		619 to 905 MHz	26	27	—	dB	
	—	905 to 915 MHz	10	20	—	dB	-20 to +25°C
			7	—	—	dB	+25 to +80°C
	—	980 to 1200 MHz	20	30	—	dB	
—	1200 to 2000 MHz	25	27	—	dB		
Inband VSWR	—	925 to 960 MHz	—	2.0	2.5	—	

15. EGSM (Rx) High Attenuation Type

Part number: FAR-F5CH-942M50-L2KV

(T_a = -20 to +80°C)

Parameter	Symbol	Condition	Value			Unit	Remarks
			Min.	Typ.	Max.		
Insertion loss	IL	925 to 960 MHz	—	3.0	5.0	dB	
Inband ripple	—	925 to 960 MHz	—	1.5	2.5	dB	
Absolute attenuation	—	DC to 619 MHz	30	34	—	dB	
		619 to 905 MHz	30	35	—	dB	
	—	905 to 915 MHz	8	10	—	dB	-20 to +25°C
			6	—	—	dB	+25 to +80°C
	—	980 to 1200 MHz	20	30	—	dB	
—	1200 to 2000 MHz	30	31	—	dB		
Inband VSWR	—	925 to 960 MHz	—	2.4	2.7	—	

F5CH Series (L2 type)

16. PDC800 (Tx) High Attenuation Type Part number: FAR-F5CH-950M00-L2FW

(T_a = -30 to +85°C)

Parameter	Symbol	Condition	Value			Unit	Remarks
			Min.	Typ.	Max.		
Insertion loss	IL	940 to 960 MHz	—	2.8	3.5	dB	
Inband ripple	—	940 to 960 MHz	—	1.0	2.0	dB	
Absolute attenuation	—	DC to 680 MHz	30	34	—	dB	
	—	680 to 696 MHz	33	36	—	dB	
	—	810 to 830 MHz	40	44	—	dB	
	—	1015 to 1106 MHz	40	45	—	dB	
	—	1106 to 2000 MHz	30	34	—	dB	
Inband VSWR	—	940 to 960 MHz	—	1.6	2.0	—	

17. PDC800 (Rx) Part number: FAR-F5CH-820M00-L2FM

(T_a = -30 to +85°C)

Parameter	Symbol	Condition	Value			Unit	Remarks
			Min.	Typ.	Max.		
Insertion loss	IL	810 to 830 MHz	—	1.8	2.5	dB	
Inband ripple	—	810 to 830 MHz	—	1.0	1.5	dB	
Absolute attenuation	—	DC to 680 MHz	20	24	—	dB	
	—	680 to 700 MHz	25	29	—	dB	
	—	875 to 940 MHz	25	30	—	dB	
	—	940 to 1070 MHz	30	32	—	dB	
	—	1070 to 1090 MHz	35	37	—	dB	
	—	1090 to 2000 MHz	20	24	—	dB	
Inband VSWR	—	810 to 830 MHz	—	1.8	2.0	—	

F5CH Series (L2 type)

18. PDC800 (Rx) High Attenuation Type Part number: FAR-F5CH-820M00-L2FV

(T_a = -30 to +85°C)

Parameter	Symbol	Condition	Value			Unit	Remarks
			Min.	Typ.	Max.		
Insertion loss	IL	810 to 830 MHz	—	3.0	3.5	dB	
Inband ripple	—	810 to 830 MHz	—	1.5	2.0	dB	
Absolute attenuation	—	DC to 130 MHz	35	40	—	dB	
	—	130 to 760 MHz	30	33	—	dB	
	—	855 to 875 MHz	25	35	—	dB	
	—	875 to 920 MHz	40	42	—	dB	
	—	920 to 1090 MHz	35	40	—	dB	
—	1090 to 2000 MHz	25	30	—	dB		
Inband VSWR	—	810 to 830 MHz	—	2.0	2.5	—	

19. Dual Band PDC800 (Tx) BW; 33 MHz Part number: FAR-F5CH-940M50-L2MD

(T_a = -30 to +85°C)

Parameter	Symbol	Condition	Value			Unit	Remarks
			Min.	Typ.	Max.		
Insertion loss	IL	925 to 958 MHz	—	2.7	3.5	dB	
Inband ripple	—	925 to 958 MHz	—	1.2	2.0	dB	
Absolute attenuation	—	DC to 775 MHz	23	26	—	dB	
	—	775 to 885 MHz	30	33	—	dB	
	—	1000 to 1033 MHz	30	38	—	dB	
	—	1075 to 1108 MHz	35	40	—	dB	
	—	1150 to 1183 MHz	35	42	—	dB	
	—	1225 to 1258 MHz	32	35	—	dB	
—	1258 to 2000 MHz	20	25	—	dB		
Inband VSWR	—	925 to 958 MHz	—	2.1	2.5	—	

F5CH Series (L2 type)

20. ISM900 High Attenuation Type Part number: FAR-F5CH-915M00-L2JW

(T_a = -30 to +85°C)

Parameter	Symbol	Condition	Value			Unit	Remarks
			Min.	Typ.	Max.		
Insertion loss	IL	902 to 928 MHz	—	3.0	3.5	dB	
Inband ripple	—	902 to 928 MHz	—	1.5	2.0	dB	
Absolute attenuation	—	DC to 800 MHz	25	27	—	dB	
	—	800 to 880 MHz	20	30	—	dB	
	—	950 to 1080 MHz	30	40	—	dB	
	—	1080 to 2000 MHz	20	24	—	dB	
Inband VSWR	—	902 to 928 MHz	—	2.0	2.5	—	

21. N-PCS (Rx) 2 Way Pager Part number: FAR-F5CH-935M00-L2LA

(T_a = -10 to +50°C)

Parameter	Symbol	Condition	Value			Unit	Remarks
			Min.	Typ.	Max.		
Insertion loss	IL	929 to 941 MHz	—	2.3	3.0	dB	
Inband ripple	—	929 to 941 MHz	—	0.5	1.0	dB	
Absolute attenuation	—	839 to 851 MHz	40	43	—	dB	
	—	1019 to 1031 MHz	40	44	—	dB	
Inband VSWR	—	929 to 941 MHz	—	1.3	2.5	—	

F5CH Series (L2 type)

TYPICAL CHARACTERISTICS (STANDARD VERSION)

1. AMPS/ADC System (Tx) Part number: FAR-F5CH-836M50-L2AL

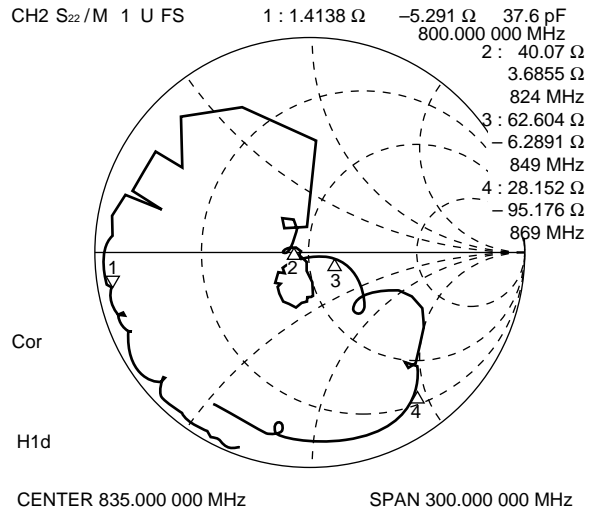
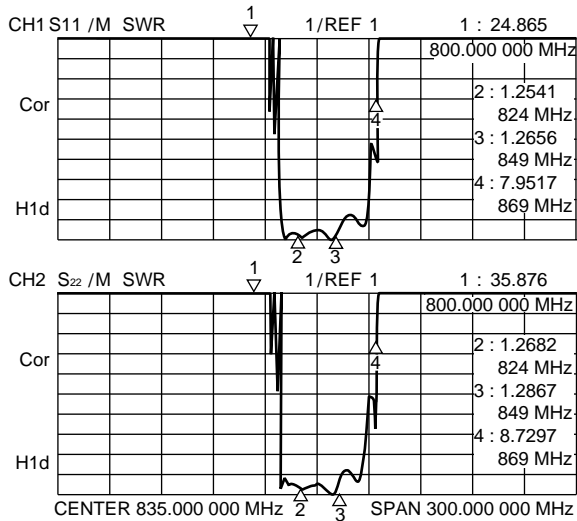
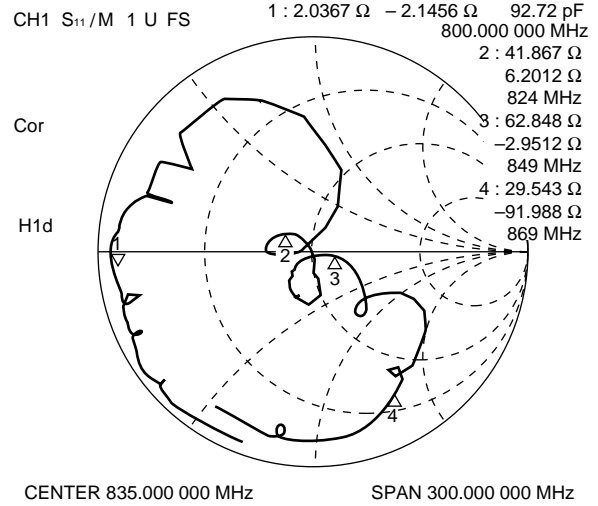
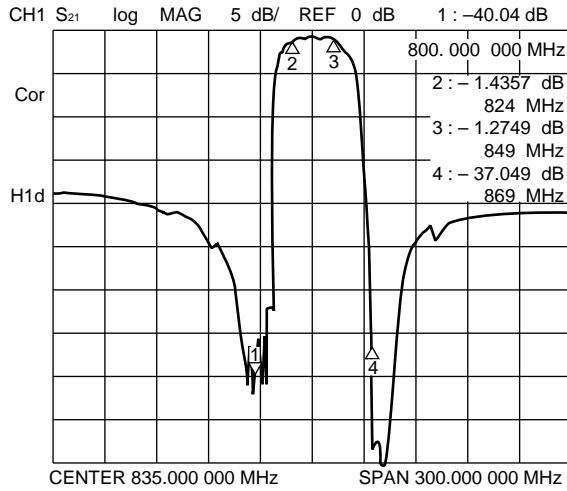

F5CH Series (L2 type)

2. AMPS/ADC System (Tx) High Attenuation type Part number: FAR-F5CH-836M50-L2AW

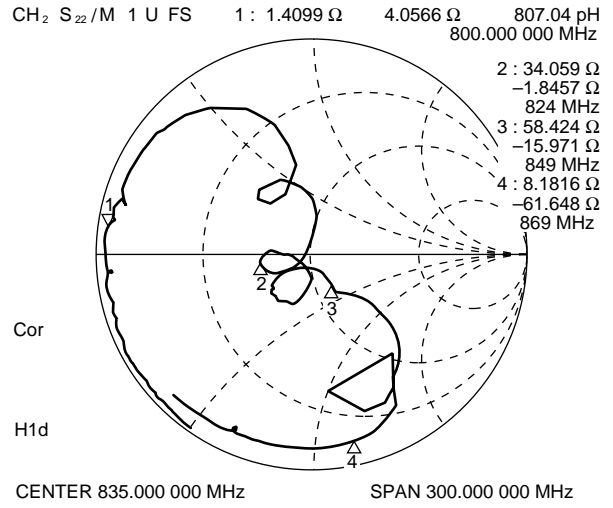
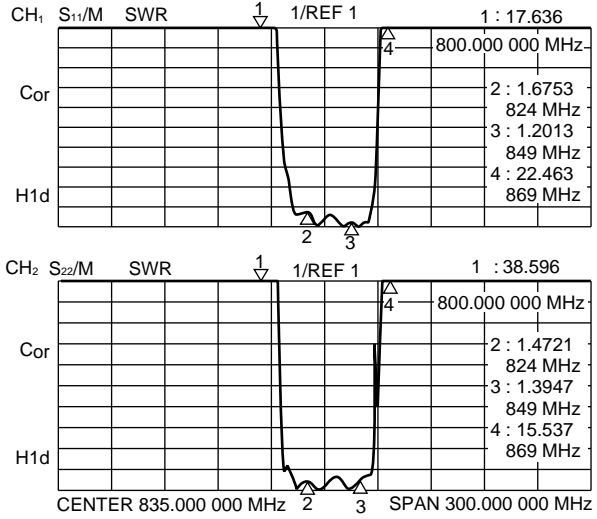
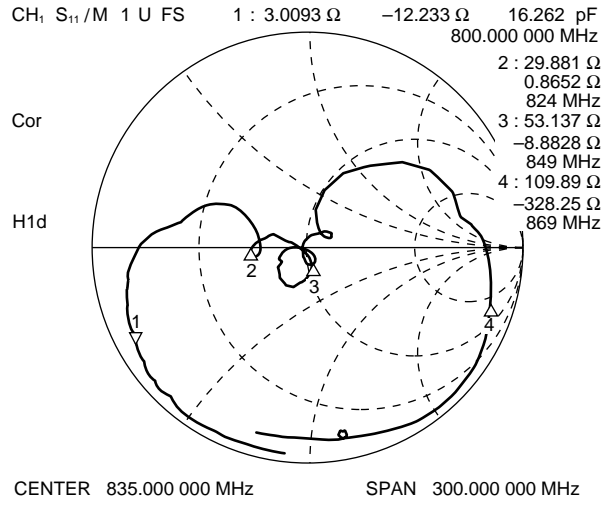
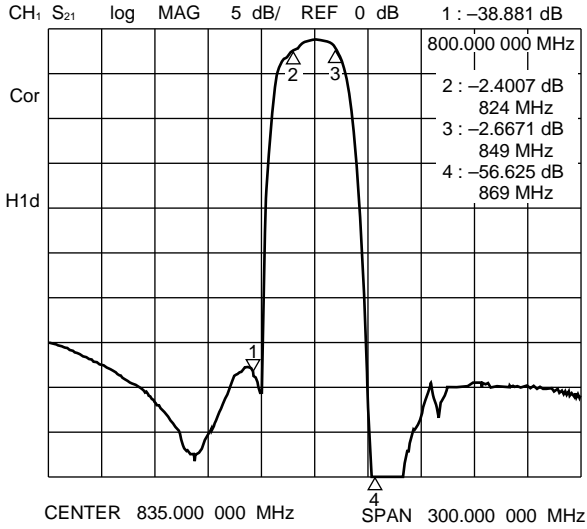

F5CH Series (L2 type)

3. AMPS/ADC System (Rx) Part number: FAR-F5CH-881M50-L2AM

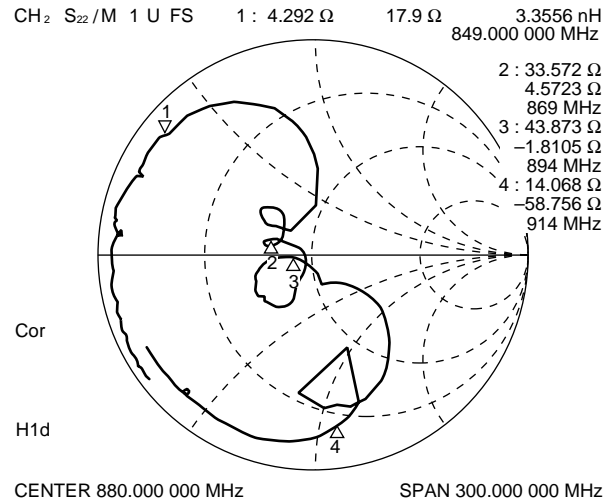
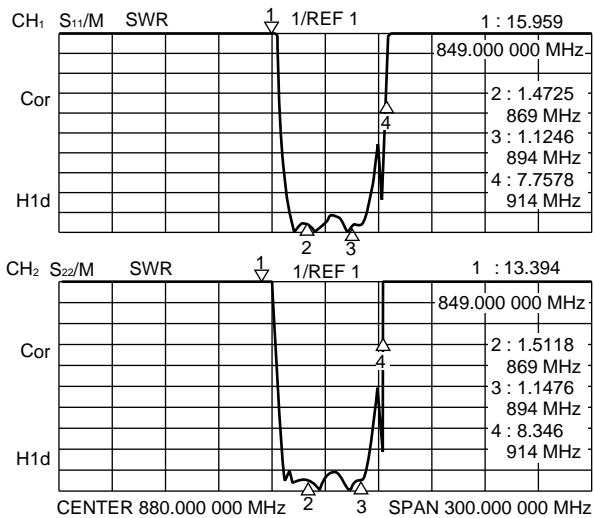
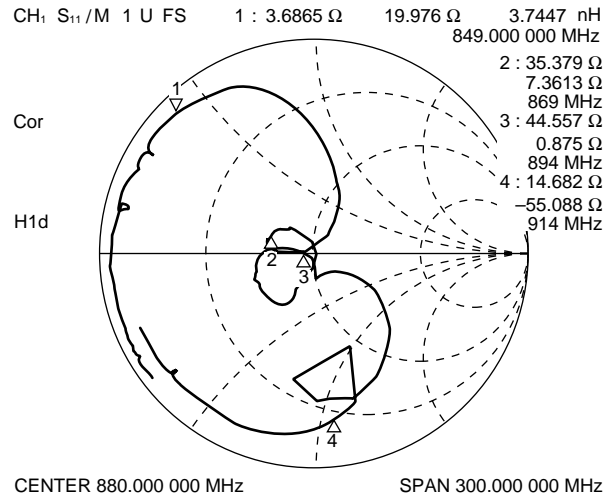
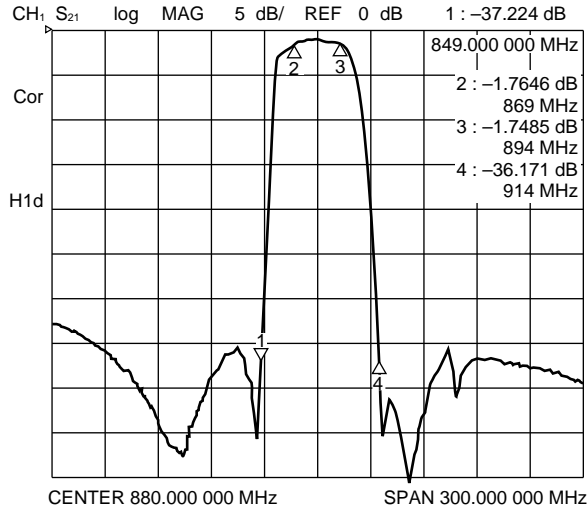

F5CH Series (L2 type)

4. AMPS/ADC System (Rx) High Attenuation type Part number: FAR-F5CH-881M50-L2AV

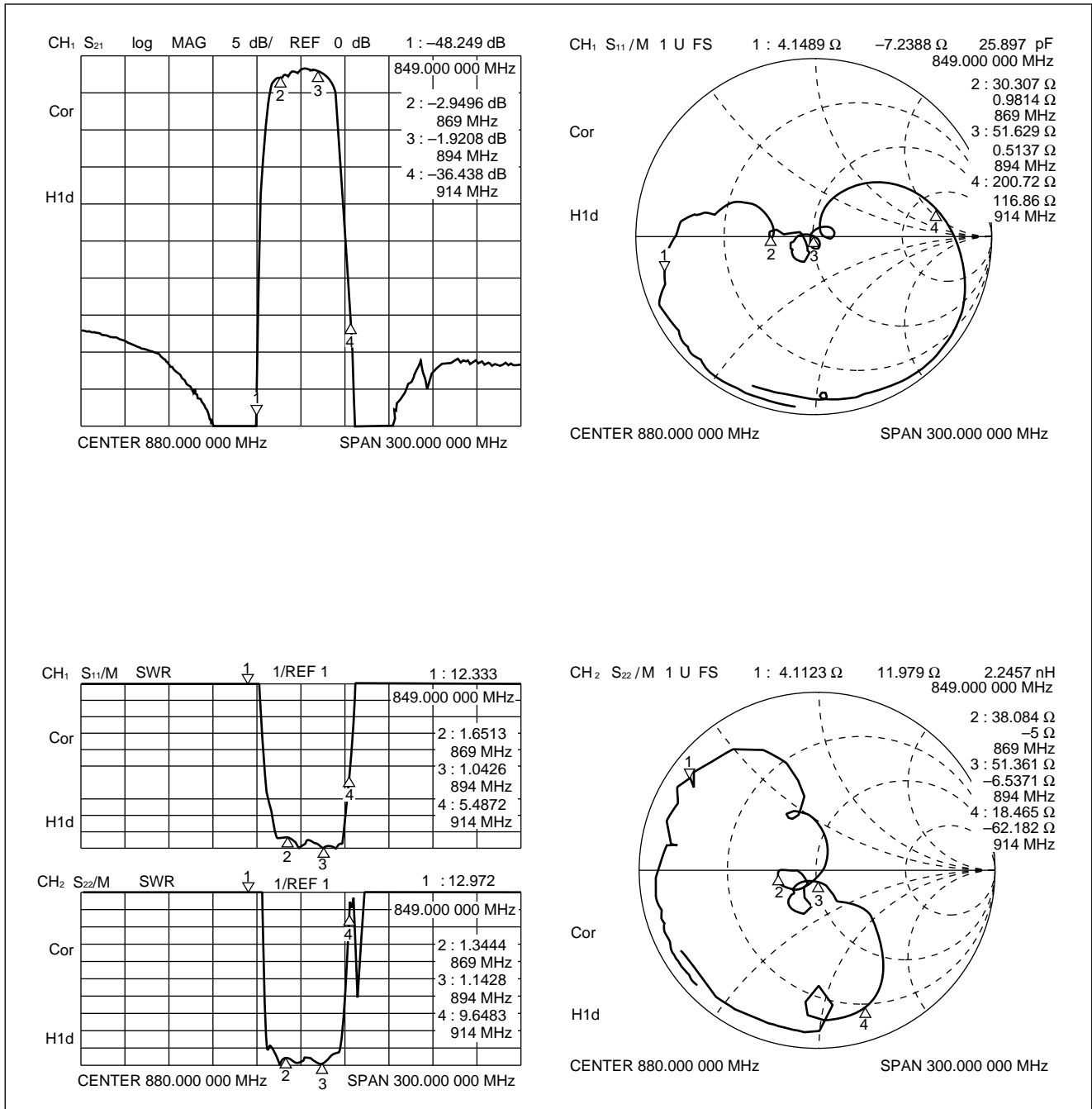

F5CH Series (L2 type)

5. ETACS System (Tx) Part number: FAR-F5CH-888M50-L2CL

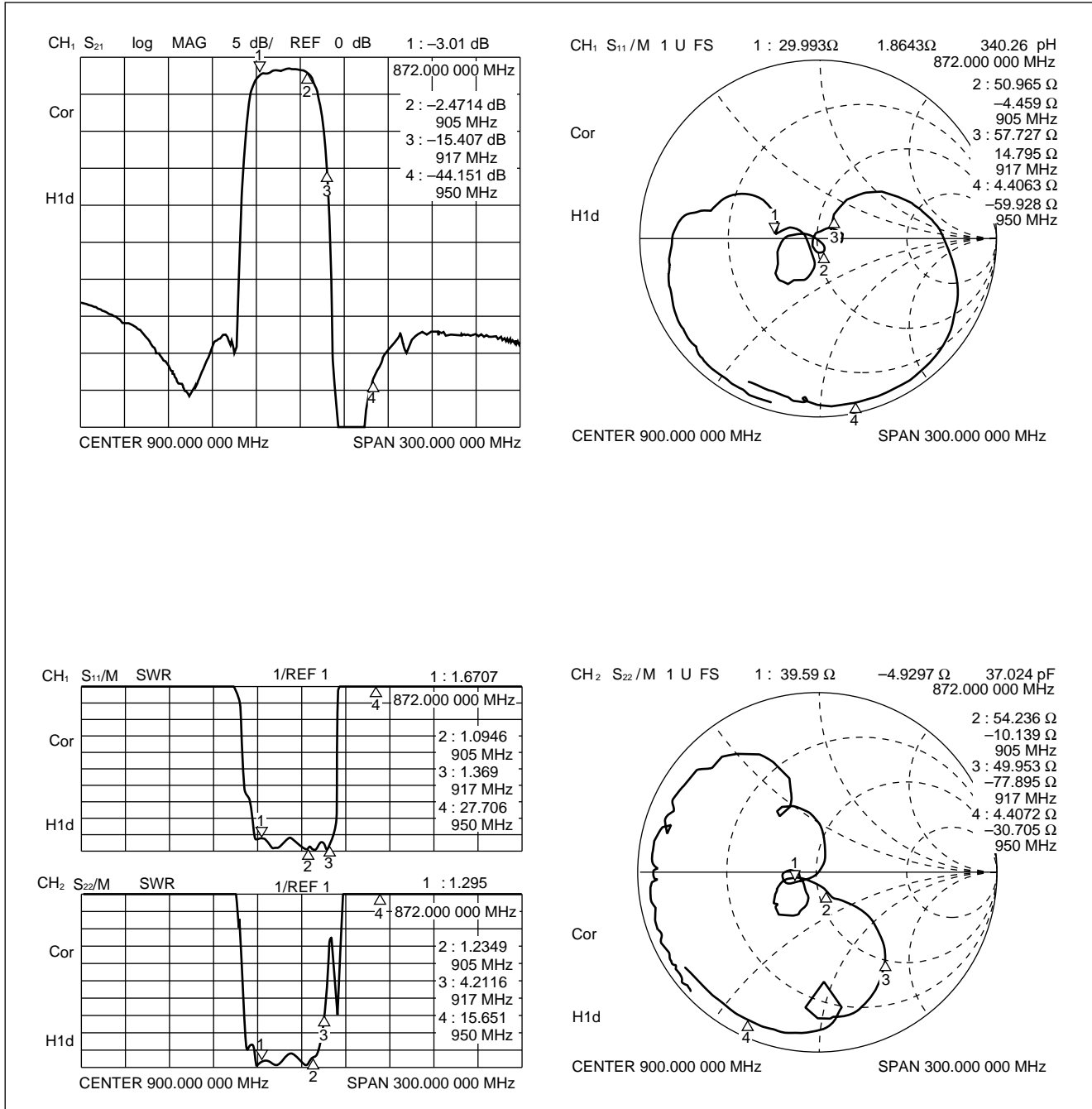

F5CH Series (L2 type)

6. ETACS System (Tx) High Attenuation type Part number: FAR-F5CH-888M50-L2CW

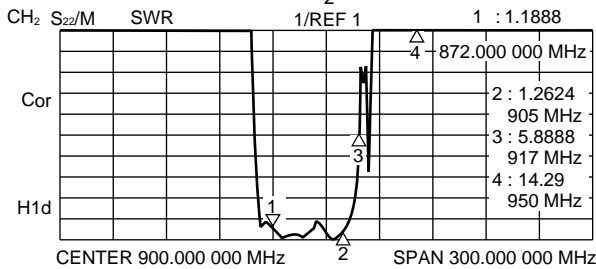
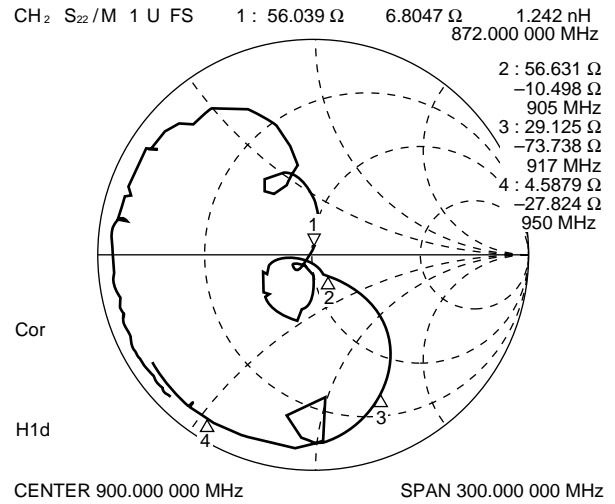
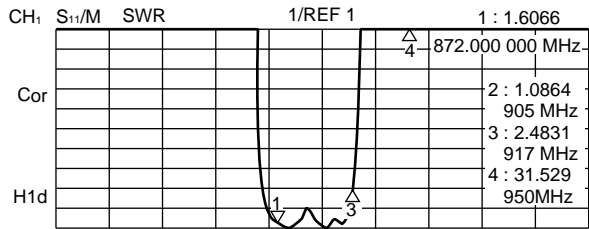
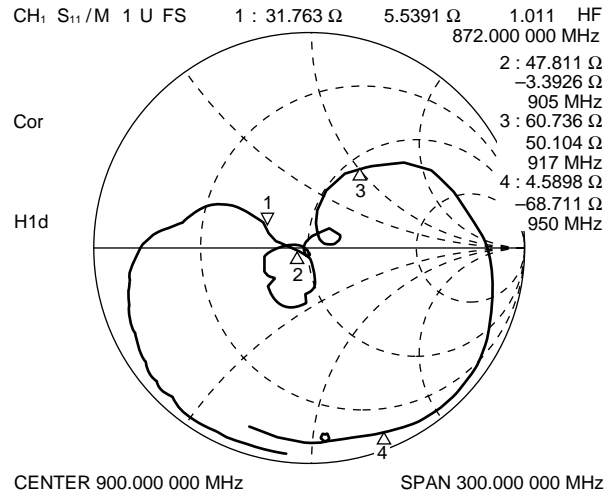
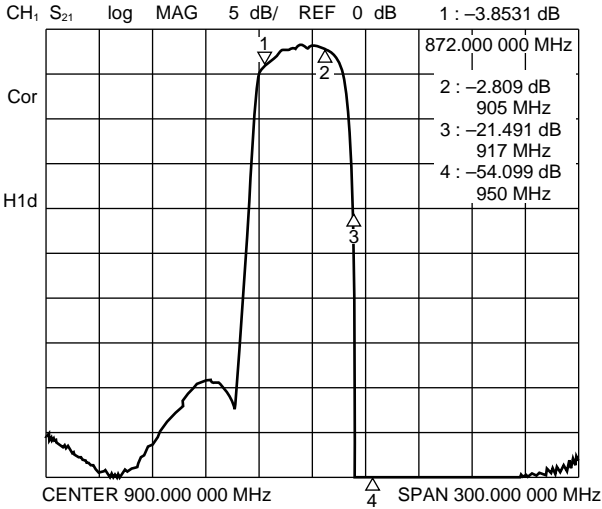

F5CH Series (L2 type)

7. ETACS System (Rx) Part number: FAR-F5CH-933M50-L2CM

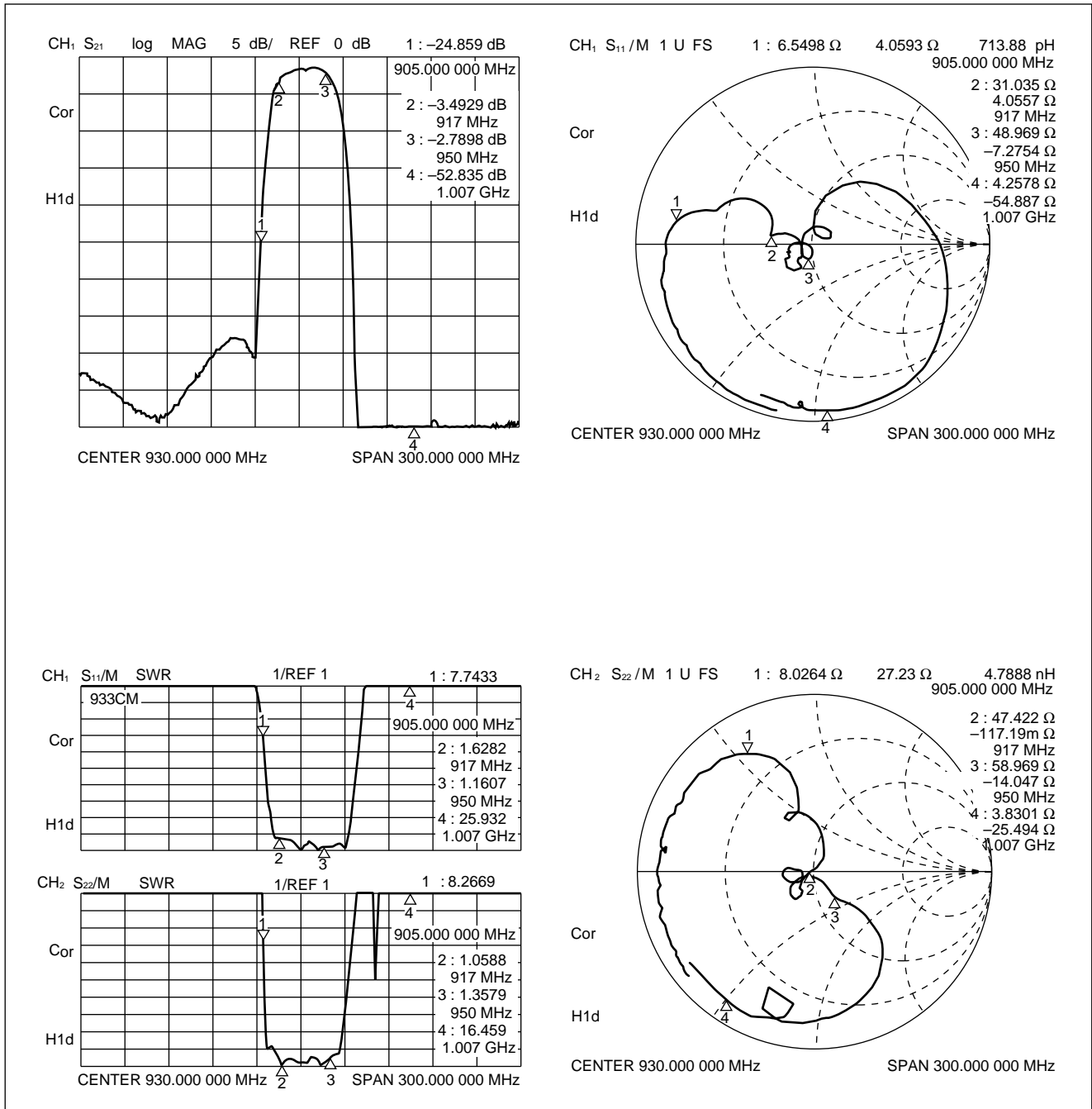

F5CH Series (L2 type)

8. NTACS System (Tx) Part number: FAR-F5CH-911M50-L2DL

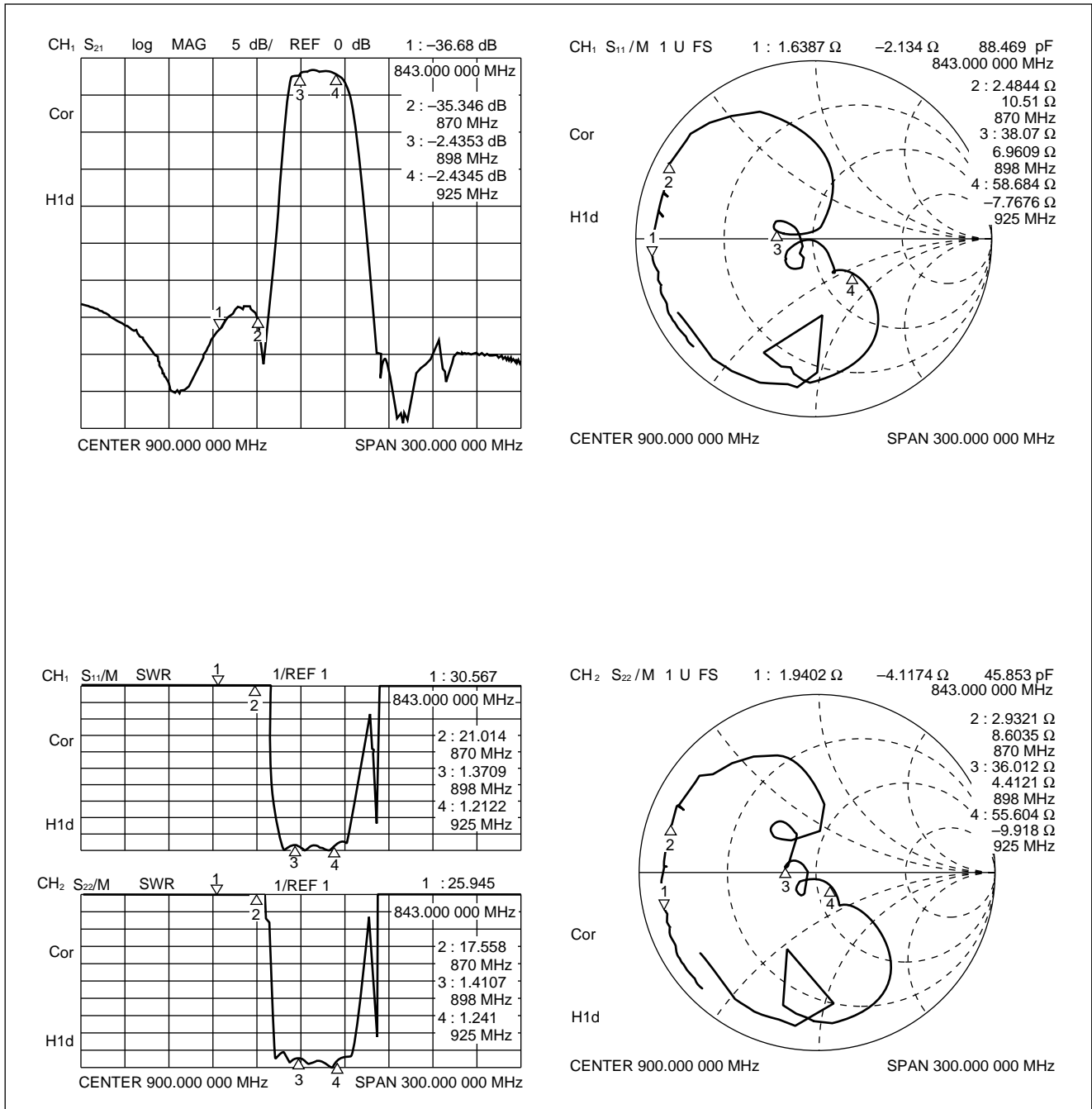

F5CH Series (L2 type)

9. NTACS System (Rx) Part number: FAR-F5CH-856M50-L2DM

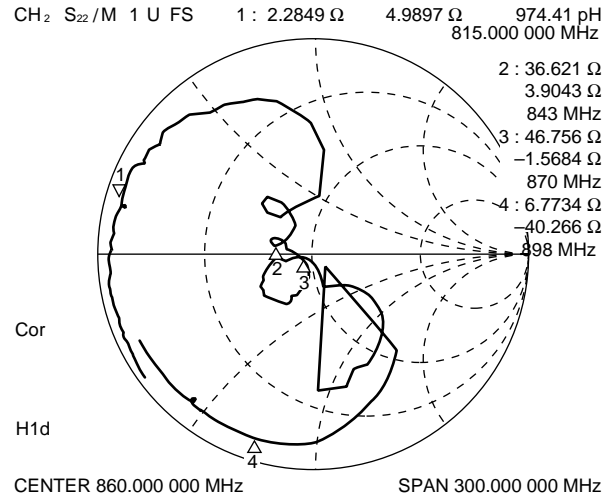
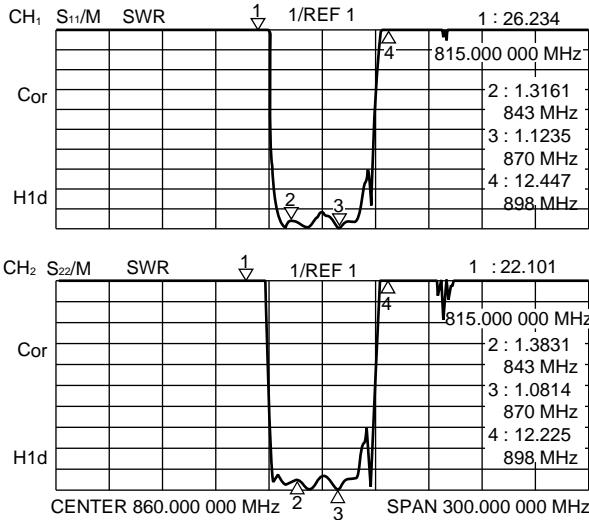
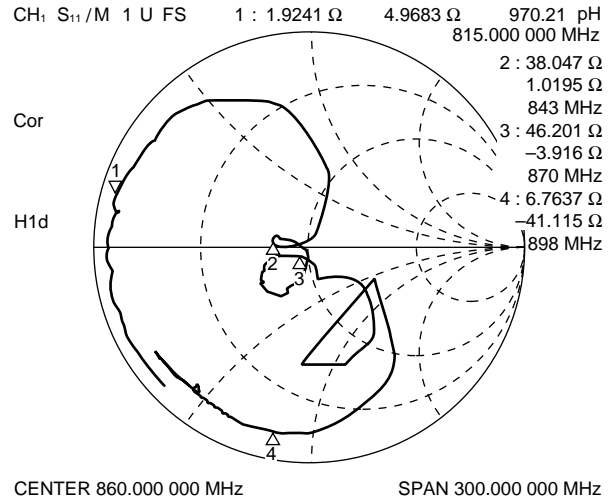
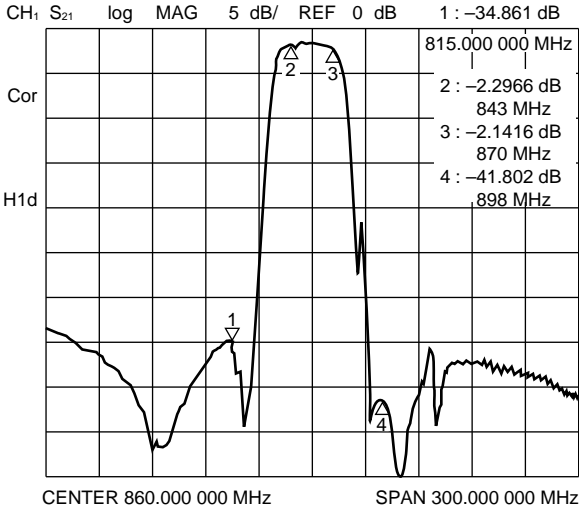

F5CH Series (L2 type)

10. NMT/GSM System (Tx) High Attenuation type Part number: FAR-F5CH-902M50-L2EW

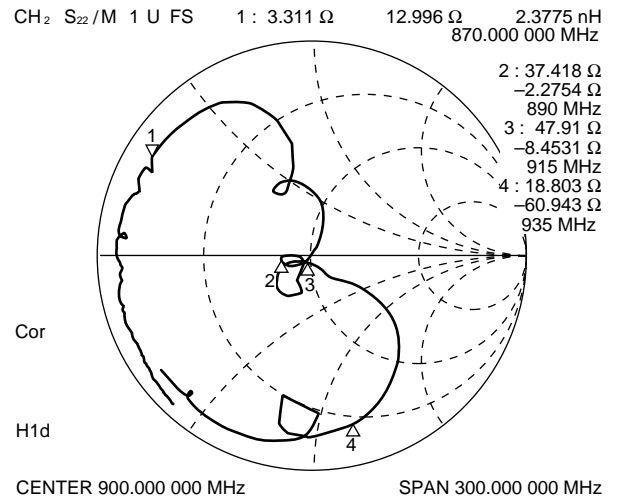
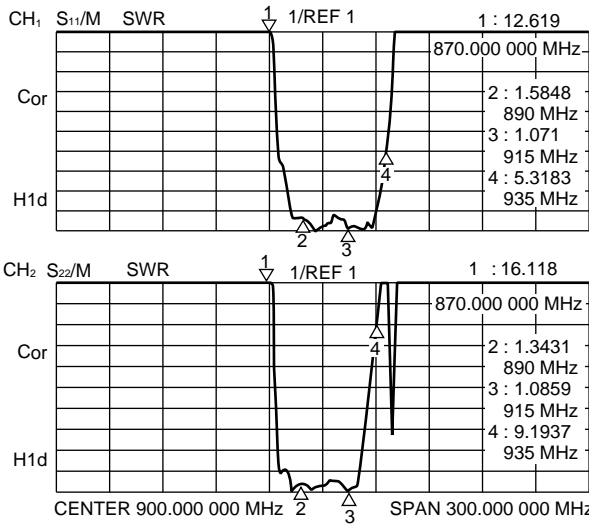
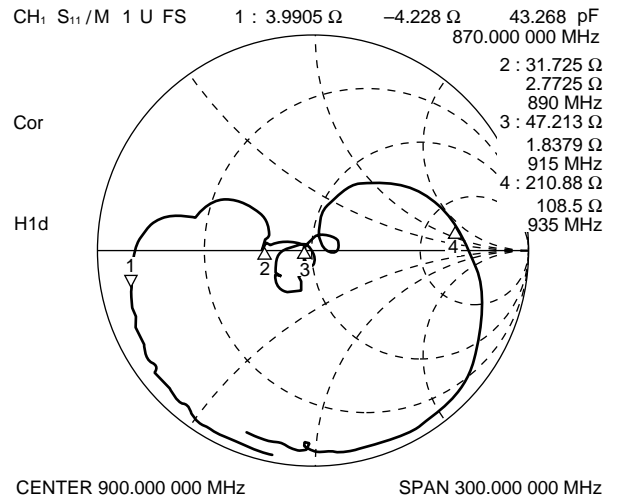
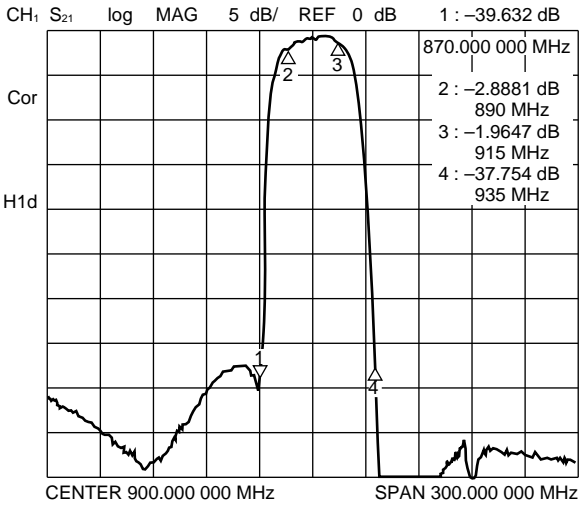

F5CH Series (L2 type)

11. HMT/GSM System (Rx) Part number: FAR-F5CH-947M50-L2EM

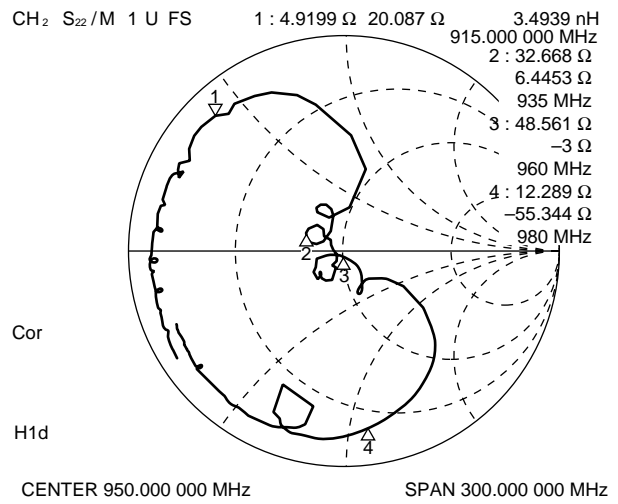
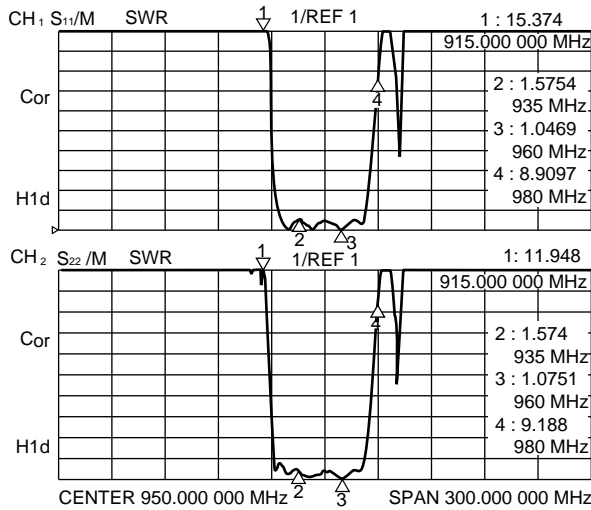
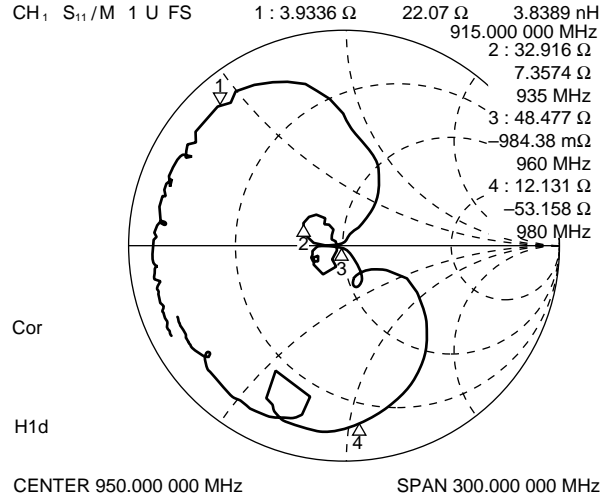
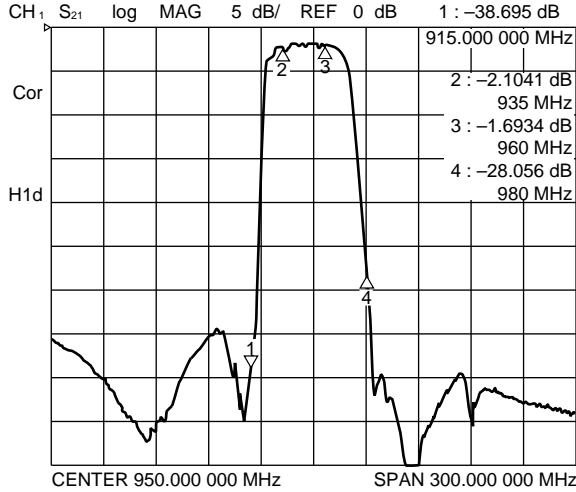

F5CH Series (L2 type)

12. NMT/GSM System (Rx) High Attenuation type Part number: FAR-F5CH-947M50-L2EV

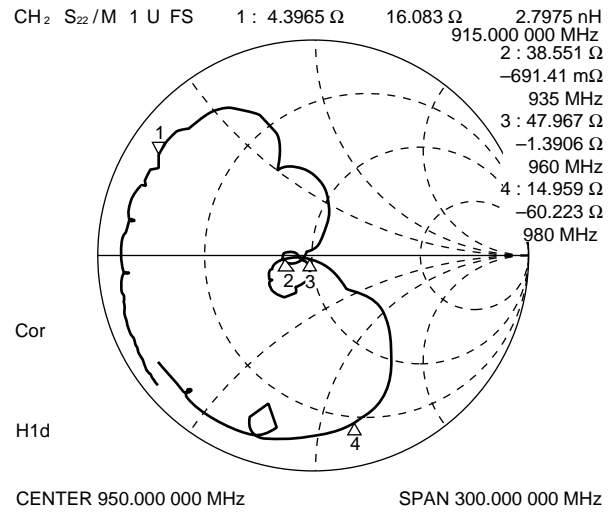
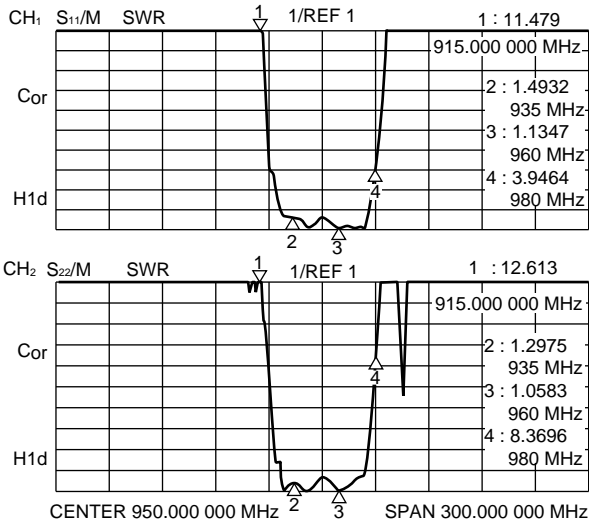
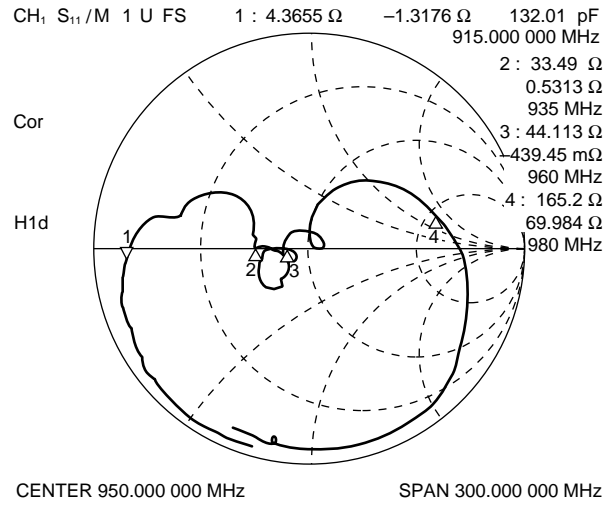
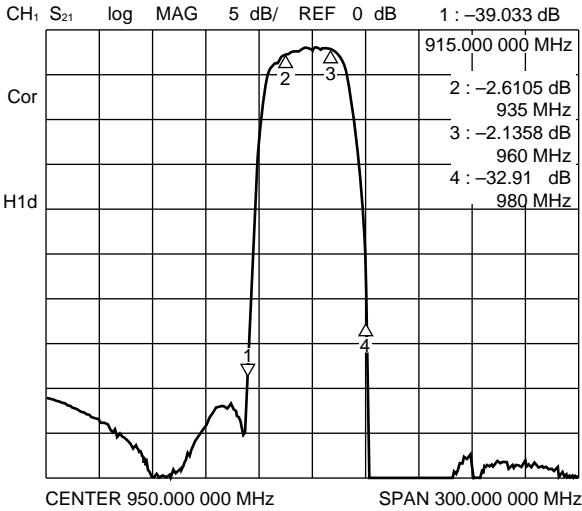

F5CH Series (L2 type)

13. EGSM System (Tx) Part number: FAR-F5CH-897M50-L2KL

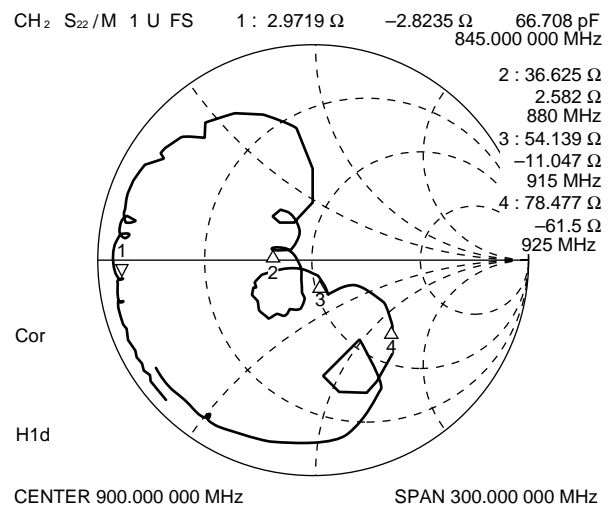
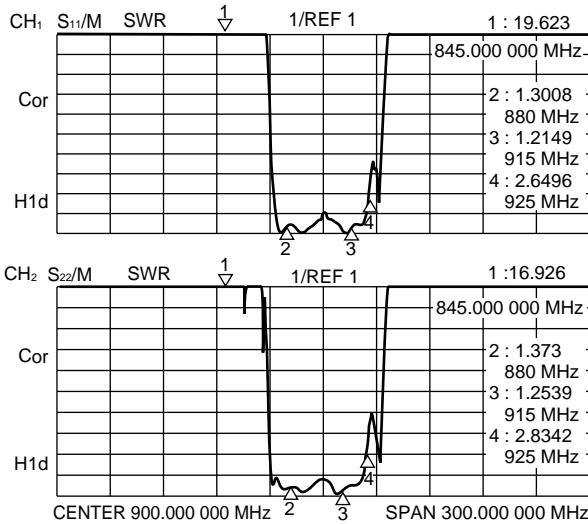
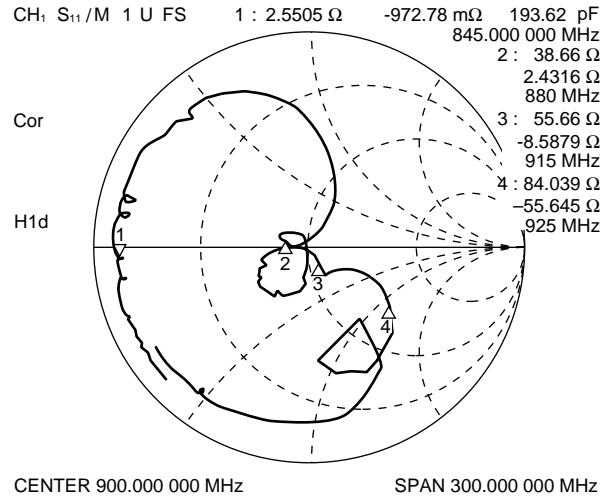
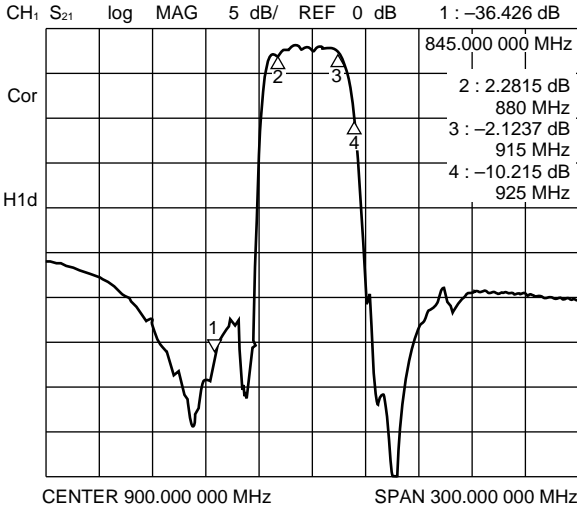

F5CH Series (L2 type)

14. EGSM System (Rx)

Part number: FAR-F5CH-942M50-L2KM

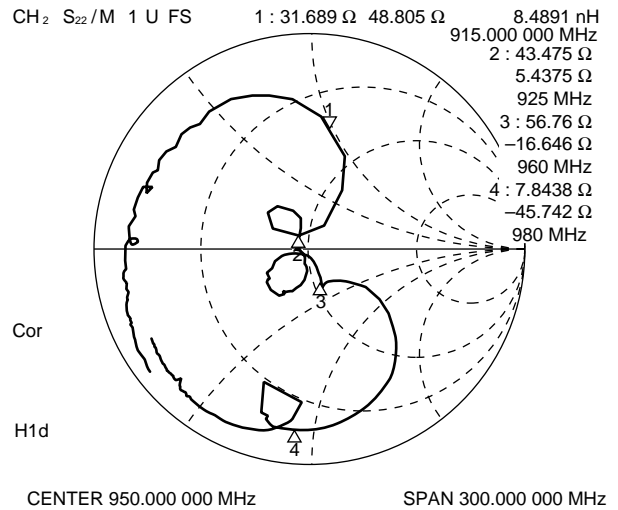
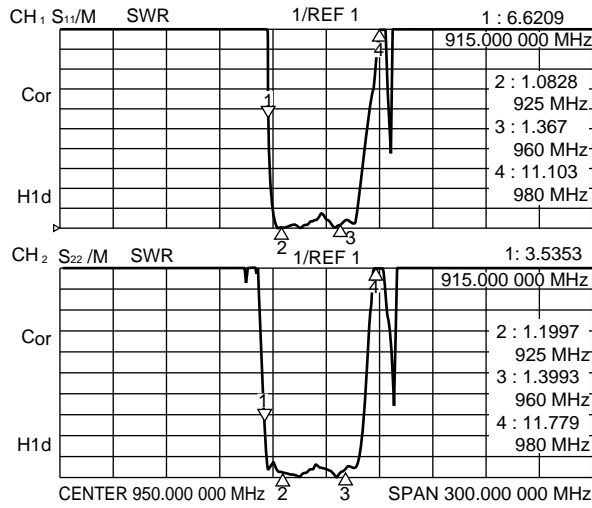
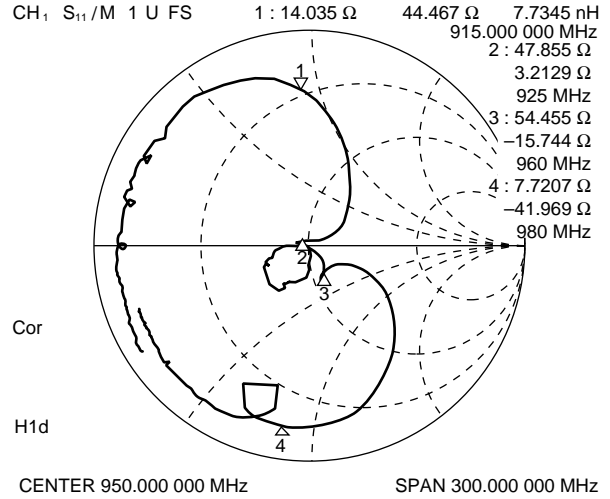
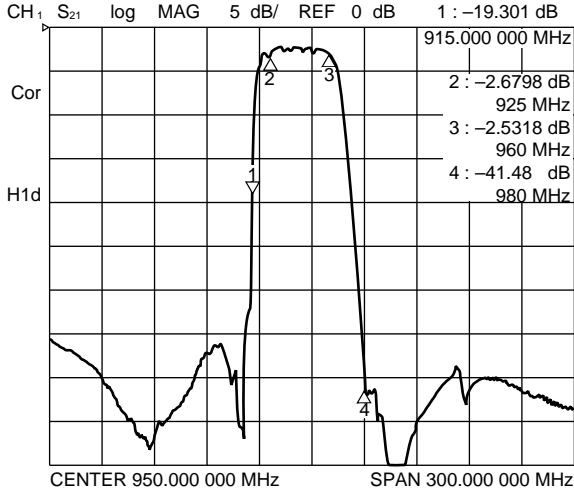

F5CH Series (L2 type)

15. EGSM System (Rx) High Attenuation type Part number: FAR-F5CH-942M50-L2KV

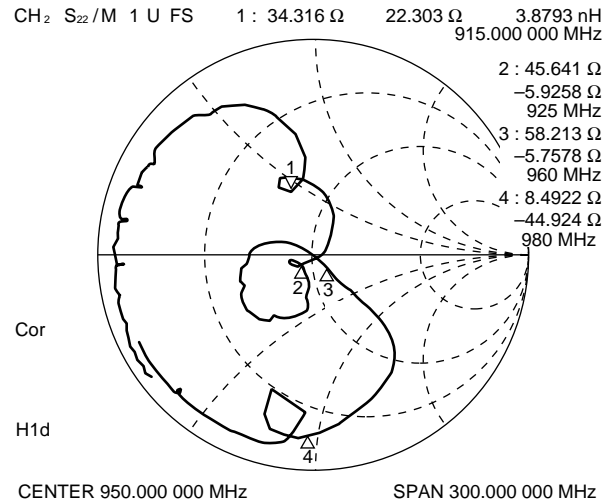
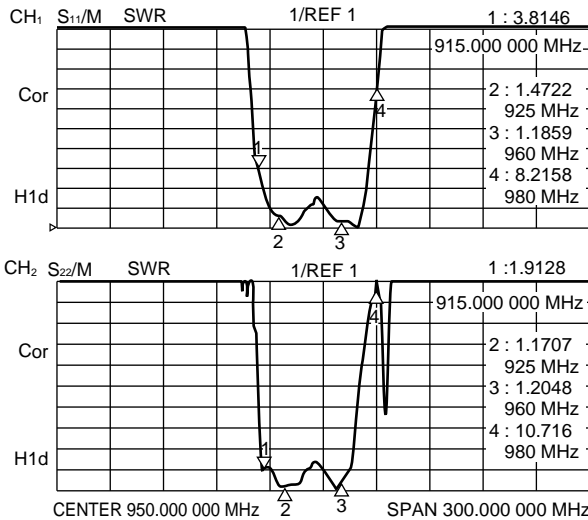
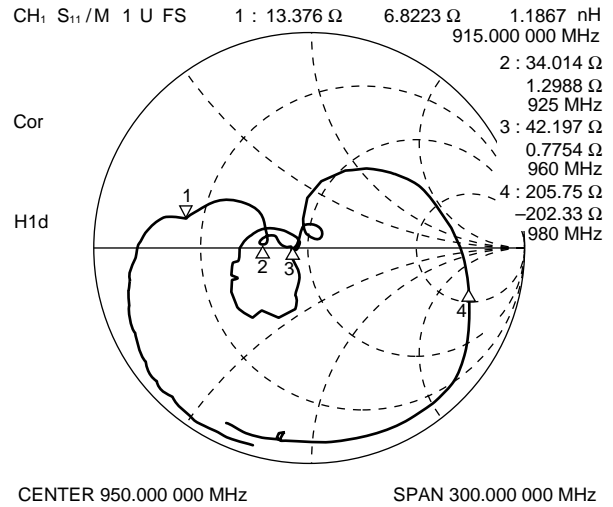
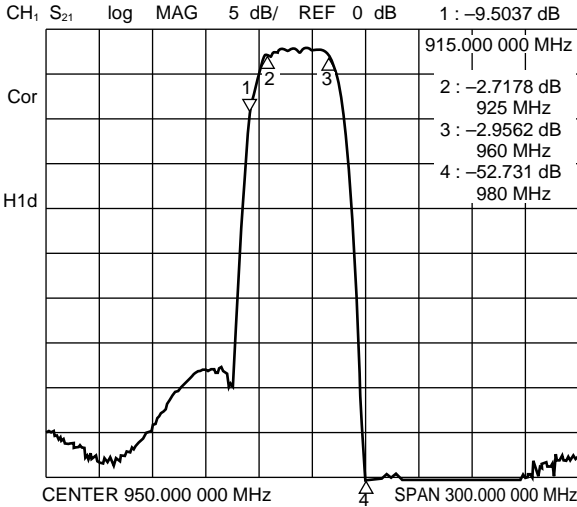

F5CH Series (L2 type)

16. PDC800 System (Tx) High Attenuation Type Part number: FAR-F5CH-950M00-L2FW

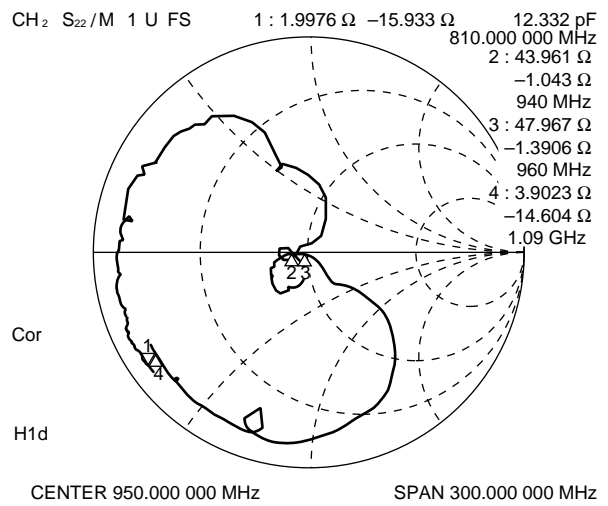
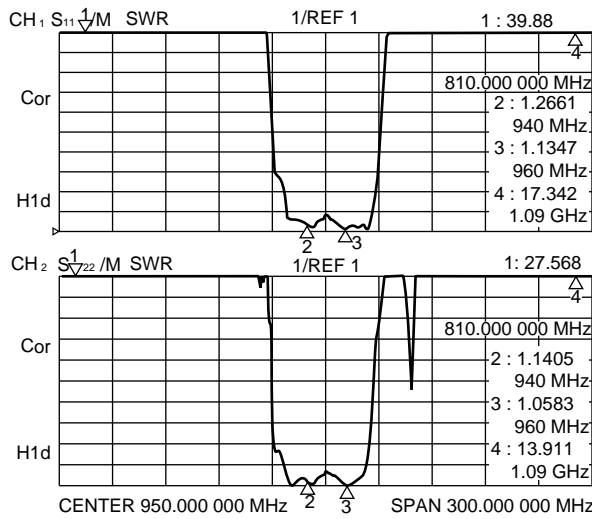
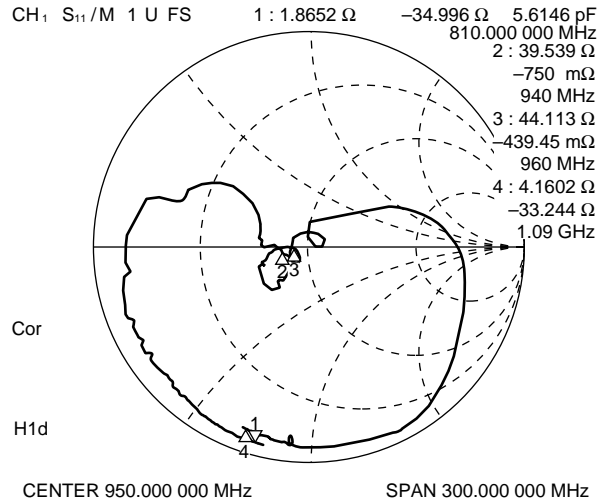
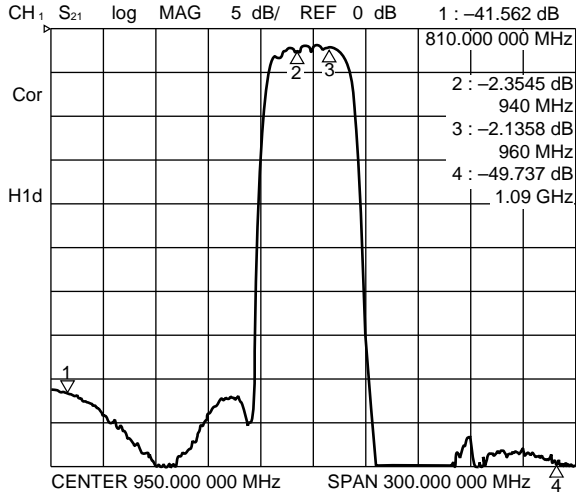

F5CH Series (L2 type)

17. PDC800 System (Rx) Part number: FAR-F5CH-820M00-L2FM

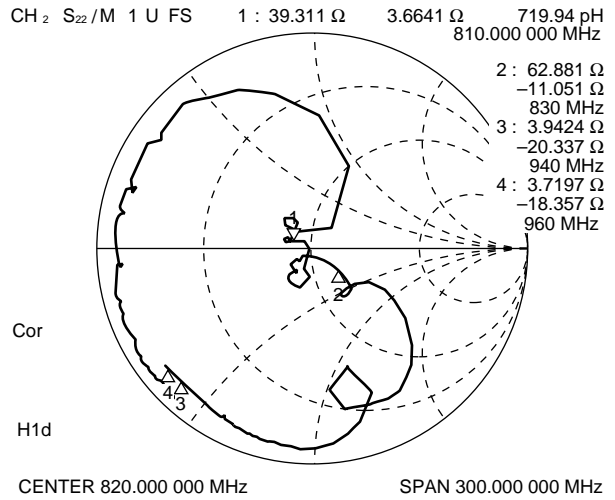
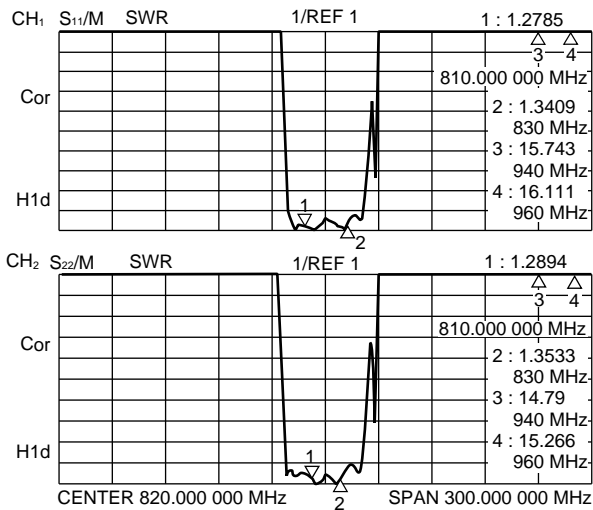
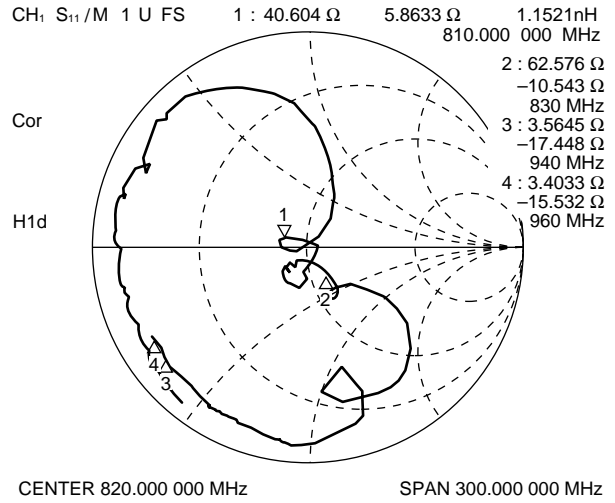
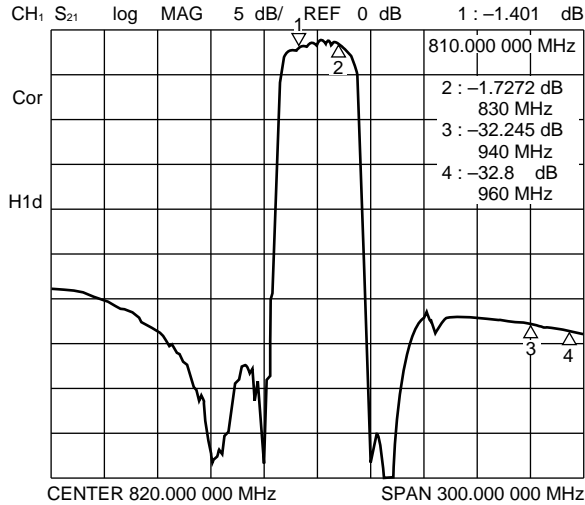

F5CH Series (L2 type)

18. PDC800 System (Rx) High Attenuation Type Part number: FAR-F5CH-820M00-L2FV

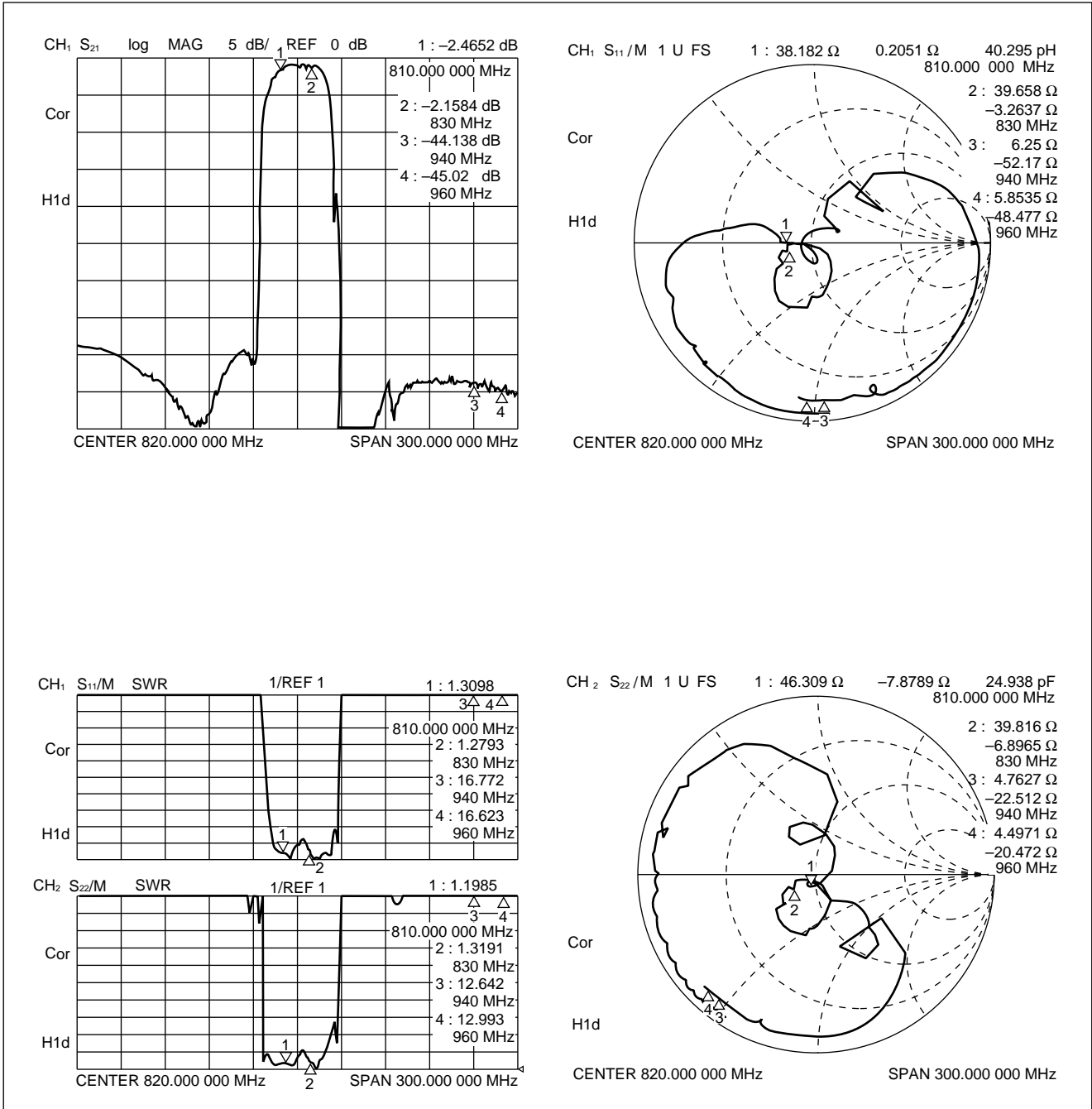

F5CH Series (L2 type)

19. DUAL BAND PDC800 System (Tx) BW; 33 MHz Part number: FAR-F5CH-940M50-L2MD

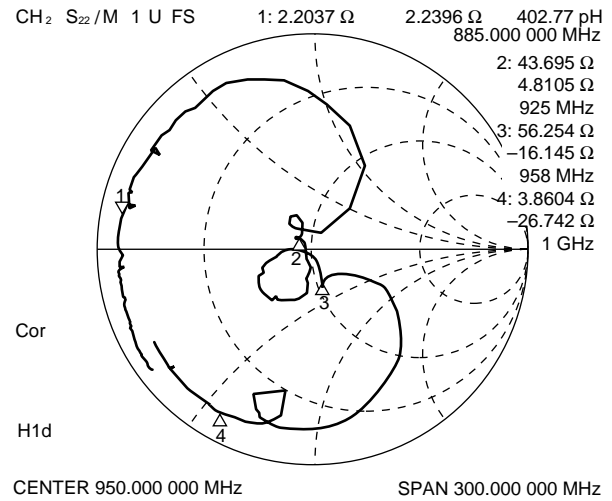
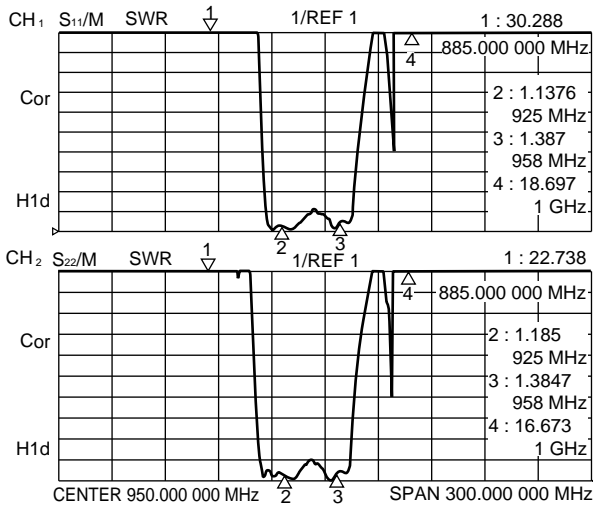
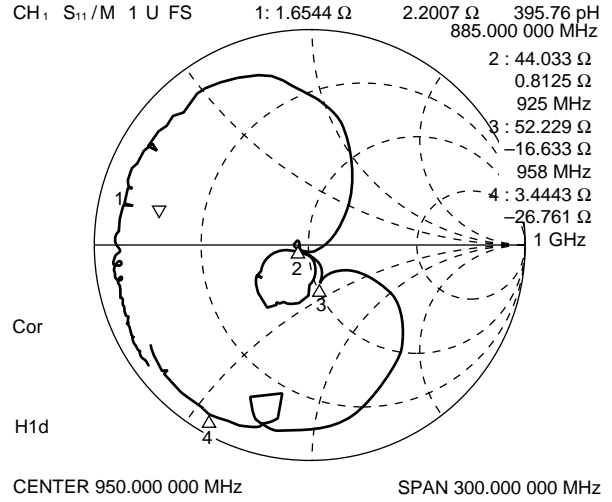
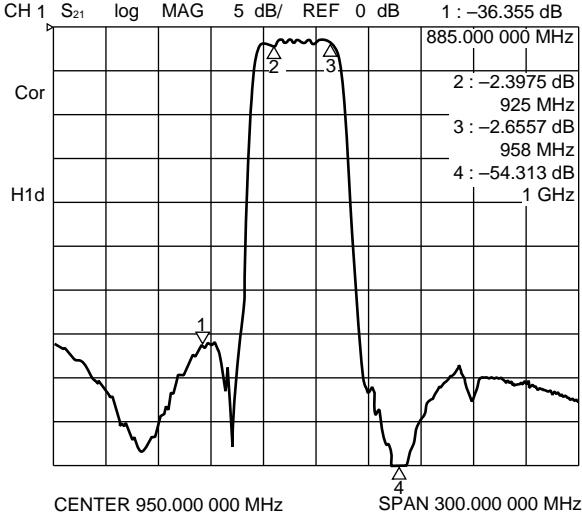

F5CH Series (L2 type)

20. ISM900 High Attenuation Type Part number: FAR-F5CH-915M00-L2JW

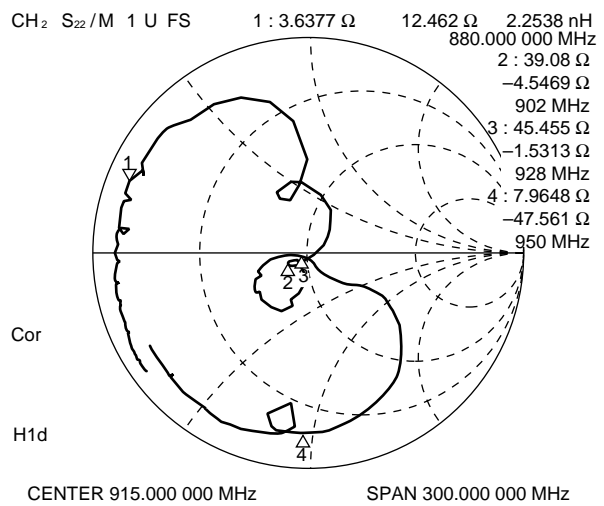
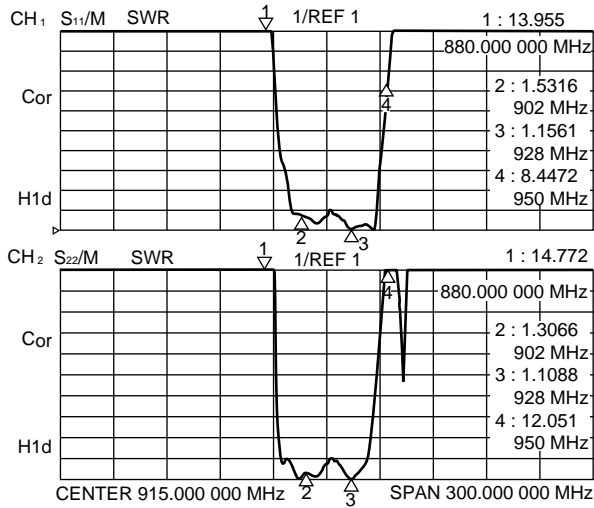
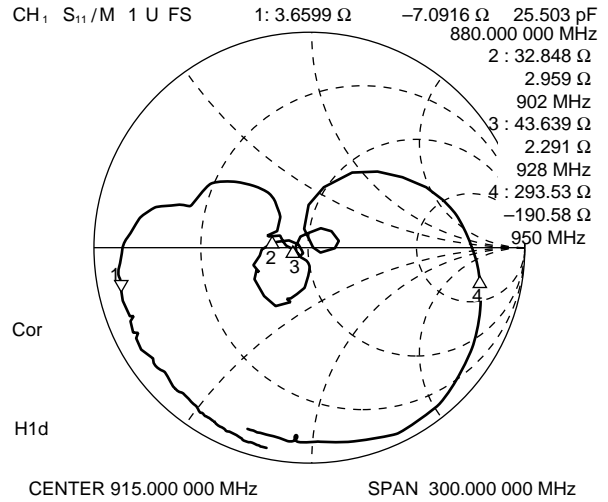
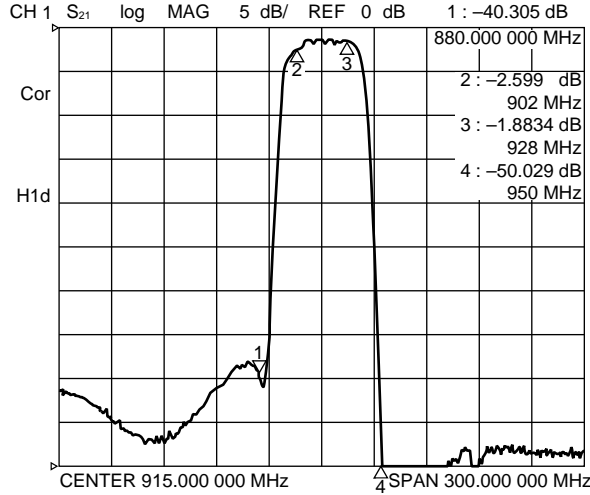

F5CH Series (L2 type)

21. N-PCS (2 Way Pager) (Rx) Part number: FAR-F5CH-935M00-L2LA

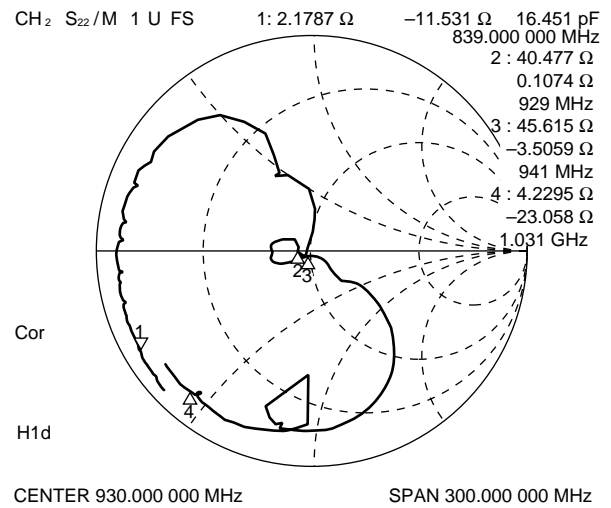
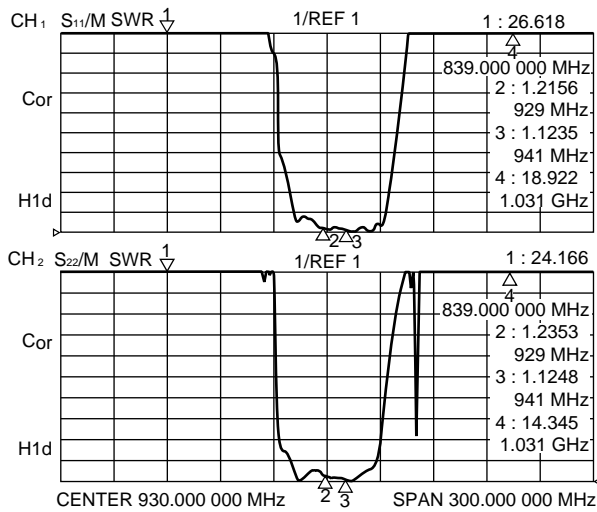
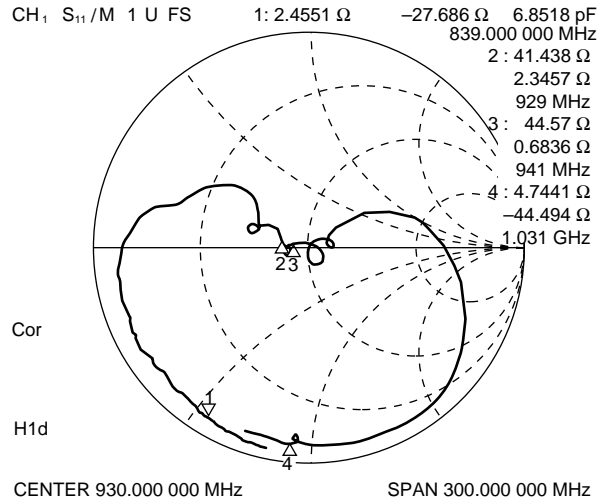
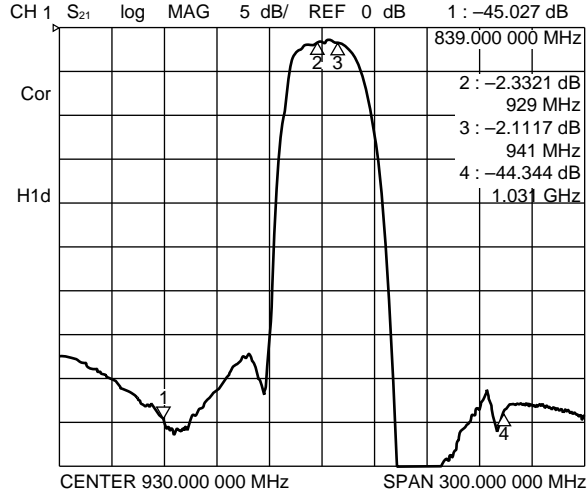

F5CH Series (L2 type)

■ MEASURING CIRCUIT

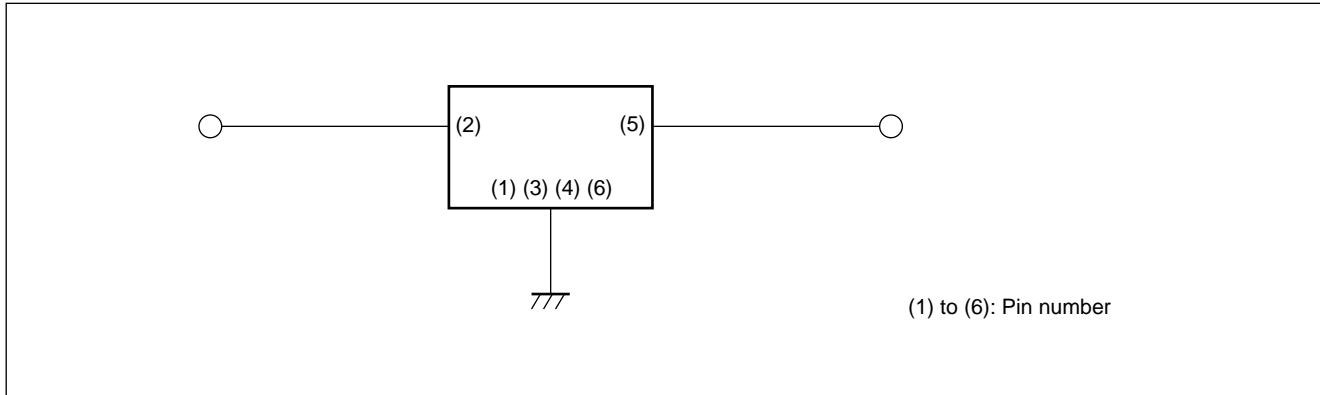

■ PART NUMBER DESIGNATION

[Designation example]

FAR-F5CH-□□□□□□-L2□□-□
(1) (2) (3)

(1)Frequency designation: Specify the nominal frequency in six alphanumeric characters.
Enter M (for MHz) at the decimal point.
Refer to standard frequencies.

[Example] 836.5 MHz ⇒ 836M50

(2)Serial number: Specify a characters from AA to KZ.
Refer to standard frequencies.

(3)Packing (Reeled tape): T:1 k pcs/reel
R: 3k pcs/reel

F5CH Series (L2 type)

■ PACKAGE DIMENSION

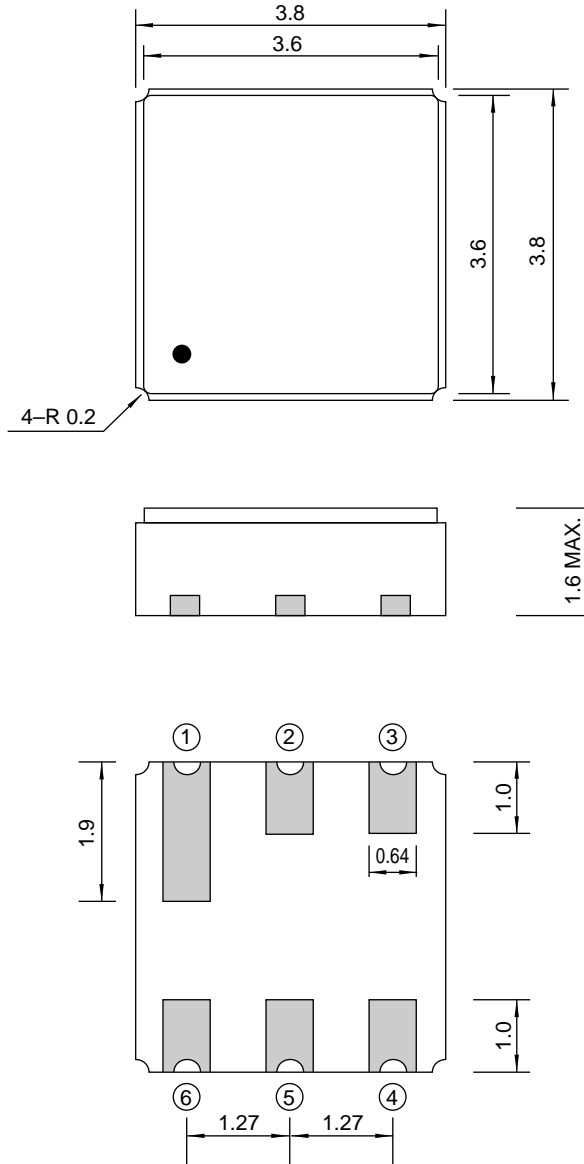

Dimensions in mm.

F5CH Series (L2 type)

MARKING

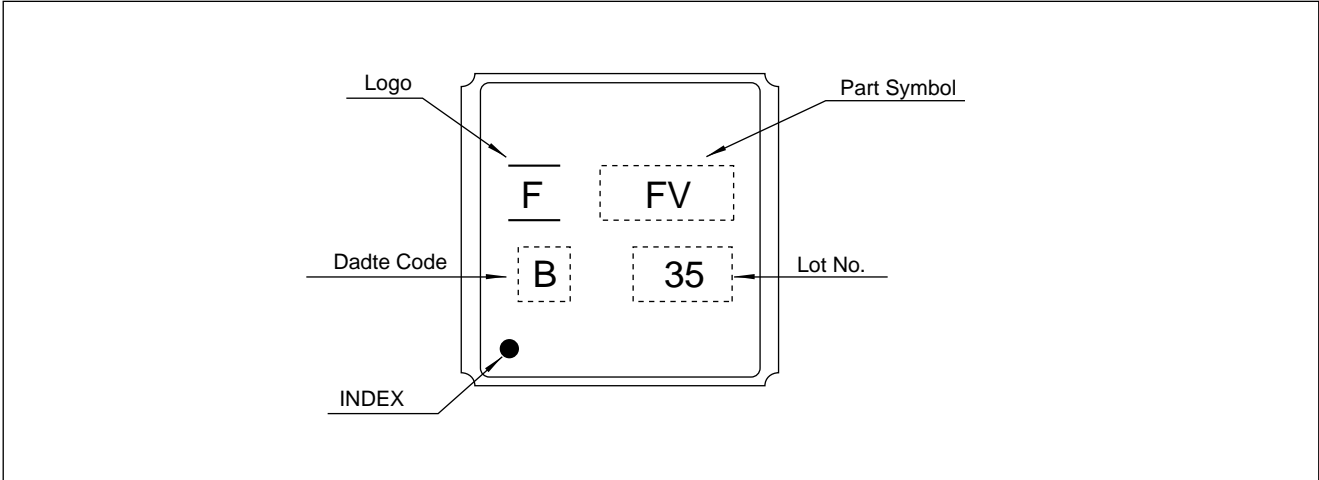

F5CH Series (L2 type)

■ PACKING: Reel type

1. Reel Dimensions

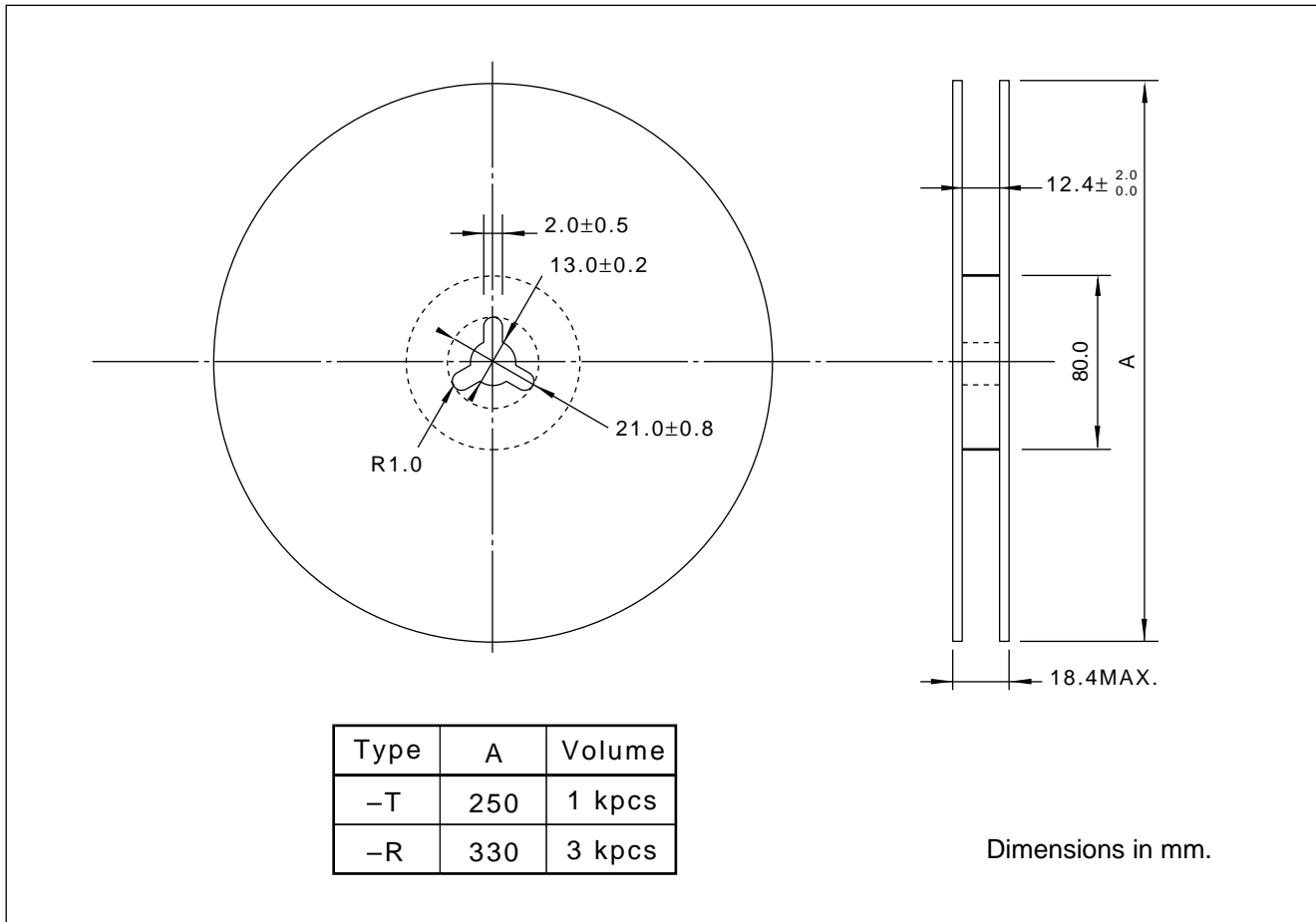

2. Packing Style

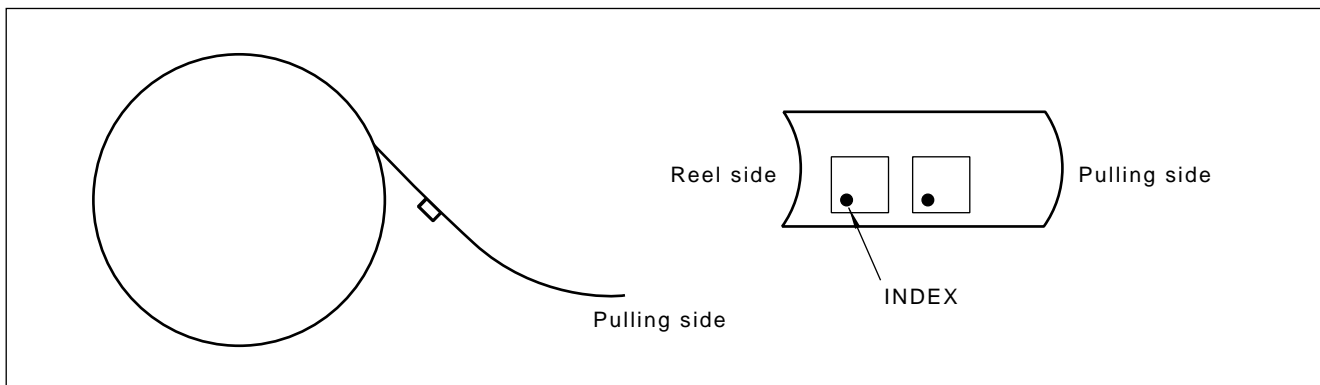

FUJITSU LIMITED

For further information please contact:

Japan

FUJITSU LIMITED
Corporate Global Business Support Division
Electronic Devices
KAWASAKI PLANT, 4-1-1, Kamikodanaka
Nakahara-ku, Kawasaki-shi
Kanagawa 211-88, Japan
Tel: (044) 754-3763
Fax: (044) 754-3329

North and South America

FUJITSU MICROELECTRONICS, INC.
Semiconductor Division
3545 North First Street
San Jose, CA 95134-1804, U.S.A.
Tel: (408) 922-9000
Fax: (408) 432-9044/9045

Europe

FUJITSU MIKROELEKTRONIK GmbH
Am Siebenstein 6-10
63303 Dreieich-Buchsschlag
Germany
Tel: (06103) 690-0
Fax: (06103) 690-122

Asia Pacific

FUJITSU MICROELECTRONICS ASIA PTE. LIMITED
#05-08, 151 Lorong Chuan
New Tech Park
Singapore 556741
Tel: (65) 281-0770
Fax: (65) 281-0220

F9703

© FUJITSU LIMITED Printed in Japan

All Rights Reserved.

The contents of this document are subject to change without notice. Customers are advised to consult with FUJITSU sales representatives before ordering.

The information and circuit diagrams in this document presented as examples of semiconductor device applications, and are not intended to be incorporated in devices for actual use. Also, FUJITSU is unable to assume responsibility for infringement of any patent rights or other rights of third parties arising from the use of this information or circuit diagrams.

FUJITSU semiconductor devices are intended for use in standard applications (computers, office automation and other office equipment, industrial, communications, and measurement equipment, personal or household devices, etc.).

CAUTION:

Customers considering the use of our products in special applications where failure or abnormal operation may directly affect human lives or cause physical injury or property damage, or where extremely high levels of reliability are demanded (such as aerospace systems, atomic energy controls, sea floor repeaters, vehicle operating controls, medical devices for life support, etc.) are requested to consult with FUJITSU sales representatives before such use. The company will not be responsible for damages arising from such use without prior approval.

Any semiconductor devices have inherently a certain rate of failure. You must protect against injury, damage or loss from such failures by incorporating safety design measures into your facility and equipment such as redundancy, fire protection, and prevention of over-current levels and other abnormal operating conditions.

If any products described in this document represent goods or technologies subject to certain restrictions on export under the Foreign Exchange and Foreign Trade Control Law of Japan, the prior authorization by Japanese government should be required for export of those products from Japan.