

Schottky Rectifier

SBT2535 — SBT2545

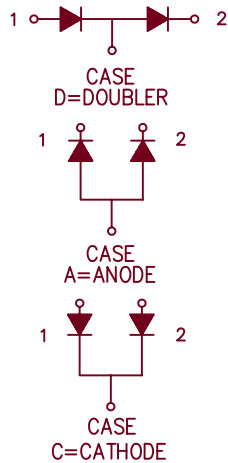
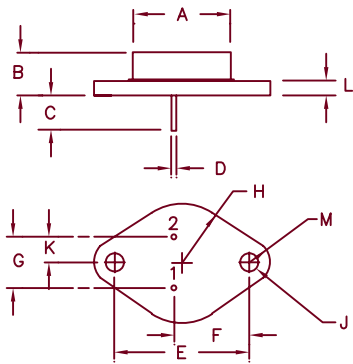

Dim.	Inches		Millimeter		Notes
	Minimum	Maximum	Minimum	Maximum	
A	—	.875	—	22.23	Dia.
B	.250	.450	6.35	11.43	
C	.435	—	11.05	—	
D	.038	.043	.97	1.09	Dia.
E	1.177	1.197	29.90	30.40	
F	.655	.675	16.64	17.15	
G	.420	.440	10.67	11.18	
H	—	.525	—	13.34	Rad.
J	.151	.161	3.84	4.09	Dia.
K	.205	.225	5.21	5.72	
L	—	.135	—	3.43	
M	—	.188	—	4.78	Rad.

TO-204AA (TO-3)

Microsemi Catalog Number	Working Peak Reverse Voltage	Repetitive Peak Reverse Voltage
SBT2535*	35V	35V
SBT2540*	40V	40V
SBT2545*	45V	45V

*ADD D, C, or A

- Schottky Barrier Rectifier
- Guard Ring Protection
- Low Forward Voltage
- V_{RRM} - 35 to 45V
- 25 Amperes
- Reverse Energy Tested

Electrical Characteristics Per Leg

Average forward current (standard)	$I_{F(AV)}$ 25 Amps	$T_C = 115^\circ\text{C}$, Square wave, $R_{\theta JC} = 1.4^\circ\text{C/W}$
Average forward current (reverse)	$I_{F(AV)}$ 25 Amps	$T_C = 92^\circ\text{C}$, Square wave, $R_{\theta JC} = 2.2^\circ\text{C/W}$
Maximum surge current	I_{FSM} 600 Amps	8.3 ms, half sine $T_J = 150^\circ\text{C}$
Max repetitive peak reverse current	$I_{R(OV)}$ 2 Amps	$f = 1 \text{ KHz}$, 25°C , 1 μsec Square wave
Max peak forward voltage	V_{FM} .53 Volts	$I_{FM} = 25\text{A}$: $T_J = 150^\circ\text{C}^*$
Max peak forward voltage	V_{FM} .58 Volts	$I_{FM} = 25\text{A}$: $T_J = 25^\circ\text{C}^*$
Max peak reverse current	I_{RM} 250 mA	V_{RRM} , $T_J = 125^\circ\text{C}^*$
Max peak reverse current	I_{RM} 2 mA	V_{RRM} , $T_J = 25^\circ\text{C}$
Typical junction capacitance per leg	C_J 1200 pF	$V_R = 5.0\text{V}$, $T_J = 25^\circ\text{C}$

*Pulse test: Pulse width 300 μsec , Duty cycle 2%

Thermal and Mechanical Characteristics

Storage temp range	T_{STG}	-65°C to 175°C
Operating junction temp range	T_J	-65°C to 150°C
Maximum thermal resistance (standard polarity)	$R_{\theta JC}$	1.4°C/W Junction to case
Maximum thermal resistance (reverse polarity)	$R_{\theta JC}$	2.2°C/W Junction to case
Typical thermal resistance (greased)	$R_{\theta CS}$	0.5°C/W Case to sink
Weight		1.0 ounces (28 grams) typical



6 Lake Street
Lawrence, MA 01841
PH: (978) 620-2600
FAX: (978) 689-0803
www.microsemi.com

05-30-07 Rev. 2

SBT2535 — SBT2545

Figure 1
Typical Forward Characteristics

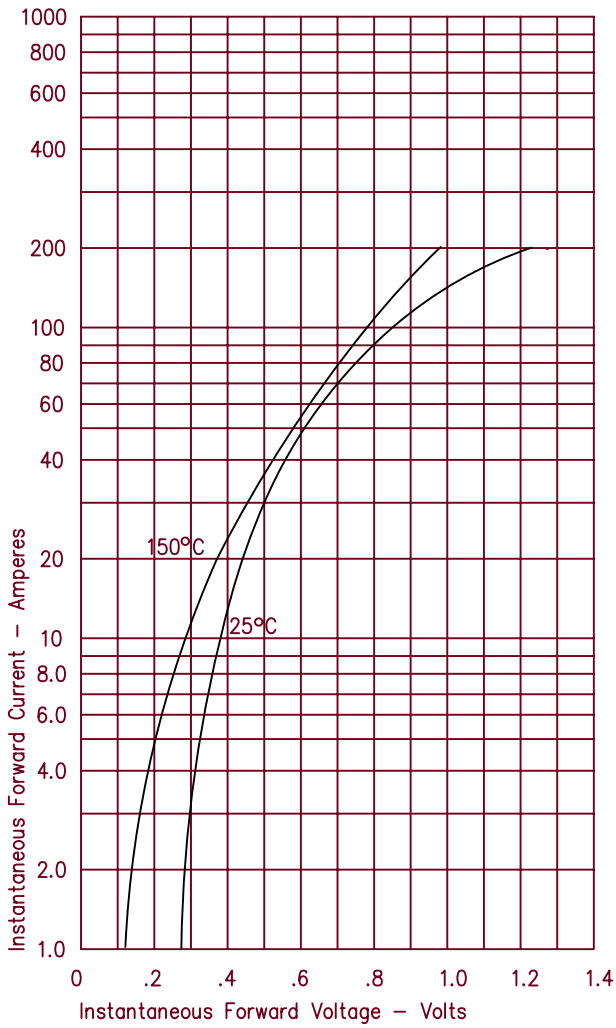

Figure 3
Typical Junction Capacitance

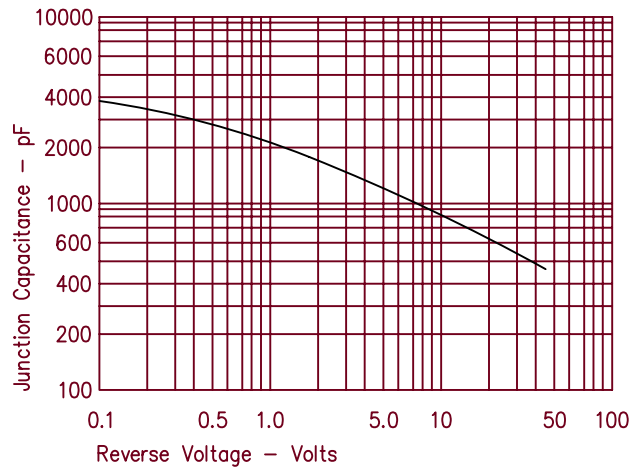

Figure 4
Forward Current Derating - Standard Polarity

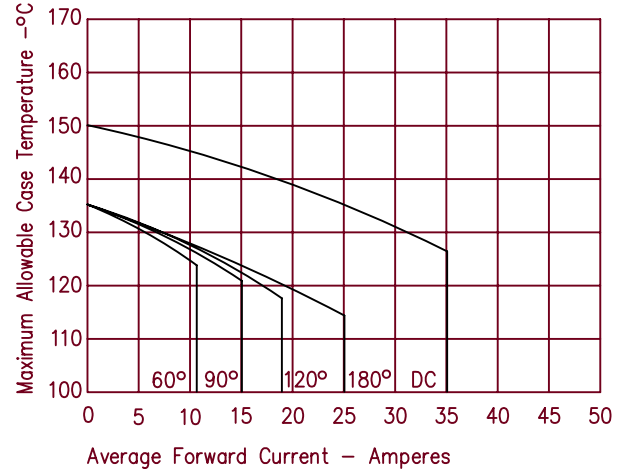

Figure 2
Typical Reverse Characteristics

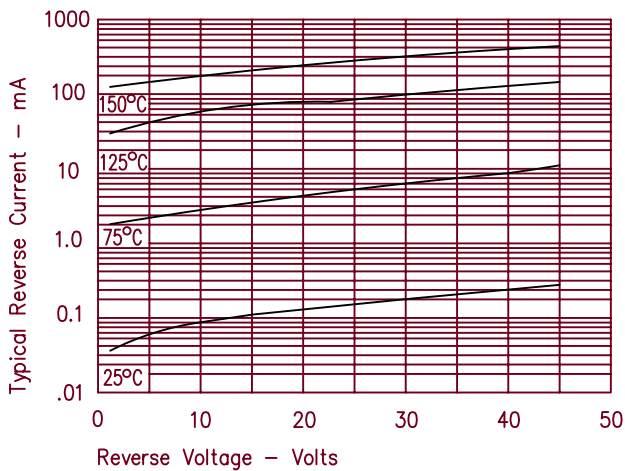
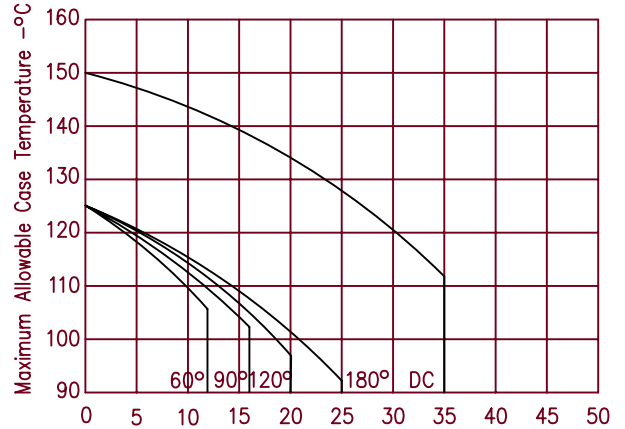

Figure 5
Forward Current Derating - Reverse Polarity



SBT2535 – SBT2545

Figure 6
Maximum Forward Power Dissipation – Standard Polarity

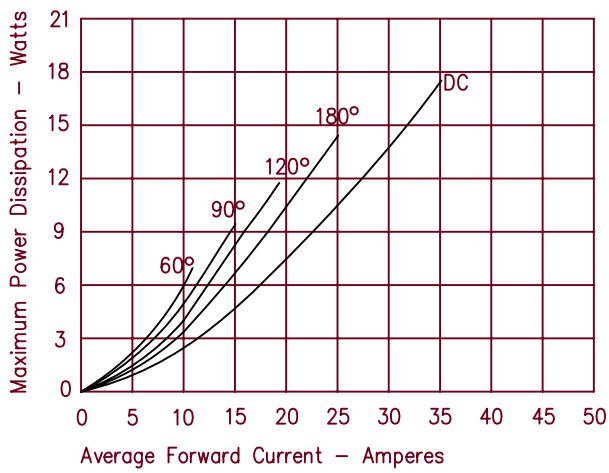

Figure 7
Maximum Forward Power Dissipation – Reverse Polarity

