

GBG1040

Description

The GBG1040 is designed for low voltage, high frequency inverter, free wheeling, and polarity protection application.

Package Dimensions

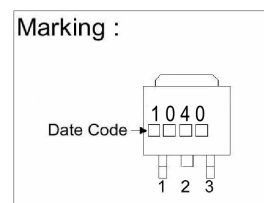
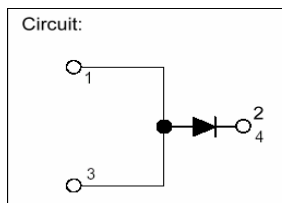
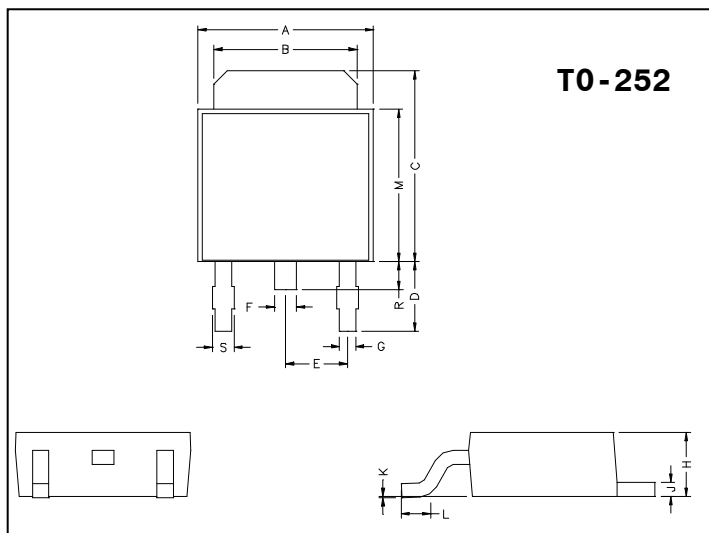

REF.	Millimeter		REF.	Millimeter	
	Min.	Max.		Min.	Max.
A	6.40	6.80	G	0.50	0.70
B	5.20	5.50	H	2.20	2.40
C	6.80	7.20	J	0.45	0.55
D	2.20	2.80	K	0	0.15
E	2.30 REF.		L	0.90	1.50
F	0.70	0.90	M	5.40	5.80
S	0.60	0.90	R	0.80	1.20

Absolute Maximum Ratings

Parameter	Symbol	Ratings	Unit
Junction Temperature	T_j	-40~+125	°C
Storage Temperature	T_{stg}	-40~+125	°C
Typical Thermal Resistance Junction to Case	$R_{\theta JC}$	3.0	°C/W
Typical Junction Capacitance	C_j	405	pF
Reverse Leakage Current @ $T_j = 25\text{ °C}$ $V_R=40V$	I_{RM}	0.3	mA
Reverse Leakage Current @ $T_j = 125\text{ °C}$ $V_R=40V$		40	mA
Forward Voltage Drop @ $I_F = 10A$, $T_j = 25\text{ °C}$	V_{FM}	0.65	V
Forward Voltage Drop @ $I_F = 10A$, $T_j = 125\text{ °C}$		0.6	V
Non-Repetitive Peak Forward Surge Current 5Us Single half Sine-wave superimposed on rated load	I_{FSM}	340	A
Non-Repetitive Peak Forward Surge Current 10ms Single half Sine-wave superimposed on rated load		70	
Rectangular waveform	I_F	10	A
RMS Reverse Voltage	$V_{R(RMS)}$	40	V
Peak Repetitive Reverse Voltage	V_{RRM}		V

Characteristics Curve

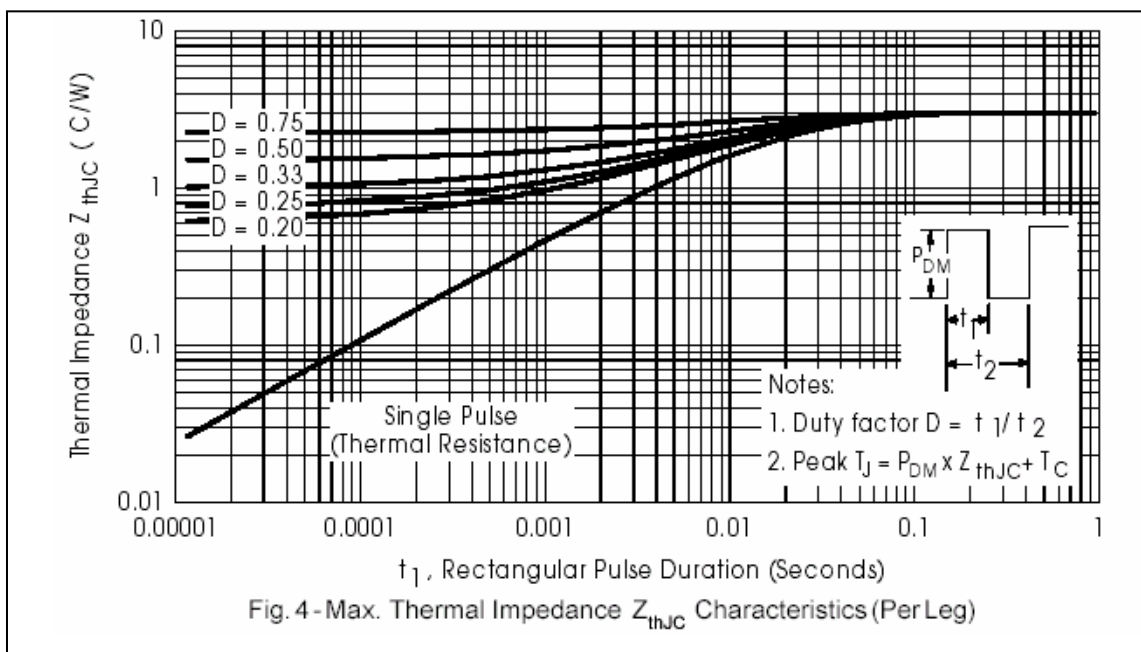
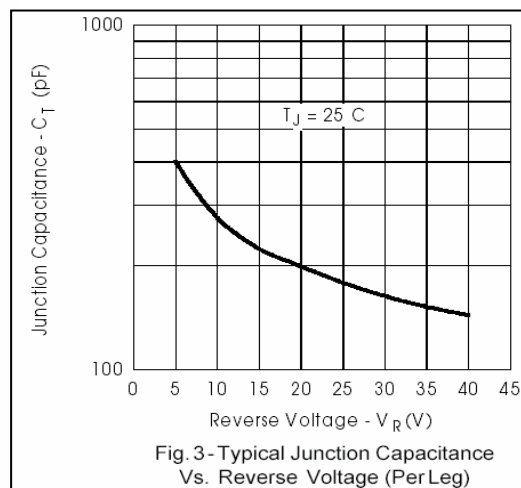
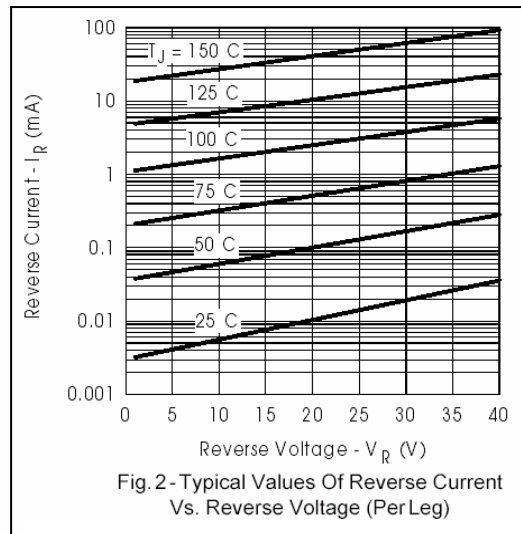
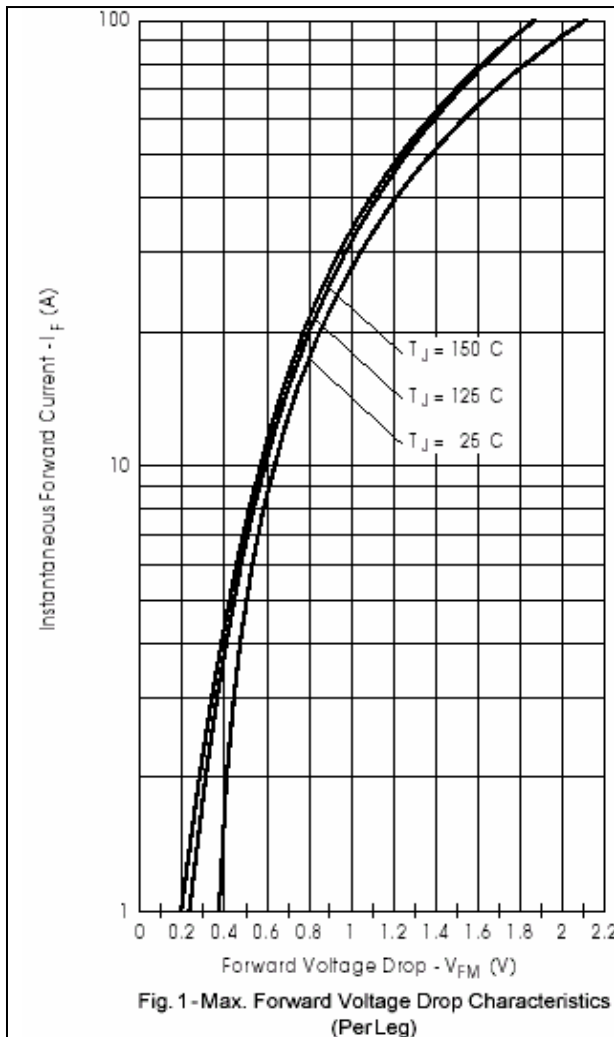

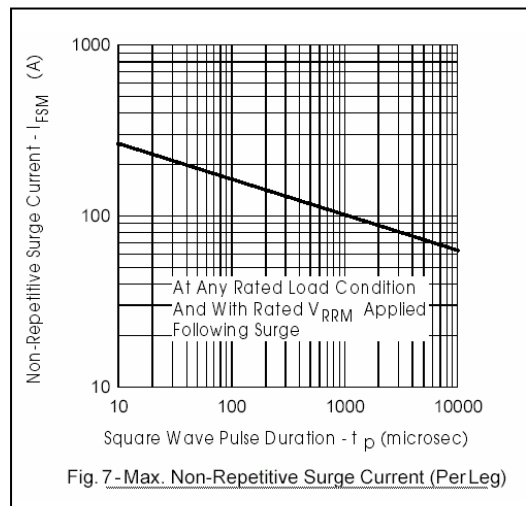
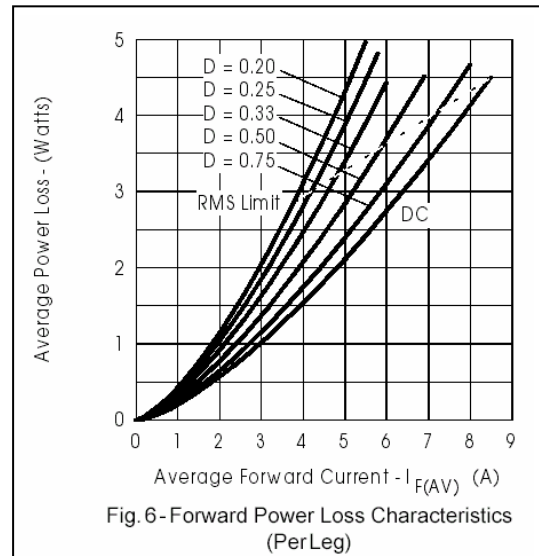
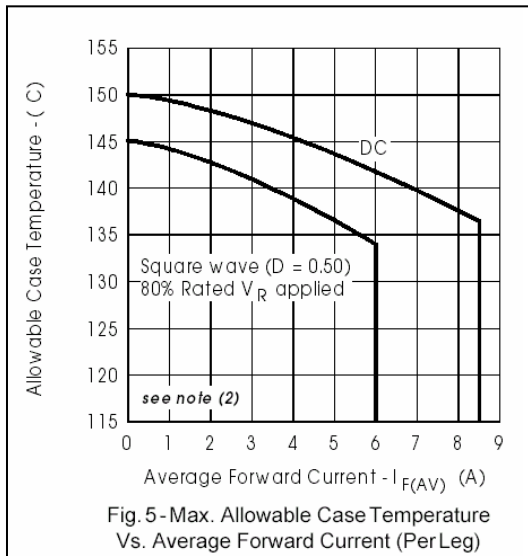

Important Notice:

- All rights are reserved. Reproduction in whole or in part is prohibited without the prior written approval of GTM.
- GTM reserves the right to make changes to its products without notice.
- GTM semiconductor products are not warranted to be suitable for use in life-support Applications, or systems.
- GTM assumes no liability for any consequence of customer product design, infringement of patents, or application assistance.

Head Office And Factory:

- **Taiwan:** No. 17-1 Tatung Rd. Fu Kou Hsin-Chu Industrial Park, Hsin-Chu, Taiwan, R. O. C.
TEL : 886-3-597-7061 FAX : 886-3-597-9220, 597-0785
- **China:** (201203) No.255, Jang-Jiang Tsai-Lueng RD. , Pu-Dung-Hsin District, Shang-Hai City, China
TEL : 86-21-58957671 FAX : 86-21-38950165