

Silicon NPN Power Transistors

2N6537

DESCRIPTION

- With TO-66 package
- DARLINGTON

APPLICATIONS

- Power switching
- Hammer drivers
- Series and shunt regulators
- Audio amplifiers

PINNING (See Fig.2)

PIN	DESCRIPTION
1	Base
2	Emitter
3	Collector

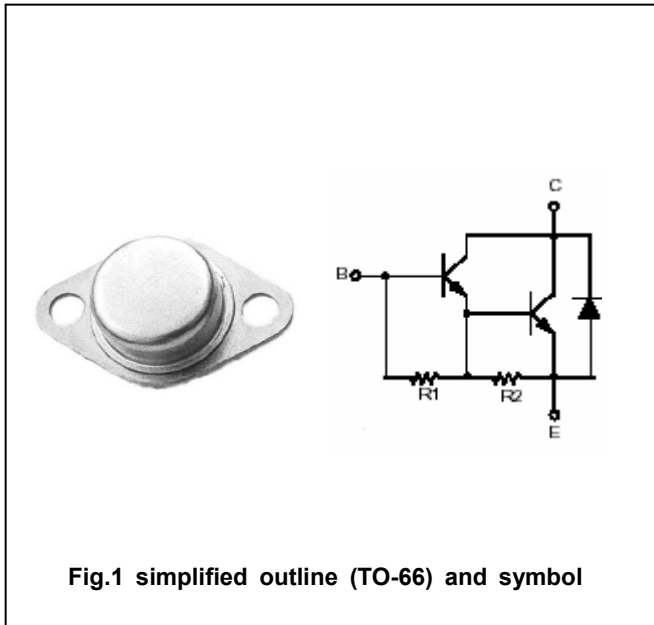

Absolute maximum ratings(Ta=25°C)

SYMBOL	PARAMETER	CONDITIONS	VALUE	UNIT
V _{CBO}	Collector-base voltage	Open emitter	120	V
V _{CEO}	Collector-emitter voltage	Open base	120	V
V _{EBO}	Emitter-base voltage	Open collector	5	V
I _C	Collector current		8	A
I _{CM}	Collector current-Peak		15	A
I _B	Base current		0.25	A
P _T	Total power dissipation	T _C =25°C	36	W
T _j	Junction temperature		150	°C
T _{stg}	Storage temperature		-65~150	°C

Silicon NPN Power Transistors

2N6537

CHARACTERISTICS

T_j=25°C unless otherwise specified

SYMBOL	PARAMETER	CONDITIONS	MIN	TYP.	MAX	UNIT
V _{CEO(SUS)}	Collector-emitter sustaining voltage	I _C =0.2A ; I _B =0	120			V
V _{CEsat-1}	Collector-emitter saturation voltage	I _C =3A ; I _B =6mA			2.0	V
V _{CEsat-2}	Collector-emitter saturation voltage	I _C =8A ; I _B =80mA			3.0	V
V _{BE-1}	Base -emitter on voltage	I _C =3A ; V _{CE} =3V			2.8	V
V _{BE-2}	Base -emitter on voltage	I _C =8A ; V _{CE} =3V			4.5	V
I _{CEV}	Collector cut-off current	V _{CE} =120V ; V _{BE} =-1.5V T _C =125°C			0.5 5.0	mA
I _{CEO}	Collector cut-off current	V _{CE} =120V ; I _B =0			1.0	mA
I _{EBO}	Emitter cut-off current	V _{EB} =5V ; I _C =0			5.0	mA
h _{FE-1}	DC current gain	I _C =3A ; V _{CE} =3V	1000		10000	
h _{FE-2}	DC current gain	I _C =8A ; V _{CE} =3V	100		5000	
V _F	Diode forward voltage	I _F =5A			4.0	V

PACKAGE OUTLINE

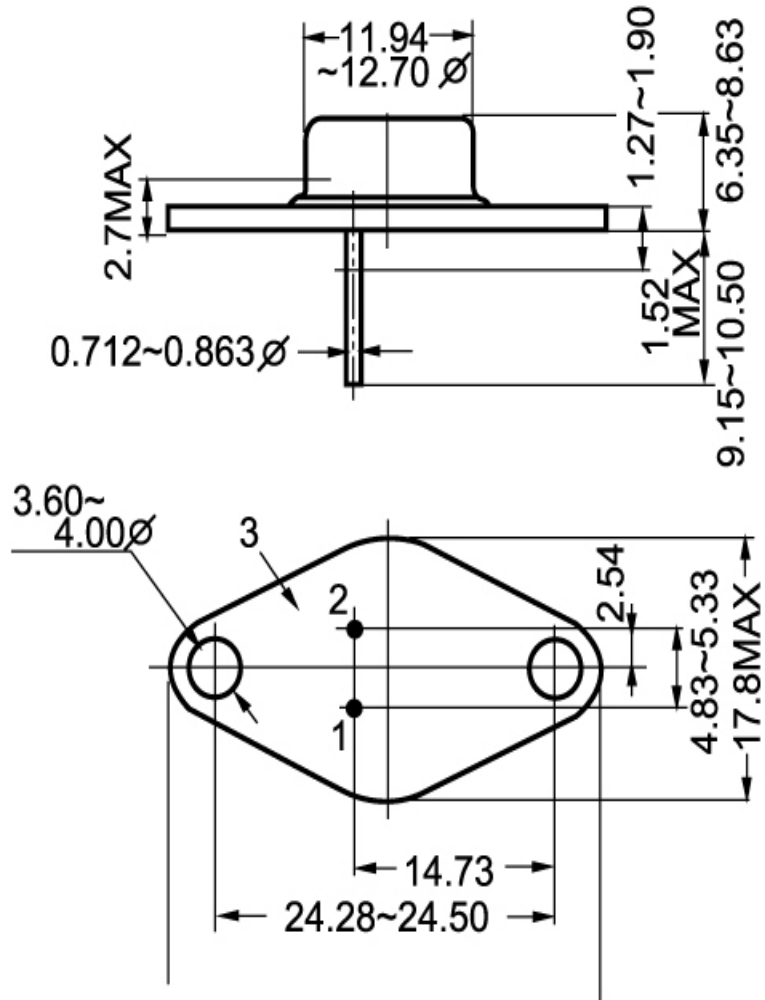

Fig.2 Outline dimensions