



## MD2310FX

High voltage NPN Power transistor for standard definition CRT display

### Features

- State-of-the-art technology:
  - diffused collector “enhanced generation”
- More stable performance versus operating temperature variation
- Low base drive requirement
- Tighter  $h_{FE}$  range at operating collector current
- Fully insulated power package u.l. compliant
- In compliance with the 2002/93/EC european directive

### Applications

- Horizontal deflection output for monitor and real flat tv

### Description

The MD2310FX is manufactured using Diffused Collector in Planar Technology adopting new and enhanced high voltage structure. The new MD product series show improved silicon efficiency bringing updated performance to the Horizontal Deflection stage.

### Order codes

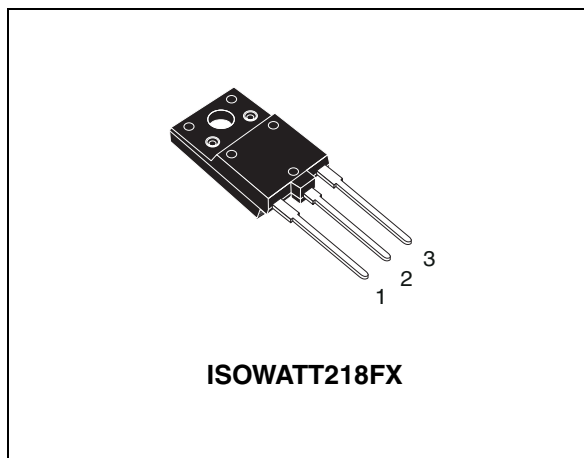

### Internal Schematic Diagram

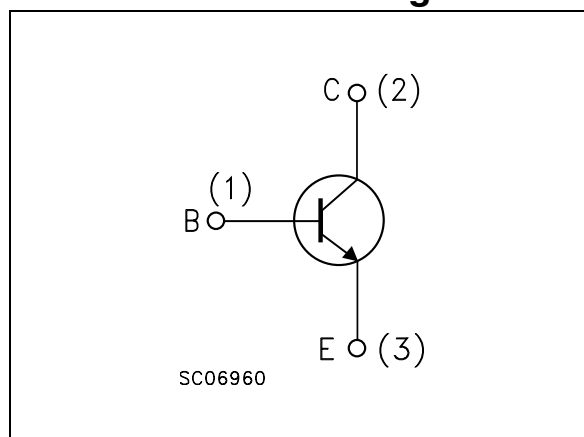

Part number	Marking	Package	Packing
MD2310FX	MD2310FX	ISOWATT218FX	TUBE

# 1 Electrical ratings

**Table 1. Absolute maximum rating**

Symbol	Parameter	Value	Unit
$V_{CES}$	Collector-emitter voltage ( $V_{BE} = 0$ )	1500	V
$V_{CEO}$	Collector-emitter voltage ( $I_B = 0$ )	700	V
$V_{EBO}$	Collector-base voltage ( $I_C = 0$ )	9	V
$I_C$	Collector current	14	A
$I_{CM}$	Collector peak current ( $t_p < 5\text{ms}$ )	21	A
$I_B$	Base current	7	A
$P_{TOT}$	Total dissipation at $T_c = 25^\circ\text{C}$	62	W
$V_{inso}$	Insulation withstand voltage (RMS) from all three leads to external heatsink	2500	V
$T_{stg}$	Storage temperature	-65 to 150	°C
$T_J$	Max. operating junction temperature		

**Table 2. Thermal data**

Symbol	Parameter	Value	Unit
$R_{thj-case}$	Thermal resistance junction-case Max	2	°C/W

## 2 Electrical characteristics

( $T_{CASE} = 25^{\circ}C$ ; unless otherwise specified)

**Table 3. Electrical characteristics**

Symbol	Parameter	Test conditions	Min.	Typ.	Max.	Unit
$I_{CES}$	Collector cut-off current ( $V_{BE} = 0$ )	$V_{CE} = 1500V$			0.2	mA
		$V_{CE} = 1500V$ $T_C = 125^{\circ}C$			2	mA
$I_{EBO}$	Emitter cut-off current ( $I_C = 0$ )	$V_{EB} = 9V$			1	mA
$V_{CEO(sus)}$	Collector-emitter sustaining voltage ( $I_C = 0$ )	$I_C = 100$ mA	700			V
$V_{CE(sat)}$ <i>Note 1</i>	Collector-emitter saturation voltage	$I_C = 7$ A $I_B = 1.75$ A			2.5	V
$V_{BE(sat)}$ <i>Note 1</i>	Base-emitter saturation voltage	$I_C = 7$ A $I_B = 1.75$ A			1.1	V
$h_{FE}$ <i>Note 1</i>	DC current gain	$I_C = 1$ A $V_{CE} = 5$ V		28		
		$I_C = 7$ A $V_{CE} = 1$ V		5.5		
		$I_C = 7$ A $V_{CE} = 5$ V	6		8.5	
$t_s$ $t_f$	INDUCTIVE LOAD	$I_C = 6$ A $f_h = 64$ KHz				
	Storage time	$I_{B(on)} = 0.9$ A $V_{BE(off)} = -2.7$ V		2.3	2.8	$\mu$ s
	Fall time	$L_{BB(off)} = 1.6$ $\mu$ H		0.12	0.25	$\mu$ s

1 Pulsed duration = 300  $\mu$ s, duty cycle  $\leq 1.5\%$ .

## 2.1 Typical characteristics

Figure 1. Safe operating area

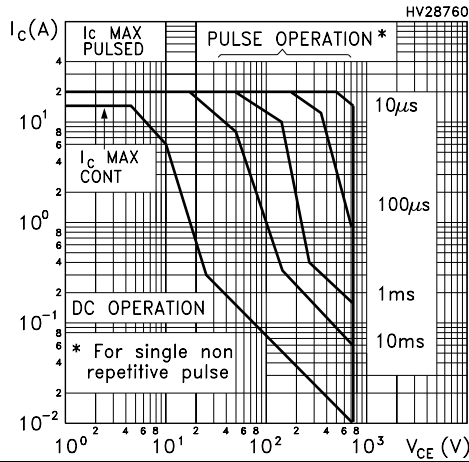

Figure 3. Output characteristics

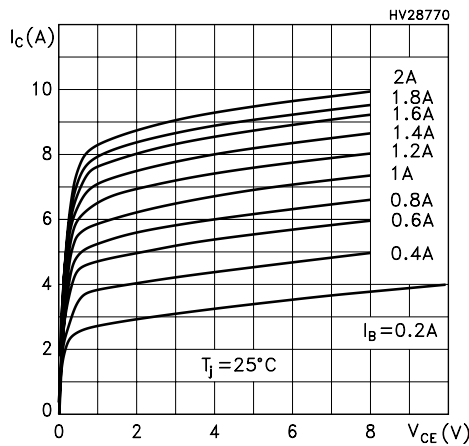

Figure 5. DC current gain

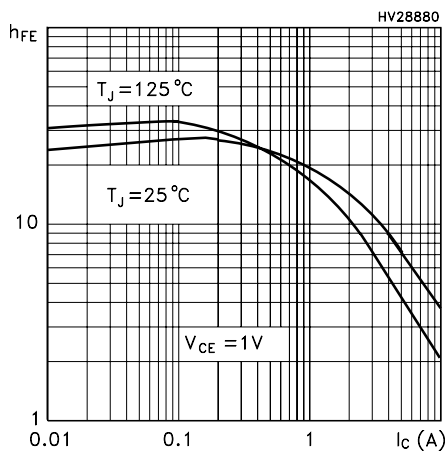

Figure 2. Derating curve

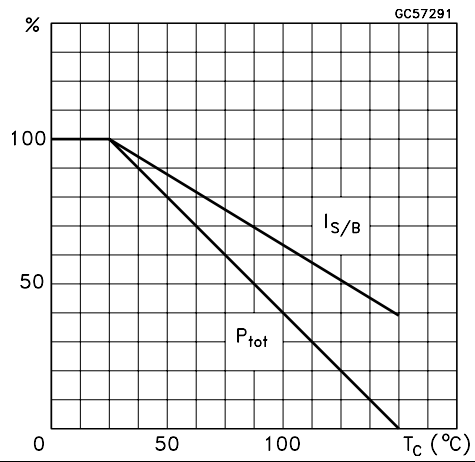

Figure 4. Reverse biased SOA

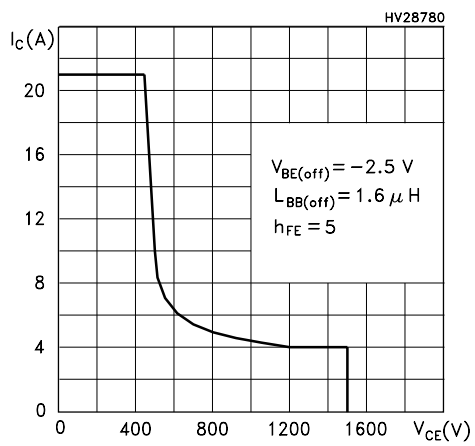

Figure 6. DC current gain

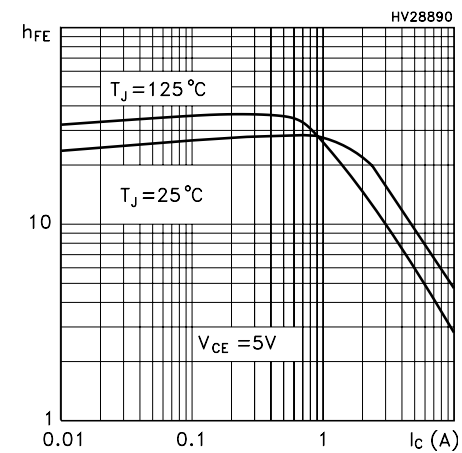

Figure 7. Collector-emitter saturation voltage Figure 8. Base-emitter saturation voltage

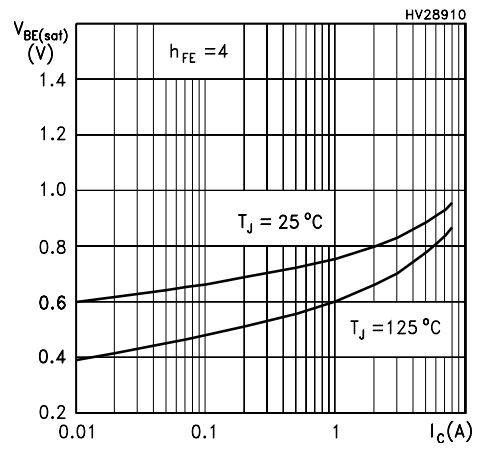
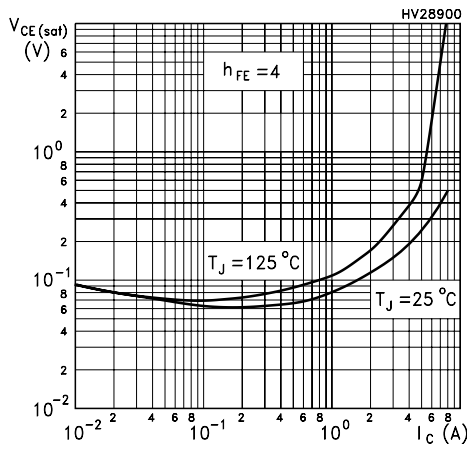
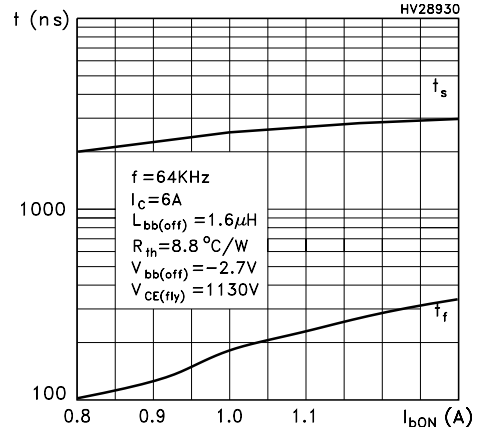
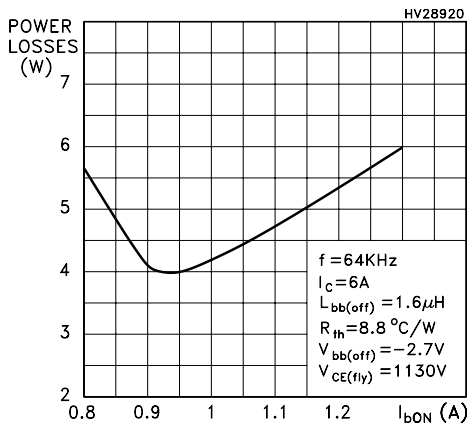

Figure 9. Power losses

Figure 10. Inductive load switching time



### 3 Test circuits

Figure 11. Power losses and inductive load switching test circuit

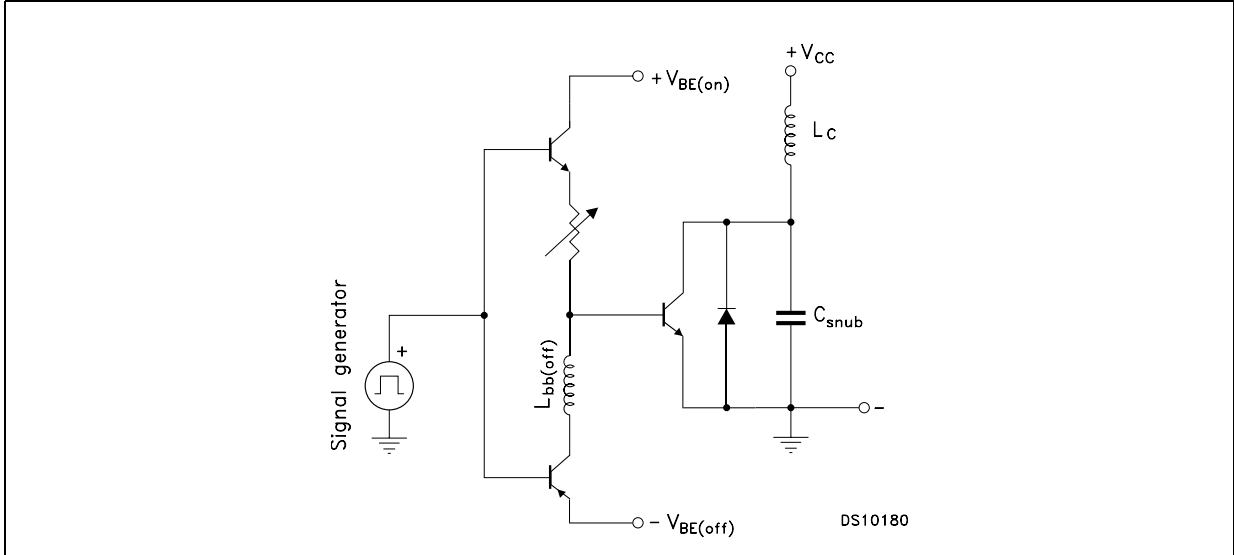
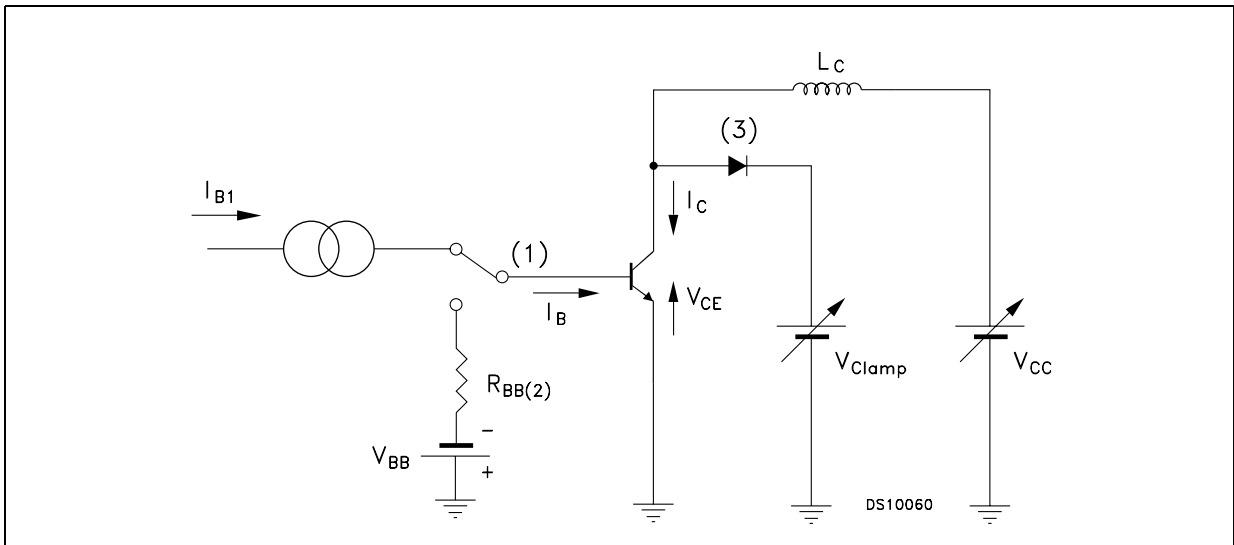

Figure 12. Reverse biased safe operating area test circuit



## 4 Package mechanical data

In order to meet environmental requirements, ST offers these devices in ECOPACK® packages. These packages have a Lead-free second level interconnect . The category of second level interconnect is marked on the package and on the inner box label, in compliance with JEDEC Standard JESD97. The maximum ratings related to soldering conditions are also marked on the inner box label. ECOPACK is an ST trademark. ECOPACK specifications are available at: [www.st.com](http://www.st.com)

**ISOWATT218FX MECHANICAL DATA**

DIM.	mm.		
	MIN.	TYP	MAX.
A	5.30		5.70
C	2.80		3.20
D	3.10		3.50
D1	1.80		2.20
E	0.80		1.10
F	0.65		0.95
F2	1.80		2.20
G	10.30		11.50
G1		5.45	
H	15.30		15.70
L	9		10.20
L2	22.80		23.20
L3	26.30		26.70
L4	43.20		44.40
L5	4.30		4.70
L6	24.30		24.70
L7	14.60		15
N	1.80		2.20
R	3.80		4.20
Dia	3.40		3.80

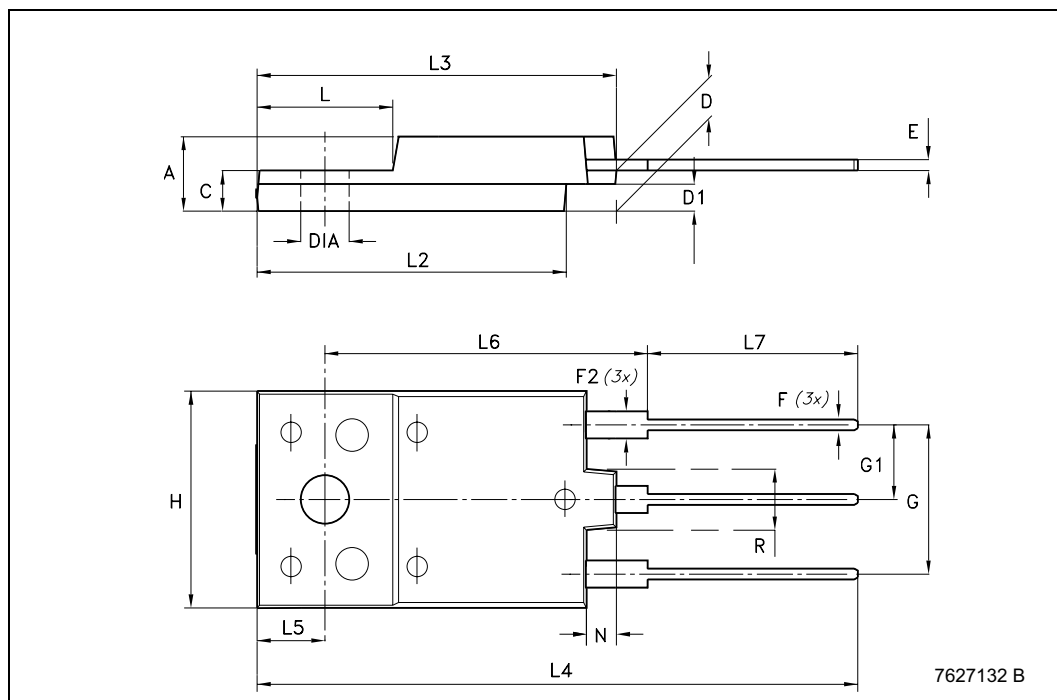



## 5 Revision history

Table 4. Revision history

Date	Revision	Changes
18-Oct-2005	1	First release
25-Nov-2005	2	Complete datasheet
15-Dec-2005	3	Legal page inserted
29-Sep-2006	4	New $h_{FE}$ limit

**Please Read Carefully:**

Information in this document is provided solely in connection with ST products. STMicroelectronics NV and its subsidiaries ("ST") reserve the right to make changes, corrections, modifications or improvements, to this document, and the products and services described herein at any time, without notice.

All ST products are sold pursuant to ST's terms and conditions of sale.

Purchasers are solely responsible for the choice, selection and use of the ST products and services described herein, and ST assumes no liability whatsoever relating to the choice, selection or use of the ST products and services described herein.

No license, express or implied, by estoppel or otherwise, to any intellectual property rights is granted under this document. If any part of this document refers to any third party products or services it shall not be deemed a license grant by ST for the use of such third party products or services, or any intellectual property contained therein or considered as a warranty covering the use in any manner whatsoever of such third party products or services or any intellectual property contained therein.

**UNLESS OTHERWISE SET FORTH IN ST'S TERMS AND CONDITIONS OF SALE ST DISCLAIMS ANY EXPRESS OR IMPLIED WARRANTY WITH RESPECT TO THE USE AND/OR SALE OF ST PRODUCTS INCLUDING WITHOUT LIMITATION IMPLIED WARRANTIES OF MERCHANTABILITY, FITNESS FOR A PARTICULAR PURPOSE (AND THEIR EQUIVALENTS UNDER THE LAWS OF ANY JURISDICTION), OR INFRINGEMENT OF ANY PATENT, COPYRIGHT OR OTHER INTELLECTUAL PROPERTY RIGHT.**

**UNLESS EXPRESSLY APPROVED IN WRITING BY AN AUTHORIZED ST REPRESENTATIVE, ST PRODUCTS ARE NOT RECOMMENDED, AUTHORIZED OR WARRANTED FOR USE IN MILITARY, AIR CRAFT, SPACE, LIFE SAVING, OR LIFE SUSTAINING APPLICATIONS, NOR IN PRODUCTS OR SYSTEMS WHERE FAILURE OR MALFUNCTION MAY RESULT IN PERSONAL INJURY, DEATH, OR SEVERE PROPERTY OR ENVIRONMENTAL DAMAGE. ST PRODUCTS WHICH ARE NOT SPECIFIED AS "AUTOMOTIVE GRADE" MAY ONLY BE USED IN AUTOMOTIVE APPLICATIONS AT USER'S OWN RISK.**

Resale of ST products with provisions different from the statements and/or technical features set forth in this document shall immediately void any warranty granted by ST for the ST product or service described herein and shall not create or extend in any manner whatsoever, any liability of ST.

ST and the ST logo are trademarks or registered trademarks of ST in various countries.

Information in this document supersedes and replaces all information previously supplied.

The ST logo is a registered trademark of STMicroelectronics. All other names are the property of their respective owners.

© 2006 STMicroelectronics - All rights reserved

STMicroelectronics group of companies

Australia - Belgium - Brazil - Canada - China - Czech Republic - Finland - France - Germany - Hong Kong - India - Israel - Italy - Japan - Malaysia - Malta - Morocco - Singapore - Spain - Sweden - Switzerland - United Kingdom - United States of America

[www.st.com](http://www.st.com)