

COMPLEMENTARY SILICON POWER DARLINGTON TRANSISTORS

- SGS-THOMSON PREFERRED SALESTYPES
- COMPLEMENTARY PNP - NPN DEVICES
- INTEGRATED ANTIPARALLEL COLLECTOR-EMITTER DIODE

APPLICATIONS

- LINEAR AND SWITCHING INDUSTRIAL EQUIPMENT

DESCRIPTION

The BDW93B, and BDW93C are silicon epitaxial-base NPN power transistors in monolithic Darlington configuration and are mounted in Jedec TO-220 plastic package. They are intended for use in power linear and switching applications.

The complementary PNP types are the BDW94B and BDW94C respectively.

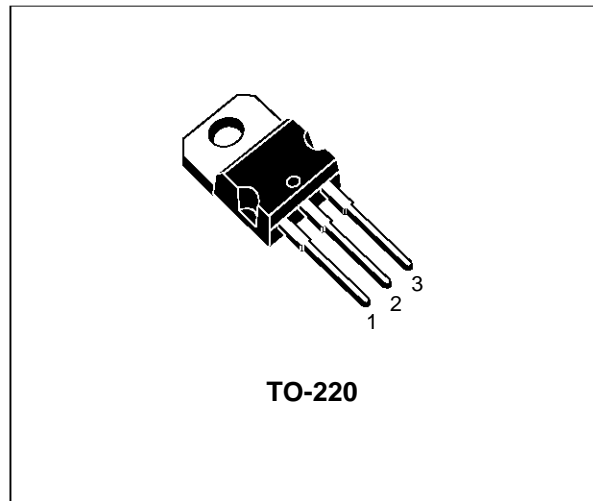

INTERNAL SCHEMATIC DIAGRAM

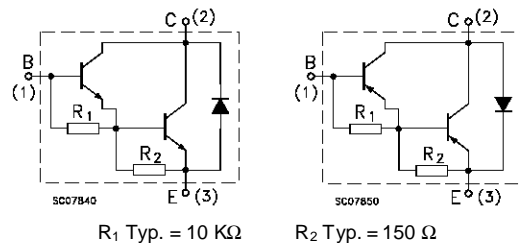

ABSOLUTE MAXIMUM RATINGS

Symbol	Parameter	Value		Unit	
		NPN	BDW93B		BDW93C
		PNP	BDW94B	BDW94C	
V_{CBO}	Collector-Base Voltage ($I_E = 0$)		80	100	V
V_{CEO}	Collector-Emitter Voltage ($I_B = 0$)		80	100	V
I_C	Collector Current		12		A
I_{CM}	Collector Peak Current		15		A
I_B	Base Current		0.2		A
P_{tot}	Total Dissipation at $T_c \leq 25^\circ C$		80		W
T_{stg}	Storage Temperature		-65 to 150		$^\circ C$
T_j	Max. Operating Junction Temperature		150		$^\circ C$

For PNP types voltage and current values are negative.

BDW93B/BDW93C/BDW94B/BDW94C

THERMAL DATA

R _{thj-case}	Thermal Resistance Junction-case	1.56	°C/W
-----------------------	----------------------------------	------	------

ELECTRICAL CHARACTERISTICS (T_{case} = 25 °C unless otherwise specified)

Symbol	Parameter	Test Conditions	Min.	Typ.	Max.	Unit
I _{CBO}	Collector Cut-off Current (I _E = 0)	for BDW93B/94B V _{CB} = 80 V for BDW93C/94C V _{CB} = 100 V T _{case} = 150 °C for BDW93B/94B V _{CB} = 80 V for BDW93C/94C V _{CB} = 100 V			100 100 5 5	μA μA mA mA
I _{CEO}	Collector Cut-off Current (I _B = 0)	for BDW93B/94B V _{CB} = 80 V for BDW93C/94C V _{CB} = 100 V			1 1	mA mA
I _{EBO}	Emitter Cut-off Current (I _C = 0)	V _{EB} = 5 V			2	mA
V _{CEO(sus)*}	Collector-Emitter Sustaining Voltage (I _B = 0)	I _C = 100 mA for BDW93B/94B for BDW93C/94C	80 100			V V
V _{CE(sat)*}	Collector-Emitter Saturation Voltage	I _C = 5 A I _B = 20 mA I _C = 10 A I _B = 100 mA			2 3	V V
V _{BE(sat)*}	Base-Emitter Saturation Voltage	I _C = 5 A I _B = 20 mA I _C = 10 A I _B = 100 mA			2.5 4	V V
h _{FE*}	DC Current Gain	I _C = 3 A V _{CE} = 3 V I _C = 5 A V _{CE} = 3 V I _C = 10 A V _{CE} = 3 V	1000 750 100		20K	
V _{F*}	Parallel-diode Forward Voltage	I _F = 5 A I _F = 10 A		1.3 1.8	2 4	V V
h _{fe} :	Small Signal Current Gain	I _C = 1 A V _{CE} = 10 V f = 1 MHz	20			

* Pulsed: Pulse duration = 300 μs, duty cycle 1.5 %
For PNP types voltage and current values are negative.

Safe Operating Area

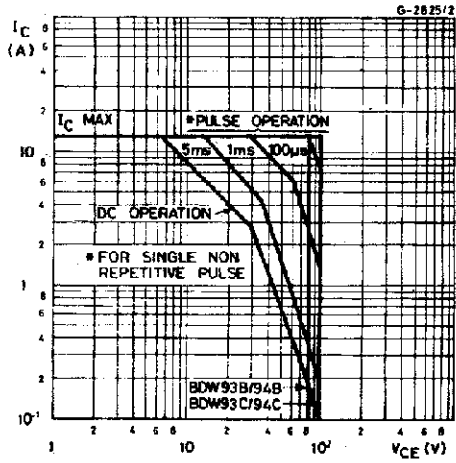

DC Current Gain (NPN types)

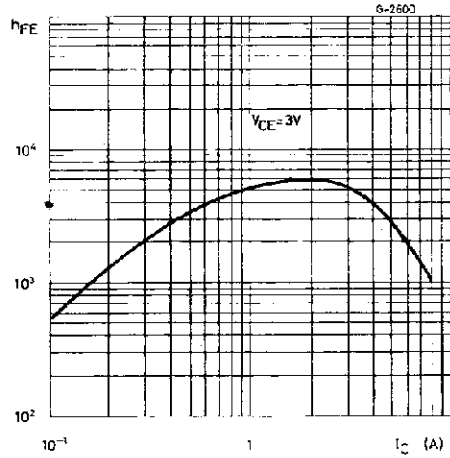

Collector Emitter Saturation Voltage (NPN types)

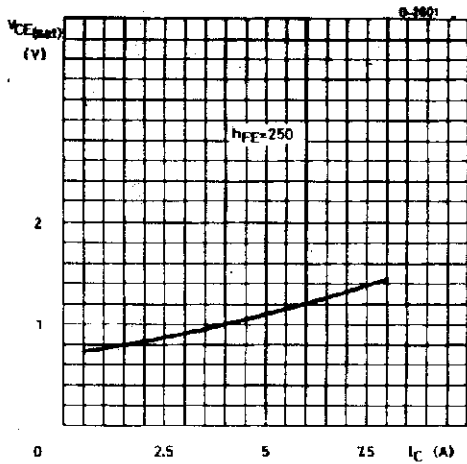

DC Transconductance (NPN types)

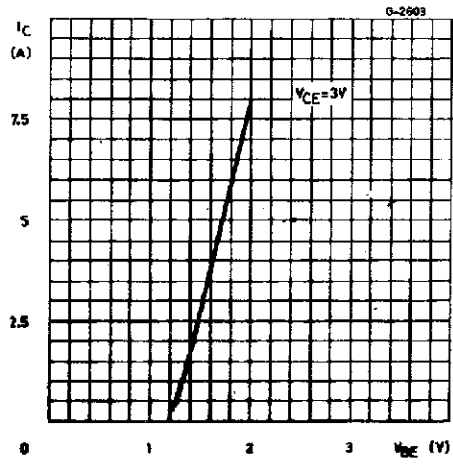

Collector Emitter Saturation Voltage (NPN types)

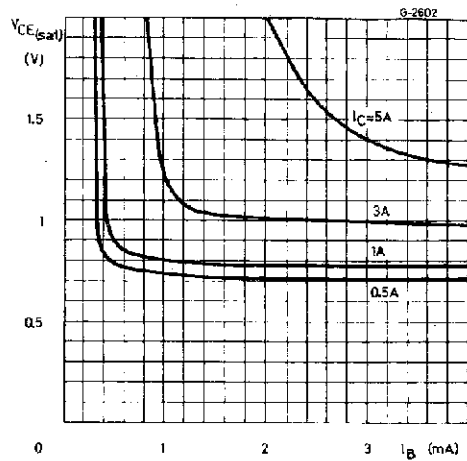

Collector Emitter Saturation Voltage (PNP types)

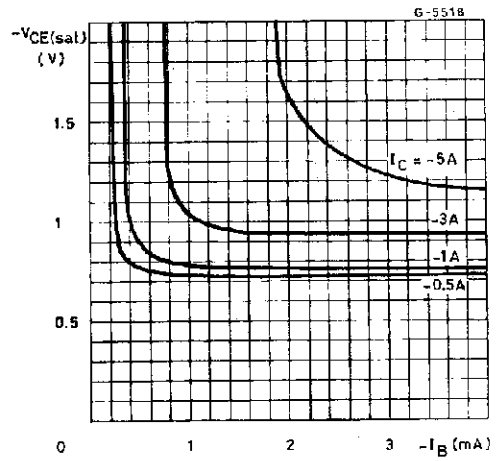

BDW93B/BDW93C/BDW94B/BDW94C

Saturated Switching Characteristics (NPN types)

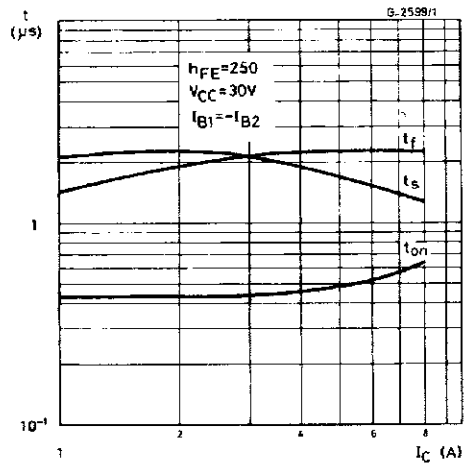

Saturated Switching Characteristics (PNP types)

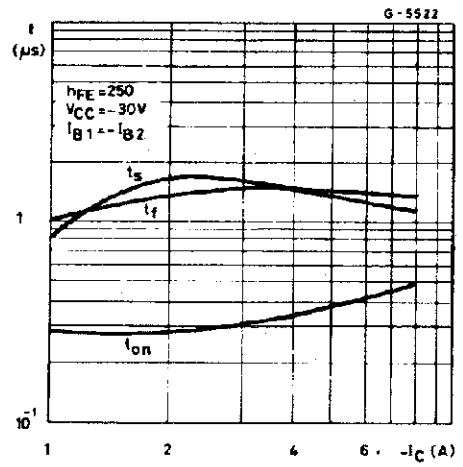

Collector Emitter Saturation Voltage (PNP types)

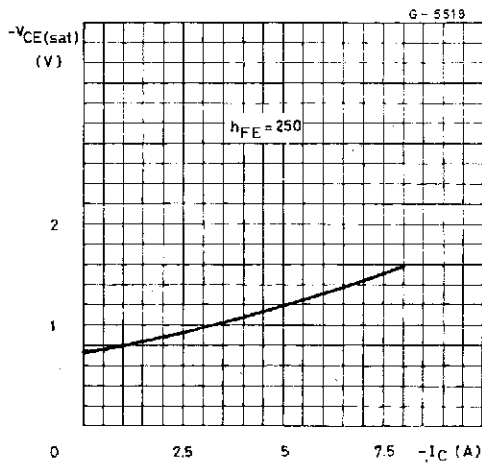

DC Current Gain (PNP types)

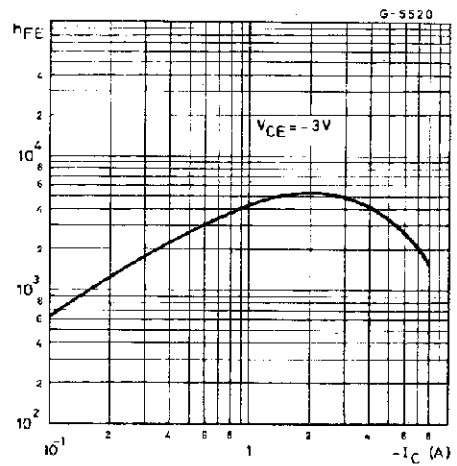

DC Transconductance (PNP types)

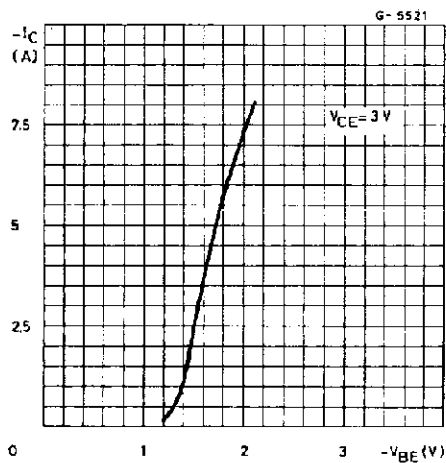

TO-220 MECHANICAL DATA

DIM.	mm			inch		
	MIN.	TYP.	MAX.	MIN.	TYP.	MAX.
A	4.40		4.60	0.173		0.181
C	1.23		1.32	0.048		0.051
D	2.40		2.72	0.094		0.107
D1		1.27			0.050	
E	0.49		0.70	0.019		0.027
F	0.61		0.88	0.024		0.034
F1	1.14		1.70	0.044		0.067
F2	1.14		1.70	0.044		0.067
G	4.95		5.15	0.194		0.203
G1	2.4		2.7	0.094		0.106
H2	10.0		10.40	0.393		0.409
L2		16.4			0.645	
L4	13.0		14.0	0.511		0.551
L5	2.65		2.95	0.104		0.116
L6	15.25		15.75	0.600		0.620
L7	6.2		6.6	0.244		0.260
L9	3.5		3.93	0.137		0.154
DIA.	3.75		3.85	0.147		0.151

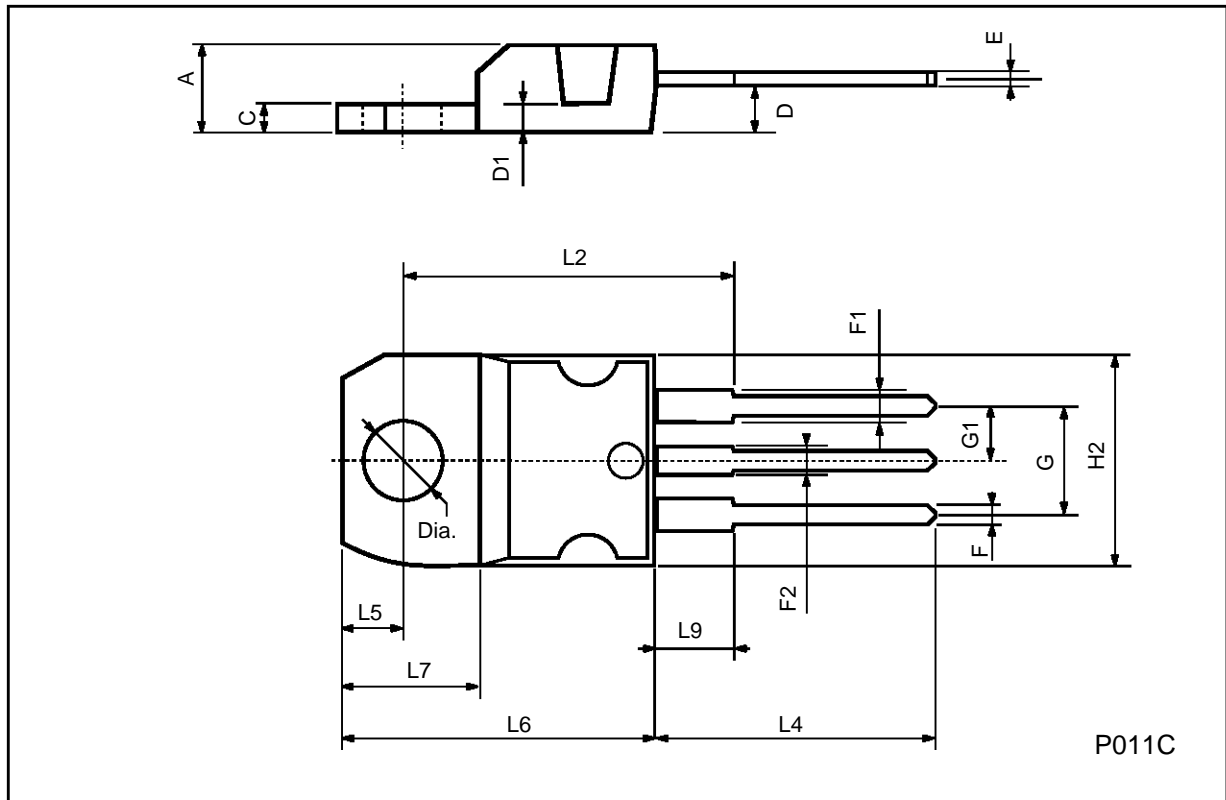

Information furnished is believed to be accurate and reliable. However, SGS-THOMSON Microelectronics assumes no responsibility for the consequences of use of such information nor for any infringement of patents or other rights of third parties which may result from its use. No license is granted by implication or otherwise under any patent or patent rights of SGS-THOMSON Microelectronics. Specifications mentioned in this publication are subject to change without notice. This publication supersedes and replaces all information previously supplied. SGS-THOMSON Microelectronics products are not authorized for use as critical components in life support devices or systems without express written approval of SGS-THOMSON Microelectronics.

© 1997 SGS-THOMSON Microelectronics - Printed in Italy - All Rights Reserved

SGS-THOMSON Microelectronics GROUP OF COMPANIES
Australia - Brazil - Canada - China - France - Germany - Hong Kong - Italy - Japan - Korea - Malaysia - Malta - Morocco - The Netherlands -
Singapore - Spain - Sweden - Switzerland - Taiwan - Thailand - United Kingdom - U.S.A

...