

# ECP052D

½ Watt, High Linearity InGaP HBT Amplifier



## Product Features

- 800 – 1000 MHz
- 18 dB Gain @ 900 MHz
- +28.5 dBm P1dB
- +44 dBm Output IP3
- Single Positive Supply (+5V)
- Lead-free/green/RoHS-compliant 16-pin 4x4mm QFN package

## Applications

- Final stage amplifiers for Repeaters
- Mobile Infrastructure

## Product Description

The ECP052D is a high dynamic range driver amplifier in a low-cost surface mount package. The InGaP/GaAs HBT is able to achieve high performance for various narrowband-tuned application circuits with up to +44 dBm OIP3 and +28.5 dBm of compressed 1dB power. It is housed in an industry standard in a lead-free/green/RoHS-compliant 16-pin 4x4mm QFN surface-mount package. All devices are 100% RF and DC tested.

The ECP052D is targeted for use as a driver amplifier in wireless infrastructure where high linearity and medium power is required. An internal active bias allows the ECP052D to maintain high linearity over temperature and operate directly off a single +5V supply. This combination makes the device an excellent candidate for transceiver line cards in current and next generation multi-carrier 3G base stations.

## Functional Diagram

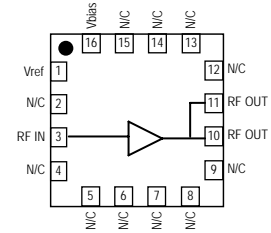

Function	Pin No.
Vref	1
RF Input	3
RF Output	10, 11
Vbias	16
GND	Backside Paddle
N/C or GND	2, 4-9, 12-15

## Specifications

Parameter	Units	Min	Typ	Max
Operational Bandwidth	MHz	800		1000
Test Frequency	MHz		850	
Gain	dB		17	
Output P1dB	dBm		+28	
Output IP3 <sup>(2)</sup>	dBm		+44	
Test Frequency	MHz		900	
Gain	dB	15.5	17.8	
Input Return Loss	dB		18	
Output Return Loss	dB		7	
Output P1dB	dBm	+27	+28.7	
Output IP3 <sup>(2)</sup>	dBm	+42.5	+43	
IS-95A Channel Power @ -45 dBc ACPR, 1960 MHz	dBm		+23	
Noise Figure	dB		7	
Quiescent Current, Icq	mA	200	250	300
Device Voltage, Vcc	V		+5	

1. Test conditions unless otherwise noted: 25 °C, Vsupply = +5 V, in tuned application circuit.

2. 3OIP measured with two tones at an output power of +11 dBm/tone separated by 1 MHz. The suppression on the largest IM3 product is used to calculate the 3OIP using a 2:1 rule.

3. This corresponds to the quiescent current or operating current under small-signal conditions into pins 6, 7, and 8. It is expected that the current can increase by an additional 50 mA at P1dB. Pin 1 is used as a reference voltage for the internal biasing circuitry. It is expected that Pin 1 will pull 12mA of current when used with a series bias resistor of R1=100Ω. (ie. total device current typically will be 262 mA.)

## Absolute Maximum Rating

Parameter	Rating
Storage Temperature	-65 to +150 °C
RF Input Power (continuous)	+22 dBm
Device Voltage	+8 V
Device Current	400 mA
Device Power	2 W
Thermal Resistance, Rth	60°C/W
Junction Temperature	+200°C

Operation of this device above any of these parameters may cause permanent damage.

## Ordering Information

Part No.	Description
ECP052D-G	½-Watt, High Linearity InGaP HBT Amplifier (lead-free/green/RoHS-compliant 16-pin 4x4mm QFN package)
ECP052D-PCB900	900 MHz Evaluation Board

Standard tape / reel size = 1000 pieces on a 7" reel

Specifications and information are subject to change without notice

### Typical Device Data

S-Parameters ( $V_{cc} = +5\text{ V}$ ,  $I_{cc} = 250\text{ mA}$ ,  $T = 25\text{ }^\circ\text{C}$ , unmatched 50 ohm system)

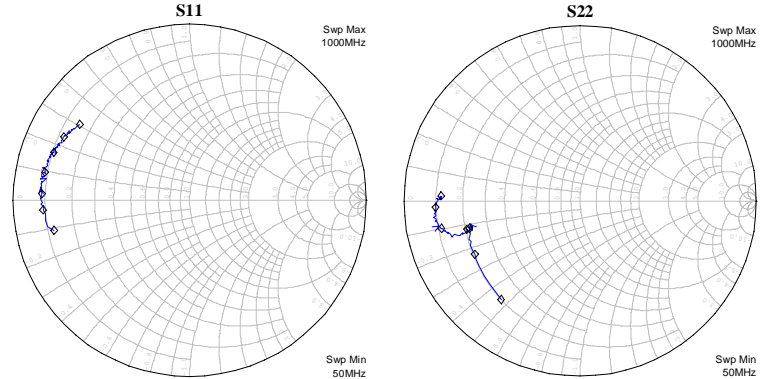
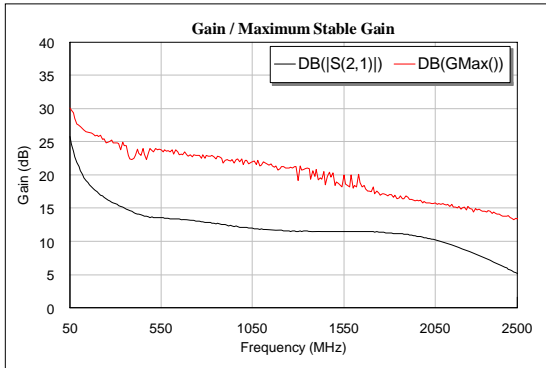

**Notes:**

The gain for the unmatched device in 50 ohm system is shown as the trace in black color. For a tuned circuit for a particular frequency, it is expected that actual gain will be higher, up to the maximum stable gain. The maximum stable gain is shown in the dashed red line. The return loss plots are shown from 50 – 1000 MHz, with markers placed at .05, 0.1 and 0.2 – 1 GHz in 0.2 GHz increments.

S-Parameters ( $V_{cc} = +5\text{ V}$ ,  $I_{cc} = 250\text{ mA}$ ,  $T = 25\text{ }^\circ\text{C}$ , unmatched 50 ohm system, calibrated to device leads)

Freq (MHz)	S11 (dB)	S11 (ang)	S21 (dB)	S21 (ang)	S12 (dB)	S12 (ang)	S22 (dB)	S22 (ang)
50	-2.08	-167.47	25.81	121.88	-34.39	20.06	-2.85	-128.57
100	-1.60	-176.25	21.21	119.02	-33.70	10.30	-3.46	-152.91
200	-1.55	177.39	17.43	119.68	-34.57	-0.55	-3.77	-165.97
400	-1.57	168.97	14.31	113.15	-35.33	-4.58	-3.57	-165.83
600	-1.76	160.42	13.39	106.07	-33.51	-4.12	-1.91	-168.71
800	-1.97	153.20	12.83	91.91	-33.13	-16.00	-1.70	-177.38
1000	-2.43	145.24	12.08	78.04	-30.97	-28.08	-2.05	177.99
1200	-3.12	137.49	11.67	64.05	-30.23	-36.11	-2.30	175.47
1400	-4.43	127.55	11.46	48.41	-30.25	-46.25	-2.36	174.66
1600	-7.08	115.61	11.47	30.39	-29.61	-62.25	-2.41	173.61
1800	-14.24	109.36	11.30	7.39	-28.18	-82.41	-2.06	171.18
2000	-16.59	-142.19	10.56	-17.73	-28.42	-109.55	-1.64	168.93
2200	-7.06	-146.15	8.89	-43.22	-29.33	-134.21	-1.22	162.93
2400	-3.67	-163.93	6.53	-65.55	-30.99	-158.32	-1.18	155.95
2600	-2.10	179.98	3.89	-83.84	-32.78	179.11	-1.43	149.66
2800	-1.47	166.40	1.31	-98.81	-36.21	169.00	-1.39	144.07
3000	-1.06	153.09	-1.27	-112.21	-36.60	140.50	-1.60	138.31

### Application Circuit PC Board Layout

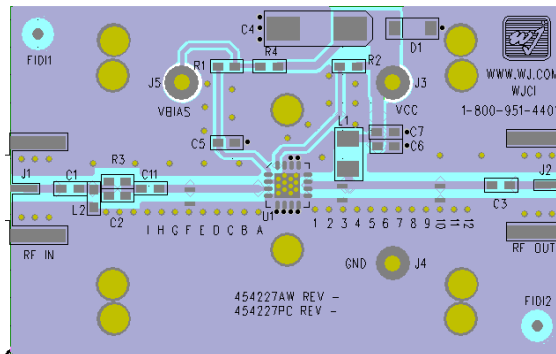

Circuit Board Material: .014" Getek, 4 - layer, 1 oz copper, Microstrip line details: width = .026", spacing = .026"  
 The silk screen markers 'A', 'B', 'C', etc. and '1', '2', '3', etc. are used as placemarkers for the input and output tuning  
 Shunt capacitors – C8, C9 and C10. The markers and vias are spaced in .050" increments.

# ECP052D

½ Watt, High Linearity InGaP HBT Amplifier



## 900 MHz Application Circuit (ECP052D-PCB900)

Typical RF Performance at 25 °C

Frequency	900 MHz
S21 – Gain	17.5 dB
S11 – Input Return Loss	-18 dB
S22 – Output Return Loss	-7 dB
Output P1dB	+28.7 dBm
Output IP3 (+11 dBm / tone, 1 MHz spacing)	+43 dBm
Channel Power (@ -45 dBc ACPR, IS-95 9 channels fwd)	+23 dBm
Noise Figure	7 dB
Device / Supply Voltage	+5 V
Quiescent Current	250 mA

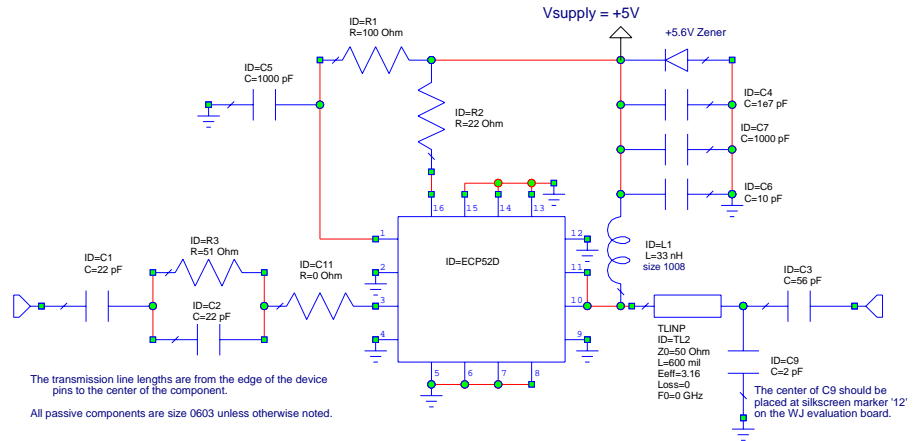

S21 vs Frequency

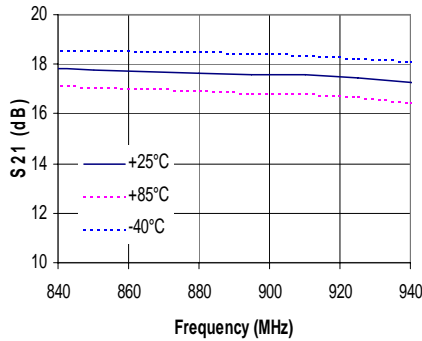

S11 vs. Frequency

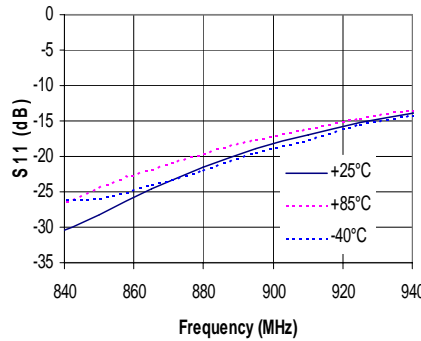

S22 vs. Frequency

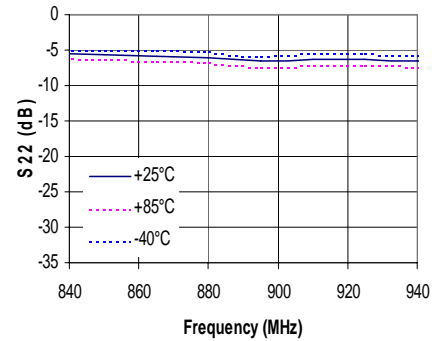

Noise Figure vs. Frequency

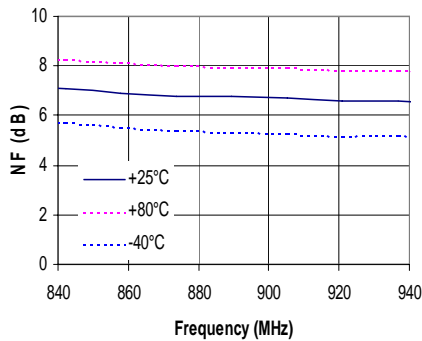

P1 dB vs. Frequency

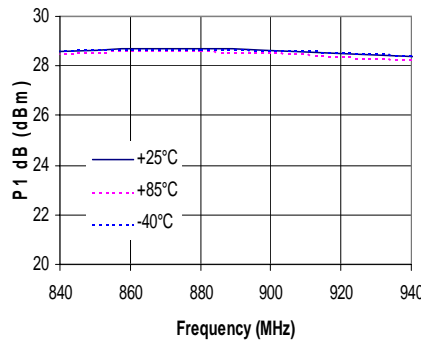

ACPR vs. Channel Power  
IS-95, 9 Ch. Fwd, ±885KHz Meas BW, 900 MHz

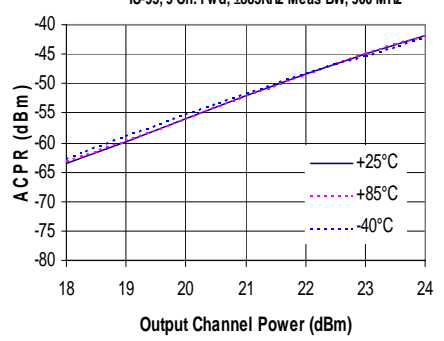

OIP3 vs. Temperature

freq. = 900, 901 MHz, +13 dBm /tone

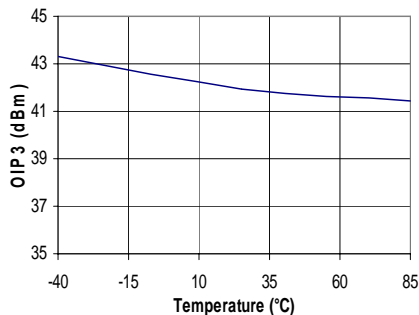

OIP3 vs. Output Power

freq. = 900, 901 MHz, +25°C

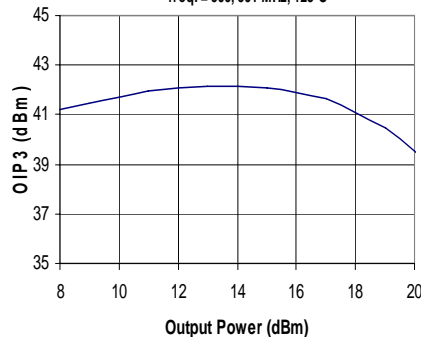

OIP3 vs. Frequency

+25°, +13 dBm /tone

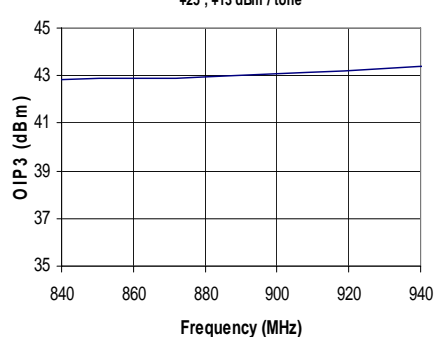

Specifications and information are subject to change without notice

