

Amplifiers With Digital Display Offer Remote Teaching and Easy-to-Repeat Settings

- Large, easy-to-read digital display enables easy setting and real-time monitoring
- Three “Fiber Network Communications Units” enable some E3X-DA models to be used in industrial network communications such as the DeviceNet, CompoBus/S and RS-422
- Wire-saving models have a unique connector design that allows up to 16 amplifiers to be connected
- Hand-held programmer offers “copy and paste” function for easy setting
- Auto Power Control circuit enhances stable detection by maintaining the LED’s light intensity level throughout the sensor’s life
- Dual analog-digital output models and models with two independent digital outputs increase application flexibility
- Available with red, green, blue or infrared light source



Ordering Information:

Important note for ordering:

Choose normally stocked products whenever possible to ensure availability that matches your schedule. Normally stocked items are shown as shaded in the Ordering Information tables. Non-stocked items are available but are subject to longer lead times. For the most up-to-date information on stock status, contact your Omron representative.

■ Amplifier Units With 2 Meter Cables

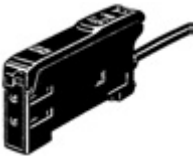
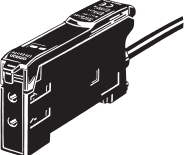
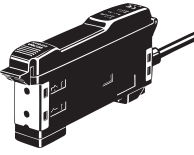
Item	Appearance	Output	Part Number		
			NPN output	PNP output	
Standard models		ON/OFF	E3X-DA11-N	E3X-DA41-N	
Dual analog/digital output models		ON/OFF, Analog	E3X-DA21-N	E3X-DA51-N	
Mark-detecting models		Blue LED	ON/OFF	E3X-DAB11-N	E3X-DAB41-N
		Green LED		E3X-DAG11-N	E3X-DAG41-N
Infrared models		E3X-DAH11-N	E3X-DAH41-N		
Two independent output models			E3X-DA11TW	E3X-DA41TW	
Water-resistant models			E3X-DA11V	E3X-DA41V	

■ Wire-saving Amplifier Units

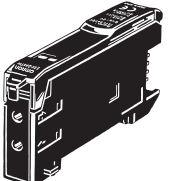
Item		Appearance	Output	Part number				
				NPN output	PNP output	Applicable Connector (order separately)		
Standard models			ON/OFF	E3X-DA6	E3X-DA8	Master	E3X-CN11	
						Slave	E3X-CN12	
						Cordless	E3X-CN02	
Dual analog/digital output models				ON/OFF, Analog	E3X-DA7	E3X-DA9	Master	E3X-CN21
							Slave	E3X-CN22
Mark-detecting models	Blue LED			ON/OFF	E3X-DAB6	E3X-DAB8	Master	E3X-CN11
							Slave	E3X-CN12
							Cordless	E3X-CN02
	Green LED			ON/OFF	E3X-DAG6	E3X-DAG8	Master	E3X-CN11
							Slave	E3X-CN12
		Cordless					E3X-CN02	
Infrared models		ON/OFF		E3X-DAH6	E3X-DAH8	Master	E3X-CN11	
			Slave			E3X-CN12		
Two independent output models		ON/OFF	E3X-DA6TW	E3X-DA8TW	Master	E3X-CN21		
					Slave	E3X-CN22		
					Cordless	E3X-CN02		
Incident light level monitoring model		ON/OFF	E3X-DA6-P	—	Master	E3X-CN11		
					Slave	E3X-CN12		
					Cordless	E3X-CN02		

■ Amplifier Units with M8 Connectors

Item	Appearance	Output	Part number		
			NPN output	PNP output	Applicable connector (order separately)
Standard models		ON/OFF	E3X-DA14V	E3X-DA44V	XS3F-M421-40□-A
					XS3F-M422-40□-A
					XS3W-M421-402-R

■ Fiber Amplifiers for DeviceNet, CompoBus/S, and RS-422 Network Communications

Type	Appearance	Output	Applicable network communications	Fiber Network Communication Unit (Order Separately) (See note 2)	Slave Connector for Fiber Amplifier Unit (See note 3)	Part number	
						NPN	PNP
Wire-saving standard models		ON/OFF	DeviceNet	E3X-DRT21	E3X-CN02	E3X-DA6 (See note 1)	E3X-DA8 (See note 1)
CompoBus/S			E3X-SRT21				
RS-422			E3X-CIF11				
Wire-saving Blue LED models			DeviceNet	E3X-DRT21	E3X-CN02	E3X-DAB6	E3X-DAB8
CompoBus/S			E3X-SRT21				
RS-422			E3X-CIF11				
Wire-saving Green LED models			DeviceNet	E3X-DRT21	E3X-CN02	E3X-DAG6	E3X-DAG8
CompoBus/S			E3X-SRT21				
RS-422			E3X-CIF11				
Light incident level monitoring model	DeviceNet	E3X-DRT21	E3X-CN02	E3X-DA6-P	—		
CompoBus/S	E3X-SRT21						
RS-422	E3X-CIF11						
Two independent output models			DeviceNet	E3X-DRT21	E3X-CN02	E3X-DA6TW	E3X-DA8TW
CompoBus/S			E3X-SRT21				
RS-422			E3X-CIF11				



- Note:**
1. Amplifiers that were manufactured before June 18, 2001 cannot be implemented on DeviceNet, CompoBus/S, and RS-422 network communications.
 2. The E3X-DAN must be attached to the corresponding communication unit, according to the table above, in order for it to be used in DeviceNet, CompoBus/S or RS-422 network communications. Refer to Fiber Network Communications Units data sheet (Cat no. E323-E1-1) for details.
 3. Fiber Amplifier units for Network Communications must be used with slave connectors.

■ Terminal Block Amplifier for DeviceNet, CompoBus/S, and RS-422 Network Communications

Type	Appearance	Applicable network communications	Communication Unit (order separately)	Slave Connector for Fiber Amplifier Unit	Part number
Terminal block (See note)		DeviceNet	E3X-DRT21	E3X-CN02	E39-TM1
CompoBus/S		E3X-SRT21			
RS-422		E3X-CIF11			



- Note:** This unit allows one input from a micro-switch, limit switch or other type of sensor. Connect this unit as far from the Fiber Network Communication Unit as possible.

■ Connectors (Order Separately)





Item	Appearance	Cable length	No. of conductors	Part number	
Master Connector for wire-saving amplifier units		2 m	3	E3X-CN11	
			4	E3X-CN21	
Slave Connector for wire-saving amplifier units		2 m	1	E3X-CN12	
			2	E3X-CN22	
Slave Connector for fiber network communications amplifiers	1-wire cord	—	2 m	1	E3X-CN12
	Cordless	—	—	—	E3X-CN02

Note: Stickers for Connectors are included as accessories.

■ M8 Connectors (Order Separately)

Size	Appearance	Number of conductors	Cable length	Part number
Straight connector, single ended		4	2 m (6.56 ft.)	XS3F-M421-402-A
			5 m (16.41 ft.)	XS3F-M421-405-A
Right angle, single headed connector		4	2 m (6.56 ft.)	XS3F-M422-402-A
			5 m (16.41 ft.)	XS3F-M422-405-A
Straight connector, double ended		4	2 m (6.56 ft.)	XS3W-M421-402-R

■ Remote Control Programmer (Order Separately)

Type	Appearance	Part number
Optical communication head, programmer, cable, AC adapter Power supply method: Chargeable battery		E3X-MC11
Programmer		E3X-MC11-C1
Optical communication head		E3X-MC11-H1
Cable (1.5 m)		E39-Z12-1
Cable (5.0 m)		E39-Z12-2

■ Accessories (Order Separately)

Mounting Brackets

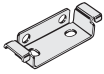
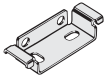
Appearance	Applicable model	Part number	Quantity
	E3X-DA□-N E3X-DA□	E39-L143	1
	E3X-DA□V	E39-L148	1

End Plate

Appearance	Part number	Quantity
	PFP-M	1

Operating Instructions Sticker

Part number	Remarks
E39-Y1	Attach near the sensor.

■ Combining Multiple Wire-saving Amplifiers and Connector Cables

When combining wire-saving amplifiers, the amplifiers that are connected together must all have the same part number. Only one master connector is required. The master connector cable distributes power to all the “ganged” wire-saving amplifiers. The rest of the wire-saving amplifiers require slave connector cables; slave connector cables handle output signal transmission only.

Example: Requirements for combining 6 E3X-DA6 amplifiers together:

- 1 master connector cable
- 5 slave connector cables
- 6 E3X-DA6 amplifiers

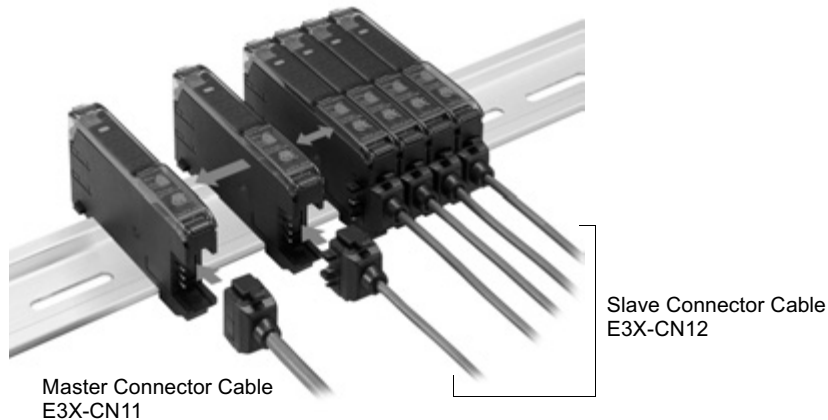

Ordering Information: Fiber-Optic Cables





■ Through-beam Fiber Units



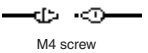

: long-distance mode
 : Standard mode
 : High-speed mode

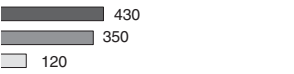
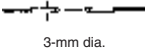
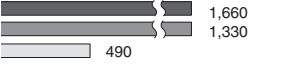
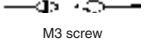
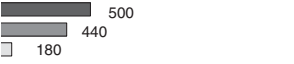
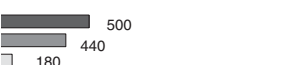
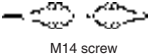
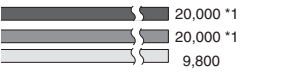
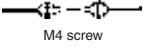
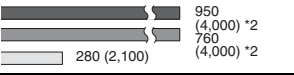
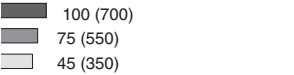
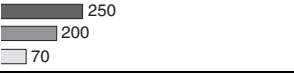
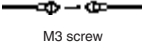
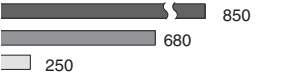
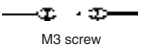



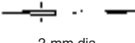
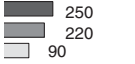
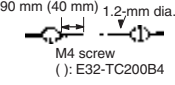
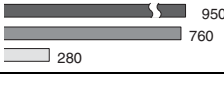
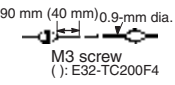
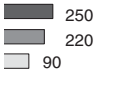
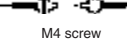
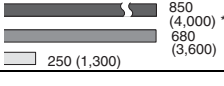
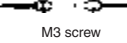
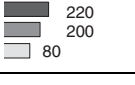
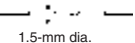
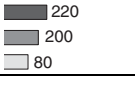
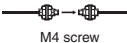
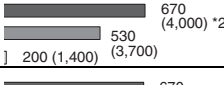
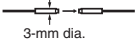
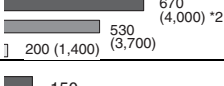
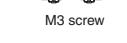
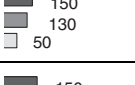
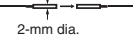
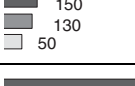
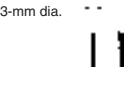
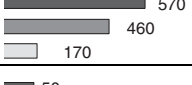
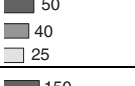
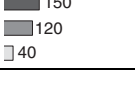
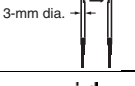
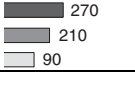
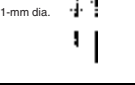
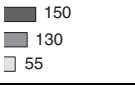

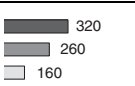
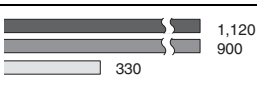

- "Standard object" measurements were made with the E3X-DA-N set to Standard mode. The standard object size is equal to the diameter of the fiber core or the lens diameter on models with a lens.
- "Minimum sensing object" is shown in parentheses below the standard object. The minimum sensing object size was determined when the E3X-DA-N amplifier received light that exceeded a light incident value of 1000 (set to digital incident level display).

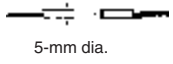

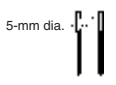
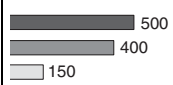
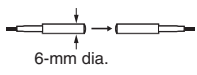
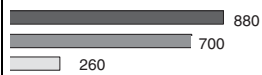
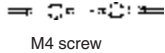
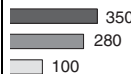
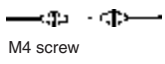
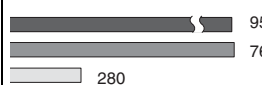
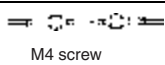
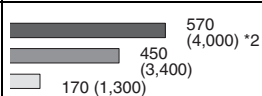
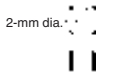
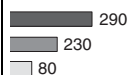

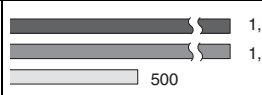
Note: Specifications for the E3X-DA□V and the E3X-DA□TW are similar to the E3X-DA□N and specifications for the E3X-DAG□-N are similar to the E3X-DAB□-N

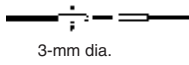
Free-cut Indicates models that customers can cut to length for their application. Models without this mark are pre-cut by the factory to maintain their respective specifications.

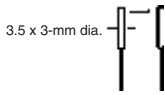
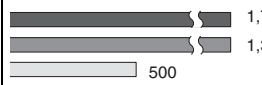
Application	Features	Appearance	Applicable Amplifier Unit	Sensing distance (mm) (Values in parentheses: when using the E39-F1 Lens Unit)	Standard object *3 (min. sensing object: opaque)	Part number	Permissible bending radius
Long distance	M4 Free-cut	 M4 screw	E3X-DA□-N	 1,660 (4,000) 1,330 (3,200) 490 (1,200)	1.4-mm dia. (0.02-mm dia.)	E32-T11L	25 mm
			E3X-DAB11-N	 150 120 75			
			E3X-DAH□-N	 430 350 120			
	3-mm dia. Free-cut	 3-mm dia.	E3X-DA□-N	 1,660 (4,000) 1,330 (3,200) 490 (1,200)	1.4-mm dia. (0.01-mm dia.)	E32-T12L	
	M3 Free-cut	 M3 screw	E3X-DA□-N	 500 440 180	0.9-mm dia. (0.01-mm dia.)	E32-T21L	10 mm
			E3X-DA□-N	 500 440 180		E32-T22L	
M14; with lens; ideal for explosion-proof applications Free-cut	 M14 screw	E3X-DA□-N	 20,000 *1 20,000 *1 9,800	10-mm dia. (0.01-mm dia.)	E32-T17L	25 mm	
General-purpose	M4 Free-cut	 M4 screw	E3X-DA□-N	 950 (4,000) *2 760 (4,000) *2 280 (2,100)	1.0-mm dia. (0.01-mm dia.)	E32-TC200	25 mm
			E3X-DAB11-N	 100 (700) 75 (550) 45 (350)			
			E3X-DAH□-N	 250 200 70			
	M3; possible to mount the reflective side-view conversion attachment E39-F5 Free-cut	 M3 screw	E3X-DA□-N	 850 680 250		E32-TC200A	25 mm
	M3; for detecting minute sensing objects Free-cut	 M3 screw	E3X-DA□-N	 250 220 90	0.5-mm dia. (0.01-mm dia.)	E32-TC200E	10 mm
E3X-DAB11-N	 25 20 10						

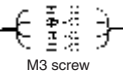
Application	Features	Appearance	Applicable Amplifier Unit	Sensing distance (mm) (Values in parentheses: when using the E39-F1 Lens Unit)	Standard object *3 (min. sensing object: opaque)	Part number	Permissible bending radius
Thin fiber	2-mm dia.; for detecting minute objects (Free-cut)	 2-mm dia.	E3X-DA□-N	 250 220 90	0.5-mm dia. (0.01-mm dia.)	E32-T22	10 mm
	1.2-mm dia.; with sleeve (Free-cut)	90 mm (40 mm) 1.2-mm dia.  M4 screw (): E32-TC200B4	E3X-DA□-N E3X-DAB11-N	 950 760 280 100 75 45	1.0-mm dia. (0.01-mm dia.)	E32-TC200B E32-TC200B4	25 mm
	0.9-mm dia.; with sleeve (Free-cut)	90 mm (40 mm) 0.9-mm dia.  M3 screw (): E32-TC200F4	E3X-DA□-N	 250 220 90	0.5-mm dia. (0.01-mm dia.)	E32-TC200F E32-TC200F4	10 mm
Flexible (resists breaking) (R1-R4)	Ideal for mounting on moving sections (R1-R4) (Free-cut)	 M4 screw	E3X-DA□-N	 850 (4,000) *2 680 (3,600) 250 (1,300)	1.0-mm dia. (0.01-mm dia.)	E32-T11	4 mm
		 M3 screw	E3X-DA□-N	 220 200 80	0.5-mm dia. (0.01-mm dia.)	E32-T21	E32-T22B
		 1.5-mm dia.	E3X-DA□-N	 220 200 80			
	M4 screw (R1) (Free-cut)	 M4 screw	E3X-DA□-N	 670 (4,000) *2 530 (3,700) 200 (1,400)	1.0-mm dia. (0.01-mm)	E32-T11R	1 mm
	3-mm dia. (R1) (Free-cut)	 3-mm dia.	E3X-DA□-N	 670 (4,000) *2 530 (3,700) 200 (1,400)		E32-T12R	
	M3 screw; small diameter (R1) (Free-cut)	 M3 screw	E3X-DA□-N	 150 130 50	0.5-mm dia. (0.01-mm)	E32-T21R	
	2-mm dia.; small diameter (R1) (Free-cut)	 2-mm dia.	E3X-DA□-N	 150 130 50		E32-T22R	
Side-view	Long distance; space-saving (Free-cut)	3-mm dia. 	E3X-DA□-N	 570 460 170	1.0-mm dia. (0.01-mm dia.)	E32-T14L	25 mm
			E3X-DAB11-N	 50 40 25			
			E3X-DAH□-N	 150 120 40			
	Space-saving, flexible (R1) (Free-cut)	3-mm dia. 	E3X-DA□-N	 270 210 90		E32-T14LR	1 mm
	Suitable for detecting minute objects (Free-cut)	1-mm dia. 	E3X-DA□-N	 150 130 55	0.5-mm dia. (0.01-mm dia.)	E32-T24	10 mm
	Suitable for detecting minute objects; small diameter (Free-cut)	1-mm dia. 	E3X-DA□-N	 60 50 25		E32-T24R	1 mm
	Screw-mounting type, long sensing distance (Free-cut)		E3X-DA□-N	 4,000 3,400 1,250	4.0-mm dia. (0.01-mm dia.)	E32-T14	25 mm
E3X-DAB11-N			 320 260 160				
E3X-DAH□-N			 1,120 900 330				

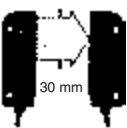
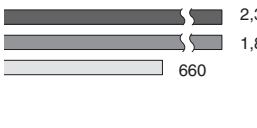
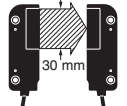
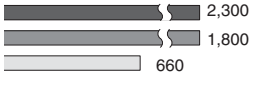
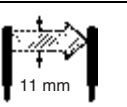
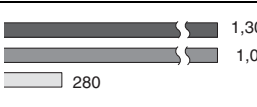
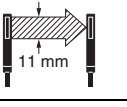
Application	Features	Appearance	Applicable Amplifier Unit	Sensing distance (mm) (Values in parentheses: when using the E39-F1 Lens Unit)	Standard object *3 (min. sensing object: opaque)	Part number	Permissible bending radius
Chemical-resistant	Teflon-covered *4; withstands chemicals and harsh environments (operating ambient temperature: -30°C to 70°C) Free-cut	 5-mm dia.	E3X-DA□-N	 3,800 3,000 1,100	4.0-mm dia. (0.01-mm dia.)	E32-T12F	40 mm
	Teflon covered *4; side-view; withstands chemicals and harsh environments (operating ambient temperature: -30°C to 70°C) Free-cut	 5-mm dia.	E3X-DA□-N	 500 400 150	3.0-mm dia. (0.01-mm dia.)	E32-T14F	
	Teflon *4; withstands chemicals and harsh environments (operating ambient temperature: -40°C to 200°C)	 6-mm dia.	E3X-DA□-N	 880 700 260	1.0-mm dia. (0.01-mm dia.)	E32-T81F	10 mm
Heat-resistant	Resists 200°C; flexible (R10); fiber sheath material: Teflon *4 (operating ambient temperature: -40°C to 200°C)	 M4 screw	E3X-DA□-N	 350 280 100	1.0-mm dia. (0.01-mm dia.)	E32-T81R	10 mm
	Resists 150°C *5; fiber sheath material: fluoresein (operating ambient temperature: -40°C to 150°C) Free-cut	 M4 screw	E3X-DA□-N	 950 760 280	1.5-mm dia. (0.01-mm dia.)	E32-T51	35 mm
	Resists 300°C *6, with spiral tube; high mechanical strength; fiber sheath material: stainless steel (operating ambient temperature: -40°C to 300°C)	 M4 screw	E3X-DA□-N	 570 (4,000) *2 450 (3,400) 170 (1,300)	1.0-mm dia. (0.01-mm dia.)	E32-T61	25 mm
	Side-view; resists 150°C *5; suitable for detecting minute sensing objects; fiber sheath material: fluoresein (operating ambient temperature: -40°C to 150°C) Free-cut	 2-mm dia.	E3X-DA□-N	 290 230 80		E32-T54	35 mm
	Resists 200°C *6; L-shaped; fiber sheath material: stainless steel	 3-mm dia.	E3X-DA□-N	 1,700 1,300 500	1.7-mm dia. (0.01-mm dia.)	E32-T84S	25 mm
Slot Sensor	Suitable for film sheet detection; no optical axis adjustment required; easy to mount Free-cut		E3X-DA□-N		4.0-mm dia. (2.0-mm dia.)	E32-G14	25 mm
			E3X-DAB11-N	 10 10 10			
			E3X-DAH□-N				
Narrow vision field	Suitable for detecting wafers Free-cut	 3-mm dia.	E3X-DA□-N	 2,300 1,900 700	1.7-mm dia. (0.01-mm dia.)	E32-T22S	10 mm
	Side-view; suitable for detecting wafers Free-cut	 3.5 x 3-mm dia.	E3X-DA□-N	 1,700 1,300 500	2.0-mm dia. (0.01-mm dia.)	E32-T24S	

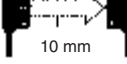
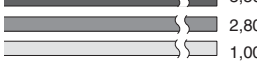
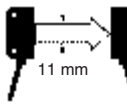
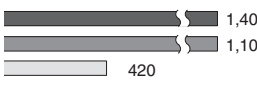
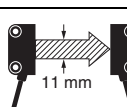
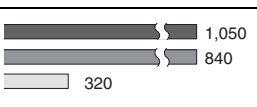
Application	Features	Appearance	Applicable Amplifier Unit	Sensing distance (mm) (Values in parentheses: when using the E39-F1 Lens Unit)	Standard object *3 (min. sensing object: opaque)	Part number	Permissible bending radius
Area sensing	Multi-point detection (4-head)	 M3 screw	E3X-DA□-N		2.0-mm dia. (0.01-mm dia.)	E32-M21	25 mm
	Detects in a 30-mm wide area <small>(Free-cut)</small>	 30 mm	E3X-DA□-N		(0.3-mm dia.) *7	E32-T16W	10 mm
	Detects in a 30-mm wide area, flexible <small>(Free-cut)</small>	 30 mm	E3X-DA□-N			E32-T16WR	1 mm
	Side-view; suitable for applications with limited spatial depth <small>(Free-cut)</small>	 11 mm	E3X-DA□-N		(0.2-mm dia.) *7	E32-T16J	10 mm
	Side-view; suitable for applications with limited spatial depth, flexible <small>(Free-cut)</small>	 11 mm	E3X-DA□-N			E32-T16JR	1 mm
	Suitable for detecting over a 10-mm area; long distance <small>(Free-cut)</small>	 10 mm	E3X-DA□-N		(0.6-mm dia.) *8	E32-T16	25 mm
	Suitable for detecting minute sensing objects in a wide area; degree of protection: IEC60529 IP50 <small>(Free-cut)</small>	 11 mm	E3X-DA□-N		(0.2-mm dia.) *7	E32-T16P	10 mm
	Suitable for detecting minute sensing objects in a wide area; degree of protection: IEC60529 IP50, flexible <small>(Free-cut)</small>	 11 mm	E3X-DA□-N			E32-T16PR	1 mm

*1The E32-T17L allows a longer sensing distance because its optical fiber length is 10 m.

*2These models allow a longer sensing distance because their optical fiber length is 2 m.

*3Indicates values for standard mode.

*4Teflon is a registered trademark of the Dupont Company and the Mitsui Dupont Chemical Company for their fluoride resin.

*5For continuous operation, use the products within a temperature range of -40°C to 130°C.

*6Indicates the heat-resistant temperature at the fiber tip.

*7These figures are for a sensing distance of 300 mm. (Figures for the diameter of sensing objects are in the still state.)

*8These figures are ones for which detection is possible in each sensing area at a digital incident level of 1,000. (Figures for the diameter of sensing objects are in the still state.)

- Note:**
1. The size of standard sensing object is the same as the fiber core diameter (lens diameter for models with lens).
 2. The values of the minimum sensing object for the through-beam models indicate those obtained where the models are set to receive light when the digital incident level exceeds 1,000 (set to digital incident level display).
 3. Greater freedom with wiring at no loss in light intensity enabled by a comprehensive lineup of flexible fiber models (permissible bending radius: 1 mm). Refer to the following illustration.

Flexible fiber models are indicated by an "R" at the end of the model number.

Flexible fiber contains multiple cores. These cores are all surrounded by cladding, giving a minimum bending radius of 1 mm. The fiber can be bent at right angles without affecting the light intensity. Handle it just like any other cable.

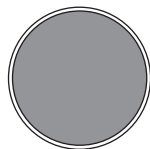

Conventional Fiber

Conventional fiber uses just one core and one cladding section. Bending the fiber beyond the recommended radius may break it or reduce the light intensity.

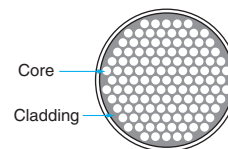

Flexible Fiber



Flexible fiber contains multiple independent cores all surrounded by cladding. The fiber can be bent without breaking or reducing the light intensity.













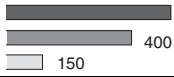



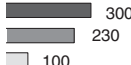









■ Diffuse Fiber Optic Cables

- “Standard object” measurements were made with E3X-DA-N set to Standard Mode.
- “Minimum sensing object” is shown in parentheses below the standard object. The values of the minimum sensing object were obtained at a distance where the smallest object (gold wire) can be sensed with the Diffuse Fiber Unit.
- The E3X-DA-N may continue to receive internal reflective light when it is set to the maximum sensitivity setting. In this case set the amplifier to “two-point teaching with or without-object teaching”.



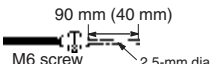
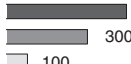

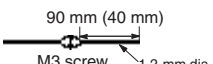





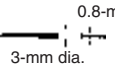

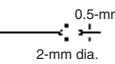



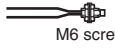

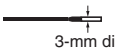

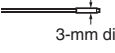

Note: Specifications for the E3X-DA□V and E3X-DA□TW are similar to the E3X-DA□-Ns and the specifications for the E3X-DAG□-N are similar to the E3X-DAB□-Ns.

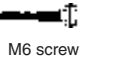

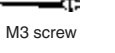

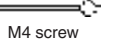

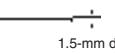



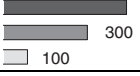
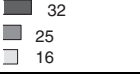

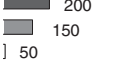

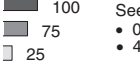

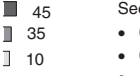
 Indicates models that customers can cut to length for their application. Models without this mark are pre-cut by the factory to maintain their respective specifications.

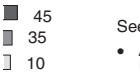

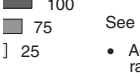

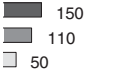
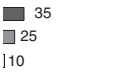

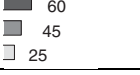
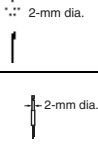
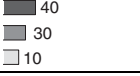
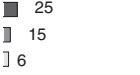

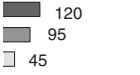



 : Long-distance mode  : Standard mode  : High-speed mode

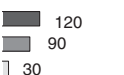
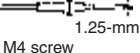
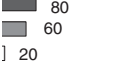

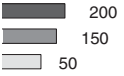

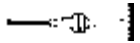
Application	Features	Appearance	Applicable Amplifier Unit	Sensing distance (mm) *1	Standard object (min. sensing object *2: Gold wire)	Part number	Permissible bending radius
Long distance	M6 	 M6 screw	E3X-DA□-N	 500 400 150	500×500 (0.01-mm dia.)	E32-D11L	25 mm
			E3X-DAB11-N (See note)	 44 35 22	100×100 (0.1-mm dia.)		
			E3X-DAH□-N	 130 100 30	200×200 (0.01-mm dia.)		
	3-mm dia.; small diameter 	 3-mm dia.	E3X-DA□-N	 300 230 100	300×300 (0.01-mm dia.)	E32-D12	
	M4 	 M4 screw	E3X-DA□-N	 160 130 45	200×200 (0.01-mm dia.)	E32-D21L	10 mm
3-mm dia.; small diameter 	 3-mm dia.	E3X-DA□-N	 160 130 45		E32-D22L		
General-purpose	M6 	 M6 screw	E3X-DA□-N	 400 300 100	400×400 (0.01-mm dia.)	E32-DC200	25 mm
			E3X-DAB11-N (See note)	 32 25 16	100×100 (0.1-mm dia.)		
			E3X-DAH□-N	 100 75 25	100×100 (0.01-mm dia.)		
	M3; small diameter 	 M3 screw	E3X-DA□-N	 100 80 30	100×100 (0.01-mm dia.)	E32-DC200E	10 mm
	E3X-DAB11-N (See note)	 8 6 4	25×25 (0.2-mm dia.)				
Thin fiber	2.5-mm dia.; with sleeve 	 90 mm (40 mm) M6 screw (): E32-DC200B4 2.5-mm dia.	E3X-DA□-N	 400 300 100	400×400 (0.01-mm dia.)	E32-DC200B E32-DC200B4	25 mm
			E3X-DAB11-N	 32 25 16	100×100 (0.1-mm dia.)		
	1.2-mm dia.; with sleeve 	 90 mm (40 mm) M3 screw (): E32-DC200F4 1.2-mm dia.	E3X-DA□-N (See note)	 100 80 30	100×100 (0.01-mm dia.)	E32-DC200F E32-DC200F4	10 mm

Note: For this color mark amplifier with blue LED light source, only minimum object size is provided.

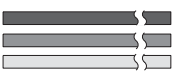
Application	Features	Appearance	Applicable Amplifier Unit	Sensing distance (mm) *1	Standard object (min. sensing object *2: Gold wire)	Part number	Permissible bending radius
Thin fiber	0.8-mm dia.; for detecting minute objects 	 0.8-mm dia. 3-mm dia.	E3X-DA□-N	 ■ 21 ■ 16] 6	25×25 (0.01-mm dia.)	E32-D33	4 mm
		 0.5-mm dia. 2-mm dia.	E3X-DA□-N	 ■ 4] 3] 1		E32-D331	
Flexible (resists breaking) (R1-R4)	Ideal for mounting on moving sections (R1-R4)   	 M6 screw	E3X-DA□-N	 ■ 220 ■ 170 ■ 80	300×300 (0.01-mm dia.)	E32-D11R	1 mm
		 3-mm dia.	E3X-DA□-N	 ■ 220 ■ 170 ■ 80		E32-D12R	
		 M3 screw	E3X-DA□-N	 ■ 40 ■ 30] 10	50×50 (0.01-mm dia.)	E32-D21R	1 mm
		 3-mm dia.	E3X-DA□-N	 ■ 40 ■ 30] 10		E32-D22R	
		 M6 screw	E3X-DA□-N	 ■ 220 ■ 170 ■ 80	300×300 (0.01-mm dia.)	E32-D11	4 mm
		 M3 screw	E3X-DA□-N	 ■ 40 ■ 30] 10	50×50 (0.01-mm dia.)	E32-D21	
		 M4 screw	E3X-DA□-N	 ■ 90 ■ 70 ■ 25	100×100 (0.01-mm dia.)	E32-D21B	
		 1.5-mm dia.	E3X-DA□-N	 ■ 40 ■ 30] 10	50×50 (0.01-mm dia.)	E32-D22B	

Application	Features	Appearance	Applicable Amplifier Unit	Sensing distance (mm) *1	Standard object (min. sensing object *2: Gold wire)	Part number	Permissible bending radius
Coaxial	M6 coaxial; high-precision positioning Free-cut	 M6 screw	E3X-DA□-N	 400 300 100	500×500 (0.01-mm dia.)	E32-CC200	25 mm
			E3X-DAB11-N	 32 25 16	100×100 (0.1-mm dia.)		
			E3X-DAH□-N	 100 75 25	100×100 (0.01-mm dia.)		
	3-mm dia.; small diameter; coaxial; high-precision positioning Free-cut	 3-mm dia.	E3X-DA□-N	 200 150] 50	300×300 (0.01-mm dia.)	E32-D32L	
	M3 coaxial; high-precision positioning; Possible to mount small spot lens (E39-F3A-5, F3B, F3C) Free-cut	 M3 screw	E3X-DA□-N	 100 75] 25	100×100 (0.01-mm dia.)	E32-C31	
	M3 coaxial; high-precision positioning; Possible to mount small spot lens (E39-F3A-5, F3B, F3C)	 M3 screw	E3X-DA□-N	 45 35] 10	50×50 (0.01-mm dia.)		
2-mm dia. coaxial; high-precision positioning; Possible to mount small spot lens (E39-F3A)	 2-mm dia.	E3X-DA□-N	 45 35] 10	See Spot Diameter • Adjustable in the range 0.1 to 0.6-mm dia.		E32-C42	
2-mm dia. coaxial; high-precision positioning; Possible to mount small spot lens (E39-F3A)	 2-mm dia.	E3X-DA□-N	 100 75] 25	See Spot Diameter • Adjustable in the range 0.5 to 1.0-mm dia.	100×100 (0.01-mm dia.)	E32-D32	
Side-view	6-mm dia.; long distance Free-cut	 6-mm dia.	E3X-DA□-N	 150 110] 50	200×200 (0.01-mm dia.)	E32-D14L	25 mm
			E3X-DAH□-N	 35 25] 10	50×50 (0.01-mm dia.)		
	6-mm dia.; flexible Free-cut	 6-mm dia.	E3X-DA□-N	 60 45] 25	100×100 (0.01-mm dia.)	E32-D14LR	1 mm
	2-mm dia.; small diameter space-saving; flexible Free-cut	 2-mm dia.	E3X-DA□-N	 40 30] 10	50×50 (0.01-mm dia.)	E32-D24	10 mm
E3X-DA□-N			 25 15] 6		E32-D24R	1 mm	
Chemical-resistant	Teflon-covered *4; withstands chemicals and harsh environments (operating ambient temperature: -30°C to 70°C) Free-cut	 6-mm dia.	E3X-DA□-N	 120 95] 45	200×200 (0.01-mm dia.)	E32-D12F	40 mm

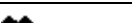
Application	Features	Appearance	Applicable Amplifier Unit	Sensing distance (mm) *1	Standard object (min. sensing object *2: Gold wire)	Part number	Permissible bending radius
Heat-resistant	Resists 150°C *3;  fiber sheath material: fluororesin (operating ambient temperature: -40°C to 150°C)	 M6 screw	E3X-DA□-N	 300 230 100	200×200 (0.01-mm dia.)	E32-D51	35 mm
	Resists 300°C *5; fiber sheath material: stainless steel (operating ambient temperature: -40°C to 300°C)	 M6 screw	E3X-DA□-N	 120 90 30		E32-D61	25 mm
	Resists 400°C *5; fiber sheath material: stainless steel (operating ambient temperature: -40°C to 400°C)	 M4 screw 1.25-mm dia.	E3X-DA□-N	 80 60 20		100×100 (0.01-mm dia.)	E32-D73
Area sensing	Side-view;  detection over wide areas		E3X-DA□-N	 200 150 50	300×300 (0.01-mm dia.)	E32-D36P1	25 mm
Retro-reflective	Transparent object detection; polarized 	 M6 screw Reflector E39-R3	E3X-DA□-N	 10 to 250 10 to 250 10 to 250	35-mm dia. (0.1-mm dia.)	E32-R21 + E39-R3 reflector (included)	10 mm
	Transparent object detection (operating ambient temperature: -25°C to 55°C); degree of protection: IEC60529 IP66; polarized 	 Reflector E39-R1	E3X-DA□-N	 150 to 1,500	35-mm dia. (0.2-mm dia.)	E32-R16 + E39-R1 reflector (included)	25 mm

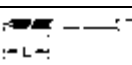
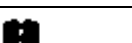
Application	Features	Appearance	Applicable Amplifier Unit	Sensing distance (mm) *1	Standard object (min. sensing object *2: Gold wire)	Part number	Permissible bending radius
Limited reflective	Suitable for positioning crystal glass (Free-cut)		E3X-DA□-N	4 to 12	100×100 Soda glass with reflection factor	E32-L56E1 E32-L56E2	35 mm
	Detects wafers and small differences in height; (operating ambient temperature: -40°C to 105°C); degree of protection: IEC60529 IP50 (Free-cut)		E3X-DA□-N	4±2 4±2 4±2	25×25 (0.01-mm dia.)	E32-L24L E32-L25L	10 mm
			E3X-DA□-N	7.2±1.8 7.2±1.8 7.2±1.8			
	Detects wafers and small differences in height; degree of protection: IEC60529 IP50 (Free-cut)		E3X-DA□-N	3.3 3.3 3.3	25×25 (0.01-mm dia.)	E32-L25 E32-L25A	25 mm
			E3X-DA□-N	3.3 3.3 3.3			
Fluid-level detection	Fluid contact type: unbendable section L 150 mm, 350 mm (two types)		E3X-DA□-N	---	Pure water at 25°C	E32-D82F1 E32-D82F2	40 mm
	Tube-mounting type (Free-cut)		E3X-DA□-N	---	Fluid	E32-L25T	10 mm

*1Sensing distance indicates values for white paper.

*2Indicates values for standard mode.

*3For continuous operation, use the products within a temperature range of -40°C to 130°C.

*4Teflon is a registered trademark of the Dupont Company and the Mitsui Dupont Chemical Company for their fluoride resin.

*5Indicates the heat-resistant temperature at the fiber tip.

Note: The values of the minimum sensing object indicate those obtained at a distance where the smallest object can be sensed with the Reflective Fiber Unit.

When set to the maximum sensitivity setting for the internal reflective light, incident light may continue to be received. In such case, use "two-point teaching with or without-object teaching".

■ Spot Diameter

Use with optional lens units (order separately)

Amplifier unit	Diffuse fiber	Small spot lens	Spot diameter
E3X-DA□-N	E32-C31	E39-F3A-5	0.5 mm dia
		E39-F3B	
		E39-F3C	4.0 mm dia. max.
	E32-C41	E39-F3A-5	0.1 mm dia.
		E39-F3B	0.2 mm dia.
		E39-F3C	4.0 mm dia max
	E32-C42	E39-F3A	Adjustable in the range 0.1 mm to 0.6 mm dia.
	E32-D32	E39-F3A	Adjustable in the range 0.5 mm to 1.0 mm dia.

Specifications: Amplifier Units

■ Amplifier Units with Cables

Item		Standard models	Analog-output models	Mark-detecting models		Infrared models	Water-resistant models	Two independent output models	
Output type	NPN	E3X-DA11-N	E3X-DA21-N	E3X-DAB11-N	E3X-DAG11-N	E3X-DAH11-N	E3X-DA11V	E3X-DA11TW	
	PNP	E3X-DA41-N	E3X-DA51-N	E3X-DAB41-N	E3X-DAG41-N	E3X-DAH41-N	E3X-DA41V	E3X-DA41TW	
Light source (wavelength)		Red LED (660 nm)		Blue LED (470 nm)	Green LED (525 nm)	Infrared LED (870 nm)	Red LED (660 nm)		
Supply voltage		12 to 24 VDC \pm 10%, ripple (p-p) 10% max.							
Power consumption	Normal	960 mW max. (current consumption: 40 mA max. at power supply voltage of 24 VDC)							
	Economy	720 mW max. (current consumption: 30 mA max. at power supply voltage of 24 VDC)							
	Digital display not lit	600 mW max. (current consumption: 25 mA max. at power supply voltage of 24 VDC)							
Control output	ON/OFF	NPN/PNP (depends on model) open collector; load current: 50 mA max.; residual voltage: 1 V max.; Light ON/Dark ON mode selector							
	Analog	---	Load 1 to 5 VDC, 10 k Ω min.	---					
Circuit protection		Reverse polarity, output short-circuit, mutual interference prevention (supported for up to 10 Units)							
Response time	High speed	250 μ s for operation and reset						0.5 ms for operation and reset	
	Standard	1 ms for operation and reset						2 ms for operation and reset	
	Long distance	4 ms for operation and reset						7 ms for operation and reset	
Sensitivity setting		Teaching or manual method							
Functions	Timer function	OFF-delay timer: 0 to 200 ms, 1 to 20 ms (set in 1 ms increments); 20 to 200 ms (set in 5 ms increments)							
	Automatic power control (APC)	Fiber-optic current digital control				---			Fiber-optic current digital control
	Zero-reset	Display can be reset to zero when required (negative values can be displayed).							
	Initial reset	Settings can be returned to defaults as required.							
	Monitor focus	---	Upper and lower limits can be set as required for every 100 digital values.		---				
Display		Operation indicator (orange), 7-segment digital incident level display (red), 7-segment digital incident level percentage display (red), threshold and excess gain 2-color indication bar (green and red), 7-segment digital threshold display (red)							
Display timing		Normal/peak-hold/bottom-hold program selectable							
Display orientation		Normal/reverse program selectable							
Optical axis adjustment		Optical axis adjustment possible (flashing function)							
Ambient illumination (receiver side)		Incandescent lamp: 10,000 lux max. Sunlight: 20,000 lux max.							
Ambient temperature	Operating	1 to 3 Amplifiers: -25°C to 55°C (-13°F to 131°F) 4 to 11 Amplifiers: -25°C to 50°C (-13°F to 122°F) 12 to 16 Amplifiers: -25°C to 45°C (-13°F to 113°F) (with no icing or condensation)							
	Storage	-30°C to 70°C (-22°F to 158°F) with no icing or condensation							
Ambient humidity		Operating and storage: 35% to 85% (with no condensation)							
Insulation resistance		20 M Ω min. (at 500 VDC)							
Dielectric strength (destruction)		1,000 VAC at 50/60 Hz for 1 minute							

Item		Standard models	Analog-output models	Mark-detecting models		Infrared models	Water-resistant models	Two independent output models	
Output type	NPN	E3X-DA11-N	E3X-DA21-N	E3X-DAB11-N	E3X-DAG11-N	E3X-DAH11-N	E3X-DA11V	E3X-DA11TW	
	PNP	E3X-DA41-N	E3X-DA51-N	E3X-DAB41-N	E3X-DAG41-N	E3X-DAH41-N	E3X-DA41V	E3X-DA41TW	
Vibration resistance (destruction)		10 to 55 Hz with a 1.5-mm double amplitude for 2 hrs each in X, Y and Z directions							
Shock resistance (destruction)		500 m/s ² , for 3 times each in X, Y and Z directions							
Enclosure rating		IEC 60529 IP50 (with Protective Cover attached)					IEC 60529 IP66 (with Protective Cover attached)	IEC 60529 IP50 (with Protective Cover attached)	
Connection method		Pre-wired standard cable length: 2 m (6.56 ft.)							
Weight (packed)		Approx. 100 g					Approx. 110 g	Approx. 100 g	
Material	Case	Polybutylene terephthalate (PBT)							
	Cover	Polycarbonate					Polyethersulfone	Polycarbonate	

■ Amplifier Units with Connectors

Specifications for Amplifier Units with Connectors are similar to those for the amplifiers units with 2 meter cables

Item		Standard models	Analog output models	Mark-detecting models		Infrared models	Water-resistant models (See note.)	Two independent output models	
Output type	NPN	E3X-DA6(P)	E3X-DA7	E3X-DAB6	E3X-DAG6	E3X-DAH6	E3X-DA14V	E3X-DA6TW	
	PNP	E3X-DA8	E3X-DA9	E3X-DAB8	E3X-DAG8	E3X-DAH8	E3X-DA44V	E3X-DA8TW	
Connection method		Standard connector cable					M8 connector	Standard connector cable	
Weight (packed)		Approx. 55 g					Approx. 65 g	Approx. 55 g	

Note: The dielectric strength for water-resistant models is 500 VAC at 50/60 Hz for 1 minute.

■ E39-TM1 Specifications

Item		E39-TM1
Supply voltage (See note 1)		12 to 24 VDC ±10%, ripple (p-p) 10% max.
Sensor power supply		11 to 23 VDC (supply voltage -1 VDC)
Current consumption		40 mA max. + sensor current consumption (total: 100 mA max.)
Response time		1.2 ms max.
Number of inputs		1 point
Input signals		NPN/PNP, no voltage input (Contact and non-contact), Switch selectable
Input operating configuration		N.O./N.C., switch selectable
Indicators		Input signal display (orange)
Ambient Temperature (See note 2)	Operating	1 to 3 units: -25°C to 55°C (-13°F to 131°F) 4 to 8 units: -25°C to 45°C (-13°F to 113°F) 9 to 16 units: -25°C to 40°C (-13°F to 104°F) No icing or condensation
	Storage	-30°C to 70°C (-22°F to 158°F)

■ Connectors for Wiring-saving Amplifier Units

Item	E3X-CN11/21/22	E3X-CN12	E3X-CN02
Rated current	2.5 A		
Rated voltage	50 V		
Contact resistance	20 mΩ max. (20 mVDC max., 100 mA max.) (See note 1.)		
No. of insertions	50 times (See note 2.)		
Material	Housing	Polybutylene terephthalate (PBT)	
	Contacts	Phosphor bronze/gold-plated nickel	
Weight (packed)	Approx. 55 g	Approx. 25 g	

- Note:**
1. The specified value for the contact resistance pertains to the contact resistance between the connector and the amplifier unit, and the Connector and other neighboring connectors. It does not include the conductor resistance of the cable.
 2. The specified value represents the number of insertions into the amplifier unit, and the adjacent connector.

■ M8 Connectors

Item	XS3F-M4□□-□□□-A
Current rating	1A
Voltage rating	125 VDC
Contact resistance	40 mΩ max. 20 mVDC max., 100 mA max.
Insulation resistance	1000 mΩ max. 500 mVDC
Dielectric strength	1000 VAC for 1 minute, Leakage current: 1 mA max.
Enclosure rating	IEC IP67
Insertion tolerance	200 times minimum
Tensile strength	50 N (5.1 kgf/15 sec.)
Ambient operating temperature	-25°C to 70°C (-13°F to 158°F)

■ Mobile Console

Item	E3X-MC11
Supply voltage	Charged with AC adapter
Connection method	Connected via adapter
Weight (packed)	Approx. 580 g (Console only: 120 g)

Output Circuits

Refer to the end of the following table for notes and precautions.

Output	Model	Mode selector	Timing chart	State of output transistor	Output circuit
NPN	E3X-DA11-N E3X-DAB11-N E3X-DAG11-N E3X-DAH11-N E3X-DA11V E3X-DA6 E3X-DA6P E3X-DAB6 E3X-DAG6 E3X-DAH6 E3X-DA14V	LIGHT ON (L/ON)		Light ON	
		DARK ON (D/ON)		Dark ON	<p>Connector Pin Arrangement</p> <p>Note: Pin 2 is not used.</p>
E3X-DA21-N E3X-DA7		LIGHT ON (L/ON)		Light ON	
		DARK ON (D/ON)		Dark ON	<p>Note: Load resistance: 10 kΩ min.</p>
E3X-DA11TW E3X-DA6TW		LIGHT ON (L/ON)	<p>CH1/ Incident light CH2 No incident light</p>	Light ON	
		DARK ON (D/ON)	<p>CH1/ Incident light CH2 No incident light</p>	Dark ON	

Output	Model	Mode selector	Timing chart	State of output transistor	Output circuit
PNP	E3X-DA41-N E3X-DAB41-N E3X-DAG41-N E3X-DAH41-N E3X-DA41V E3X-DA8 E3X-DAB8 E3X-DAG8 E3X-DAH8 E3X-DA44V	LIGHT ON (L/ON)		Light ON	<p>Connector Pin Arrangement</p> <p>Note: Pin 2 is not used.</p>
		DARK ON (D/ON)		Dark ON	
E3X-DA51-N E3X-DA9		LIGHT ON (L/ON)		Light ON	<p>Note: Load resistance: 10 kΩ min.</p>
		DARK ON (D/ON)		Dark ON	
E3X-DA41TW E3X-DA8TW		LIGHT ON (L/ON)		Light ON	
		DARK ON (D/ON)		Dark ON	

Note: With E3X-DA□TW models, only channel 1 is output when set for area sensing operation.

LIGHT ON: ON when the incident level is between the thresholds for channels 1 and 2.

DARK ON: OFF when the incident level is between the thresholds for channels 1 and 2. (Channel 2 is always OFF.)

Connectors (Sensor I/O Connectors)

■ Single Ended

**XS3F-M421-402-A,
XS3F-M421-405-A,
XS3F-M422-402-A,
XS3F-M422-405-A**

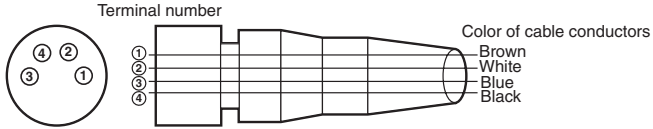

■ Double Ended

XS3W-M421-402-R

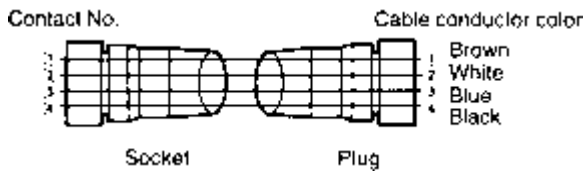

Classification	Color of cable conductors	Connection pin number	Application
DC	Brown	1	Power supply (+V)
	White	2	---
	Blue	3	Power supply (0 V)
	Black	4	Output

Note: Pin 2 is not used.

Engineering Data (Typical)

■ E3X-DA□-N/E3X-DA□V/E3X-DA□TW

Parallel Operating Range

At max. sensitivity. (Use for optical axis adjustment at installation.)

**E32-TC200
(Through-beam)**

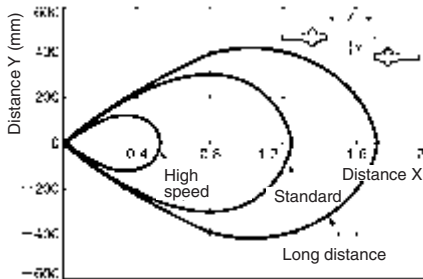

**E32-T11R
(Through-beam)**

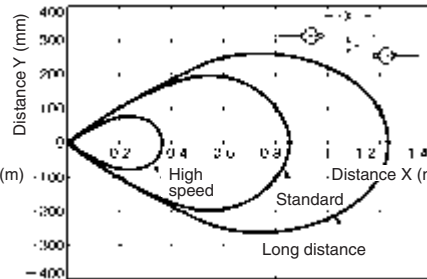

**E32-T11
(Through-beam)**

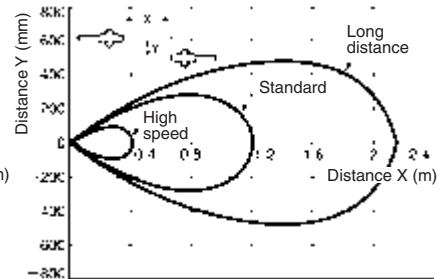

Operating Range

With standard sensing object at max. sensitivity. (Use for the positioning of the object and Sensor.)

**E32-DC200
(Reflective)**

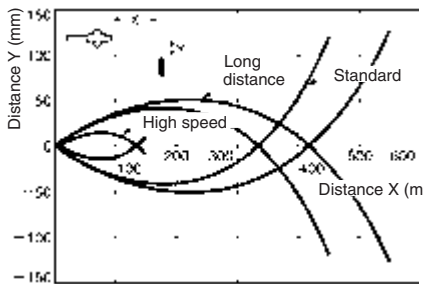

**E32-D33
(Reflective)**

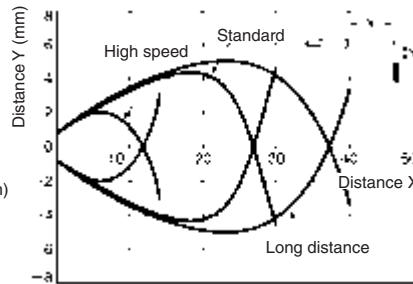

**E32-L25L
(Limited Reflective)**

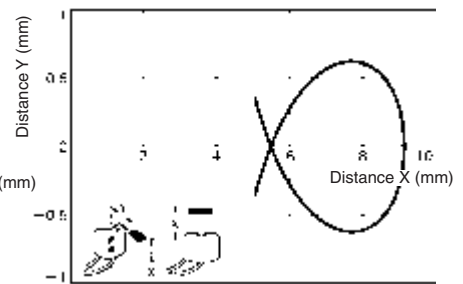

Excess Gain Ratio vs. Distance

With standard sensing object. At max. sensitivity.

**E32-TC200
(Through-beam)**

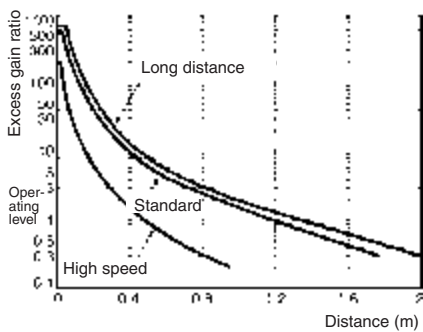

**E32-DC200
(Reflective)**

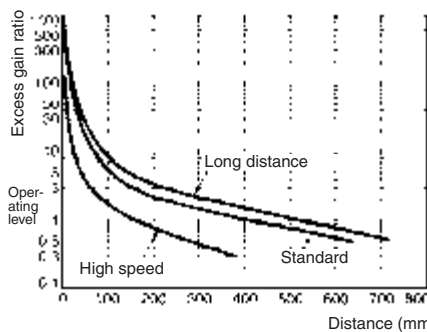

**E32-D21L
(Reflective)**

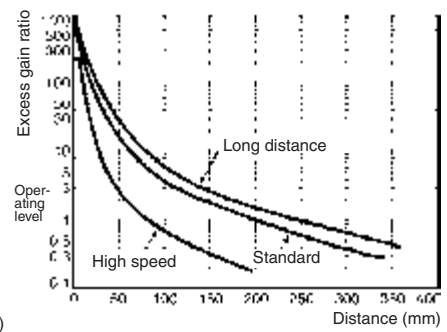

■ E3X-DA□-N/E3X-DA□-V/E3X-DA□-TW

Sensing Distance vs. Operating Range
E32-DC200 (Reflective)

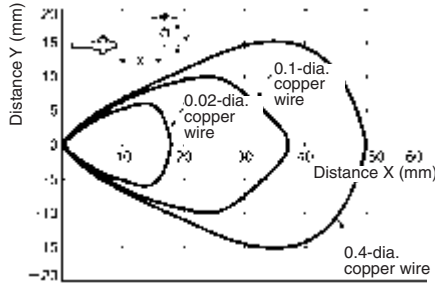

Hysteresis vs. Sensing Distance
E32-D11L (Reflective)

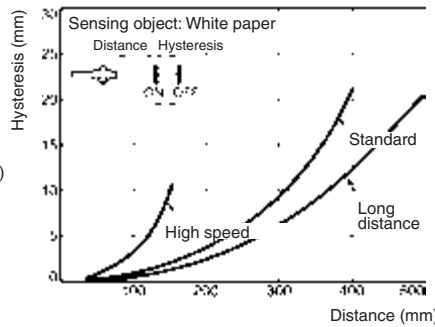

Repeat Accuracy vs. Sensing Distance
E32-DC200 (Reflective)

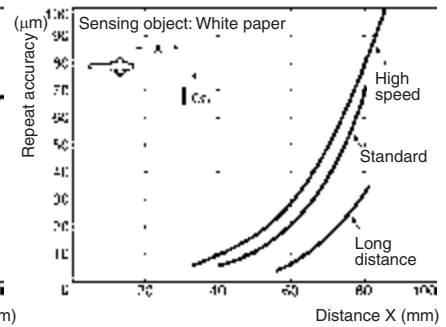

Analog Output vs. Distance (Standard Mode)

E32-TC200 (Through-beam)

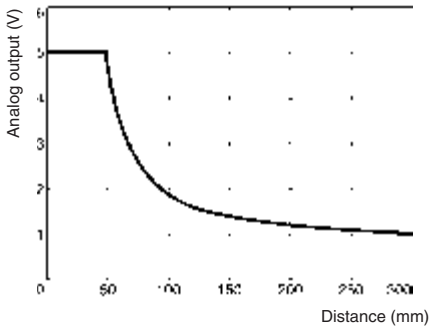

E32-DC200 (Reflective)

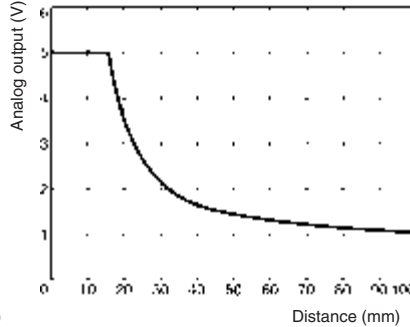

■ E3X-DAB□-N/E3X-DAG□-N

Parallel Operating Range

At max. sensitivity. (Use for optical axis adjustment at installation.)

E32-TC200 (Through-beam)

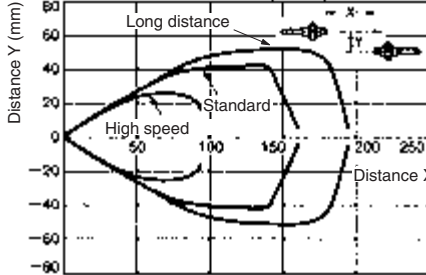

E32-TC200+E39-F1 (Through-beam)

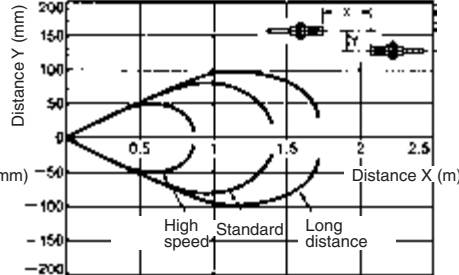

Operating Range

With standard sensing object at max. sensitivity. (Use for the positioning of the object and Sensor.)

E32-DC200 (Reflective)

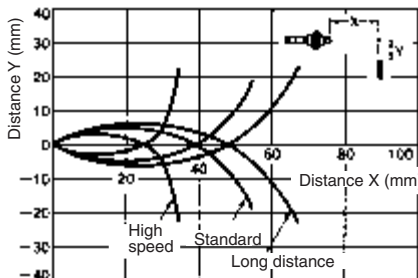

E32-CC200 (Reflective)

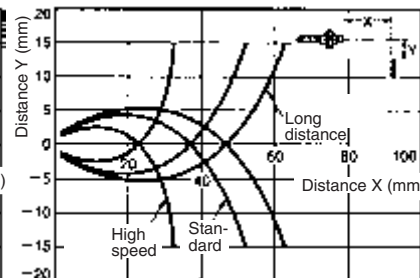

E32-D11L (Limited Reflective)

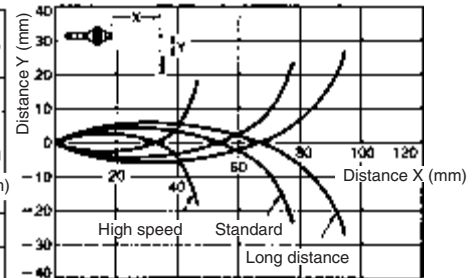

■ E3X-DAH-N

Parallel Operating Range

At max. sensitivity. (Use for optical axis adjustment at installation.)

**E32-TC200
(Through-beam)**

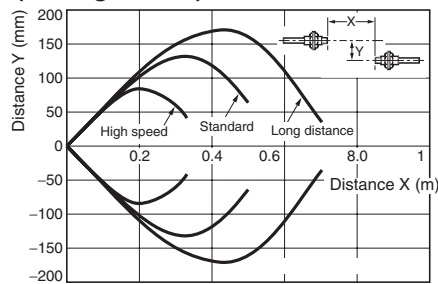

**E32-T11L
(Through-beam)**

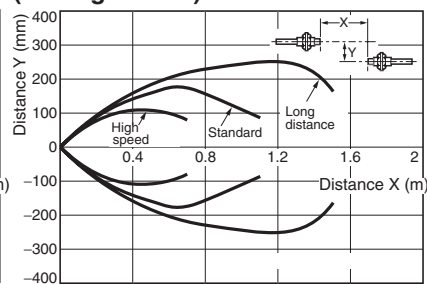

**E32-T14
(Through-beam)**

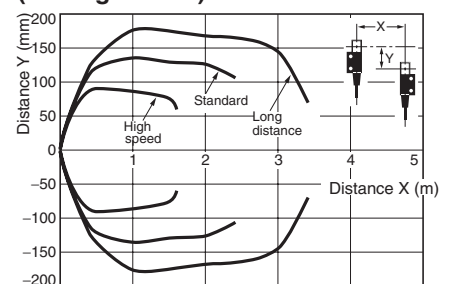

Operating Range

With standard sensing object at max. sensitivity. (Use for the positioning of the object and Sensor.)

**E32-DC200
(Reflective)**

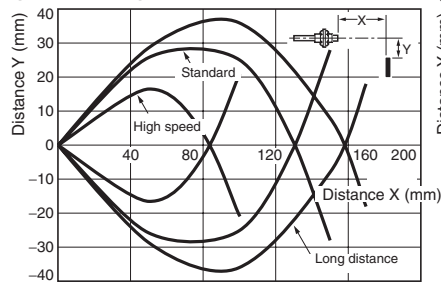

**E32-D11L
(Reflective)**

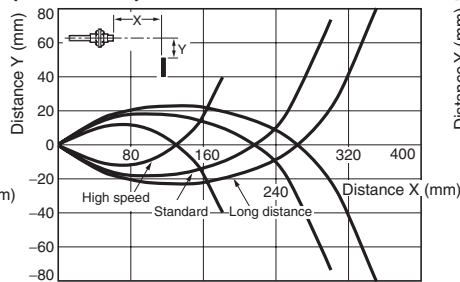

**E32-CC200
(Reflective)**

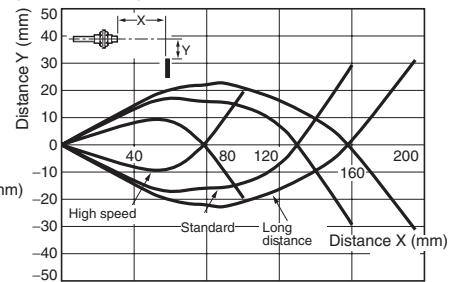

Nomenclature

■ Amplifier Units

Standard, Analog, Digital Output, Mark Detecting, Infrared and Water-Resistant models

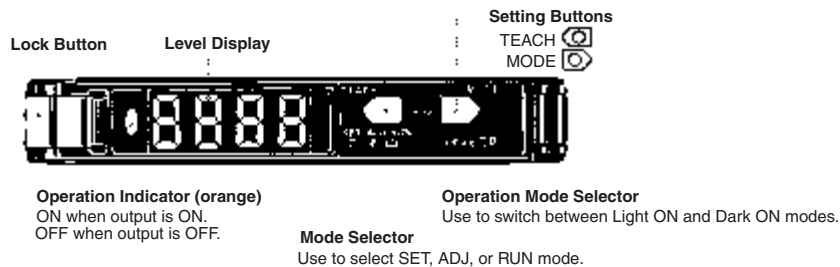

Models with Two Outputs

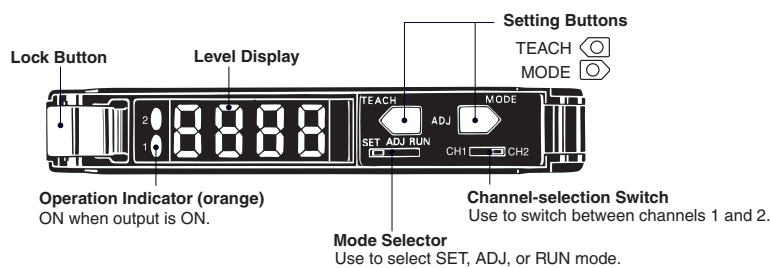

■ Display and Special Function Settings

Display Setting

The E3X-DA-N offers three display modes, which are Digital Incident Level display, Digital Percent display and Analog display.

- **Digital Incident Level Display:** the incident level is digitally displayed.
- **Digital Percent Display:** the threshold-based excess gain is displayed in percentage.
- **Bar Graph Display:** threshold and excess gain is displayed by two-color (red and green) bar graph.

Special Function Setting

The E3X-DA-N series has various functions that give users more flexibility in meeting a variety of application requirements.

- **Sensing Function:** Enables users to choose either standard sensing distance mode, long sensing distance mode or high speed mode
- **Timer Function:** Enables users to select various OFF-delay timer settings from 0 to 20 ms (set in 1 ms increments) and from 20 to 200 ms (set in 5 ms increments). OFF-delay timer lengthens the duration of a short, high-speed signal so that it can be recognized as input to Programmable Controllers during a scan cycle.
- **Flashing Function:** Flashing red LED allows easier optical axis adjustment.
- **Display Hold Setting:** This function provides easy data reading during optical axis adjustment and high-speed detection by holding the displayed value for a period of time. Displayed data gets updated every 2 seconds. Within the 2-second time frame, the maximum or minimum value is displayed (data will be flashing).
- **Display Orientation Setting:** Reversible digital display provides easy data reading from any mounting orientation.
- **Zero reset:** When activated, this function sets the incident level digital display to zero. This enables operators to easily monitor the difference between the maximum incident level and the minimum incident level.

Example: Zero reset used to calculate threshold setting

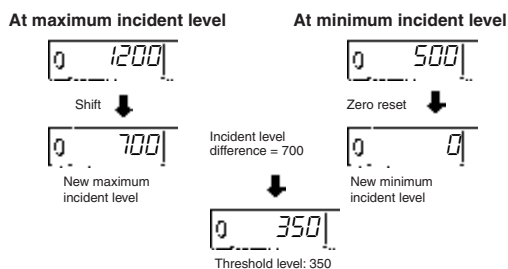

- **Initial reset:** Enables users to easily program the amplifier back to the default (factory) settings.
- **Monitor focus:** This feature is available on analog/digital output models. Without "monitor focus", the E3X-DA-N has to analyze an incident level range of 0 to 4095 to process a 1 to 5 VDC analog output. With the "monitor focus" function, the E3X-DA-N can narrow the range of the incident level to process a 1 to 5 VDC analog input by defining an upper and lower limit of the incident level. As a result, the sensor's resolution is increased.

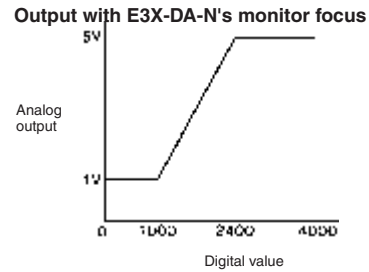
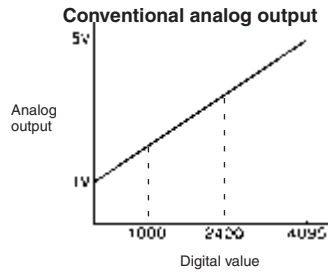

Example: Monitor focus increases resolution over a narrow range Upper limit = 2400 and lower limit = 1000



Settings

■ Teaching Functions

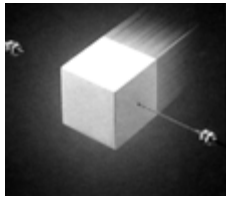
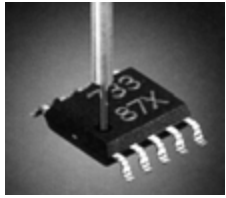
Four teaching methods are available to simplify setup and to allow changes in settings on the fly. The E3X-DA-N offers a new feature, "pinpoint teaching" for positioning

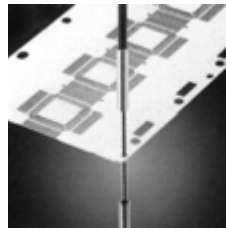
Teaching function	Application	Description
Maximum sensitivity setting		Use this function for sensing objects without backgrounds or through-beam sensing. It is ideal for detecting large objects.
Two-point teaching with or without object		Minute level differences as thin as a piece of paper can be detected. Detection of semi-transparent objects or the discrimination of object color is also possible.
One-point teaching without object		Set the sensitivity without stopping objects. This function allows automatic detection of differences between objects and the background. Use it to detect small moving items or thin objects such as gold wire.
Pinpoint teaching for positioning		Allows high precision positioning when detecting electronic components and other small items.

■ Adjustment: Teaching Functions (for all models)

The E3X-DA-N series offers 4 different types of teaching functions. The instructions below outline how to properly set each teaching function. The procedures for setting the teaching functions on the standard E3X-DA-N and the E3X-DA-TW models are essentially the same. For the E3X-DA-TW, however, users must select channel 1 and channel 2 independently prior to setting the teaching functions of each channel individually.

■ Maximum Sensitivity Setting (Teaching)

Set the mode selector to "SET" to start teaching. The red level display will flash if teaching error occurs. In this case, repeat the entire teaching procedure.

Maximum Sensitivity Setting

1. Set the "SET ADJ RUN" switch to "SET" position.



2. Press the "TEACH" button for 3 seconds (min.).



3. Teaching is complete when the level display changes from red to green. Digital incident level will appear shortly after the display changes from red to green.

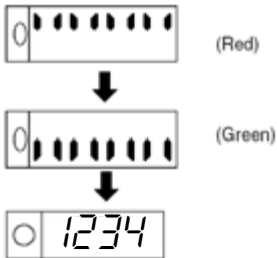

4. Set the "SET ADJ RUN" switch to "RUN" position to implement settings from the teach function.



■ One-point Teach Mode (without object)

1. Set the "SET ADJ RUN" switch to "SET" position.



2. Press the "TEACH" button for approximately 1 second.

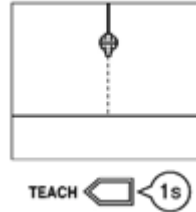

3. Teaching is complete when the red level display is lit. Digital incident level will appear shortly after the red level display is lit.

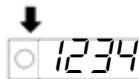

4. Set the "SET ADJ RUN" switch to "RUN" position to implement settings from the teach function.



5. The threshold is automatically set.

Note: Try the two-point teaching mode if the difference in level is too fine.

■ Two-point Teach Mode with/without object

1. Set the "SET ADJ RUN" switch to "SET" position.



2. Press the "TEACH" button for approximately 1 second when the object is at the sensing position.

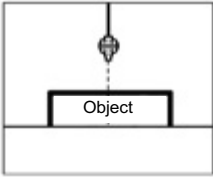

3. The red level display is lit.



4. Remove the object from the sensing area, and press the "TEACH" button for approximately 1 second.

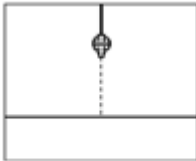

5. Teaching is complete when the green level display is lit. Digital incident level will appear shortly after the green display is lit. (The red level display will flash if a teaching error occurs.)

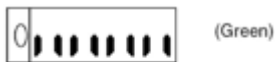

6. Set the "SET ADJ RUN" switch to "RUN" position to implement settings from the teach function.

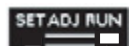

Note: The order of "with-object" and "without-object" setting procedures above can be reversed.

■ Pinpoint Teach Mode (Positioning)

1. Set the "SET ADJ RUN" switch to "SET" position.



2. Press the TEACH button for approximately 1 second with no object

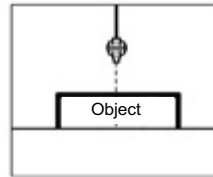

3. The red level display is lit.



4. Place the object in the desired position and press the TEACH button for 3 seconds minimum.

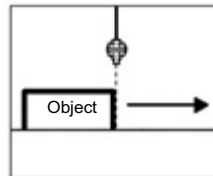

5. Teaching is complete when the green level display is lit. Digital incident level will appear shortly after the green display is lit. (The red level display will flash if a teaching error occurs.)



6. Set the "SET ADJ RUN" switch to "RUN" position to implement settings from the teach function.



■ Display Setting

E3X-DA-N can be programmed to display digital incident level, digital percent level or analog display.

1. Set the "SET ADJ RUN" switch to "RUN" position. Digital incident level should appear in the display.

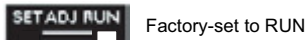

Factory-set to RUN

2. Press the "MODE" button until "123P" is displayed. Digital percent level is now displayed.



3. Press the "MODE" button to activate the "Bar Graph Incident Level" display. Two color (red and green) bar graph should appear in the display.

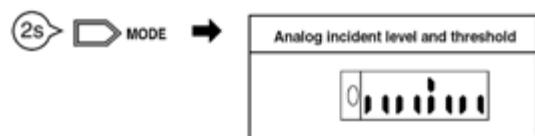

4. Press the "MODE" button to return to the "Digital Incident Level" display.



■ Special Function Setting

E3X-DA-N series has various functions that give users more flexibility in solving a variety of application requirements such as the following:

- Long sensing distance (Sensing Function)
- Faster response time (Sensing Function)
- Off-delay timer (Timer Function)
- Optical axis alignment (Flashing Function)
- Digital data display hold setting (Display Hold Setting)
- Data display orientation (Display Orientation Setting)
- Zero reset
- Initial reset
- Monitor focus

Sensing Function

1. Set the "SET ADJ RUN" switch to "SET" position.



2. Press the "MODE" button until "F 5t" is displayed. The "Standard" sensing function (F 5 t) is the default setting. The "Standard" sensing function provides the standard detecting distance. Response time is 1 ms.

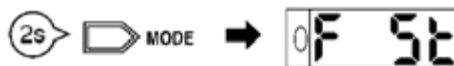

3. Press the "TEACH" button to obtain the "Long Distance" sensing function. "F Ld" should appear on the display. The "Long Distance" function provides a sensing distance that is about 1.3 times that of the "Standard" detecting distance (diffuse fiber in use). The "Long Distance" setting has a response time of 4 ms.



4. Press the "TEACH" button to obtain the "High Speed" sensing function. "F HS" should appear on the display. The "High Speed" function provides a detection distance that is about one-third of the standard distance (diffuse fiber in use). Response time is 250 μ s.



5. Press the "TEACH" button to return to the "Standard" sensing function display.



6. Set the "SET ADJ RUN" switch to "RUN" position to implement settings from the teach function.

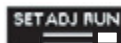

Timer Function

1. Set the "SET ADJ RUN" Switch to "SET" position.



2. Press and hold the "MODE" button until "t_0" is displayed. "t_0" is the default setting.



3. Press the "TEACH" button to set to the desired time setting:
1 ms increments from 0 to 20 ms
5 ms increments from 20 to 200 ms

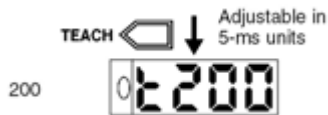

4. Set the "SET ADJ RUN" switch to "RUN" position to implement settings from the teach function.



Flashing Function

1. Set the "SET ADJ RUN" switch to "SET" position.



2. Press and hold the "MODE" button until "L OFF" is displayed. "L OFF" is the default setting.



3. Press the "TEACH" button to activate the "flashing" function. Display should read "L On"



4. Press the "TEACH" button to return to the "LOFF" mode.



5. Set the "SET ADJ RUN" switch to "RUN" position to implement settings from the teach function.



Display Hold Setting Function

1. Set the "SET ADJ RUN" switch to "SET" position.



2. Press and hold the "MODE" button until "HOFF" is displayed. "HOFF" is the default setting.



3. Press the "TEACH" button to activate "Peak Hold" display. Displayed data get updated every 2 seconds. The maximum value is displayed.



4. Press the "TEACH" button to activate "Bottom Hold" display. Displayed data gets updated every 2 seconds. The minimum value is displayed.



5. Press the "TEACH" button to return to the default setting. "HOFF".

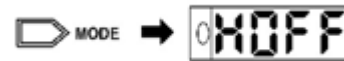

6. Set the "SET ADJ RUN" switch to "RUN" position to implement settings from the teach function.



Display Orientation Setting Function

1. Set the "SET ADJ RUN" switch to "SET" position.



2. Press and hold the "MODE" button until "d123" is displayed. "d123" is the standard setting.



3. Press the "TEACH" button to change the orientation of the display. "dE21" should now appear in the display.



4. Press the "TEACH" button to return to the standard setting, "d123".



5. Set the "SET ADJ RUN" switch to "RUN" position to implement settings from the teach function.



■ Monitor Focus

1. Set the "SET ADJ RUN" switch to "SET" position.



2. Press and hold the "MODE" button until "A-UP" is displayed.

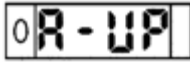

3. Press the "TEACH" button to set the desired "upper limit setting" of the incident level.



4. To set "lower limit setting," press the "MODE" button until "A-LO" is displayed. Press the "TEACH" button to set the lower limit setting.

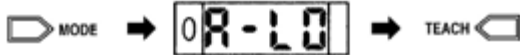

Note: It is not possible to set an "upper limit" that is lower than the value of the "lower limit". Conversely, it is not possible to set a "lower limit" that is greater than the value of the "upper limit"

5. Set the "SET ADJ RUN" switch to "RUN" position to implement settings from the teach function.



Note: Monitor focus is only available for the E3X-DA21-N, E3X-DA51-N, E3X-DA7 and the E3X-DA9.

■ Zero Reset Function

When activated, this function sets the incident level digital display to zero. This enables operators to easily monitor the difference between the maximum and the minimum incident levels.

1. Set the "SET ADJ RUN" switch to "RUN" position.



2. Press the "TEACH" button for 1 second. A zero should appear in the display.



3. Press the "TEACH" and "MODE" buttons simultaneously for 3 seconds to return to the initial incident level display.

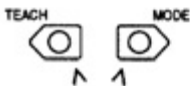

Hold down for 3 seconds

■ Initial Reset

This function enables users to cancel program input and reset the amplifier back to the default (factory) setting

1. Set the "SET ADJ RUN" switch to "SET" position.



2. Press the "TEACH" and "MODE" buttons simultaneously for 5 seconds until "NO?" is displayed.

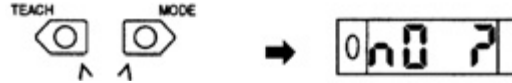

Hold down for 5 seconds

To cancel "Initial Reset" function, simply press the "MODE" button.

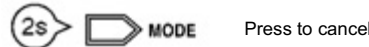

To implement the "Initial Reset" function, first press the "TEACH" button until "YES?" appears in the display.



Press the "MODE" button to execute the "Initial Reset" function.



3. Set the "SET ADJ RUN" switch to "RUN" position to implement settings from the teach function.]



■ Setting The Light-ON/Dark-ON Mode For The E3X-DA-TW

The procedures for setting the E3X-DA-TW's "special functions" are the same as the procedures for the standard E3X-DA-N with the following exceptions:

1. Select the channel that you want to set by moving the switch to either the "CH1" or "CH 2" position.

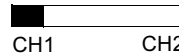

2. Set the "SET ADJ RUN" switch to SET position



3. Press and hold the "MODE" button. If CH1 was selected in step 1, then "1LOn" will be displayed. "2LOn" will be displayed if CH2 was selected.



4. Press the "Teach" button to change to "1dOn or "2dOn". This again depends on which channel was initially selected.



5. Set the "SET ADJ RUN" switch to "RUN" position to implement settings.



Technical Reference (for E3X-DA-TW With Two Independent Outputs)

Output Patterns for Normal Operation

The E3X-DA-TW's two independently configurable outputs enable customers to solve applications that historically required two sensors with just one sensor. In addition to being able to independently configure the two outputs, customers can also separately select either Light-ON or Dark-ON mode in channels 1 and 2, bringing the possible output patterns to four. With the four output patterns, customers are able to further increase their application's flexibility. The following examples illustrate some of the output patterns that can be attained with the E3X-DA-TW models. Threshold 1 is set to 3,000 and threshold 2 is set to 1,000.

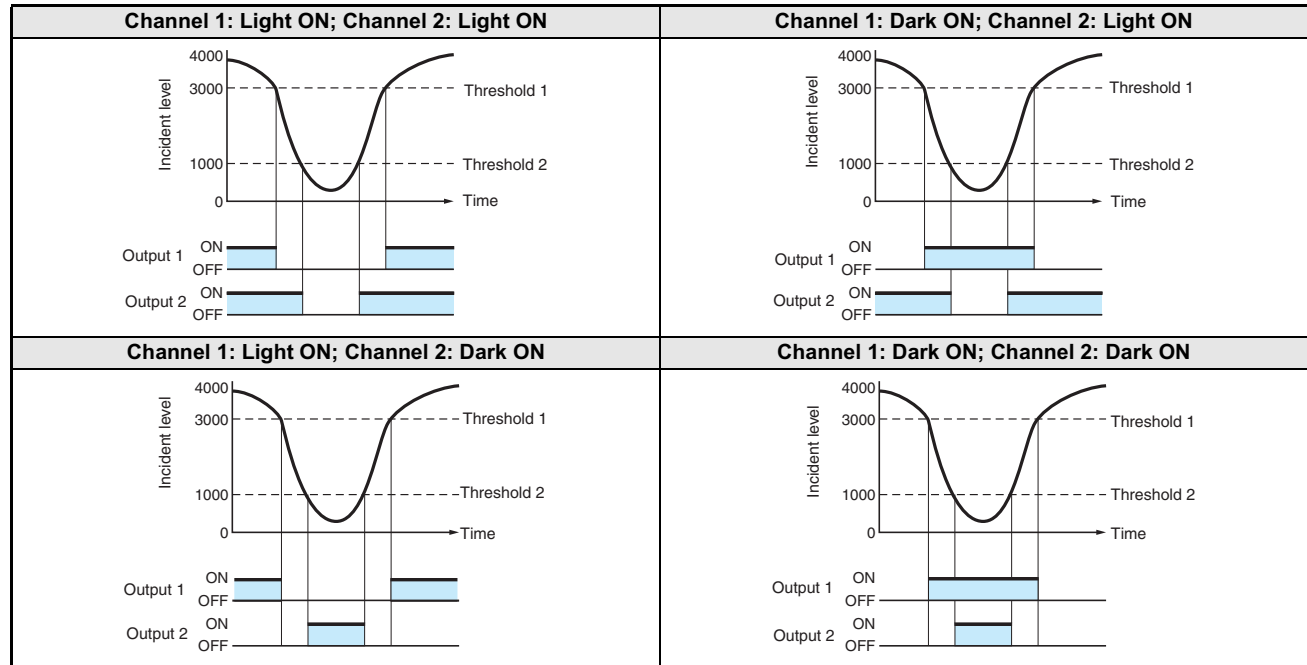

Output Patterns for Area Sensing

The multiple output patterns can also be used to set a "sensing area". With the multiple output patterns, users are able to monitor whether the incident level is inside or outside the threshold area. The output patterns below illustrate how a "sensing area" can be established.

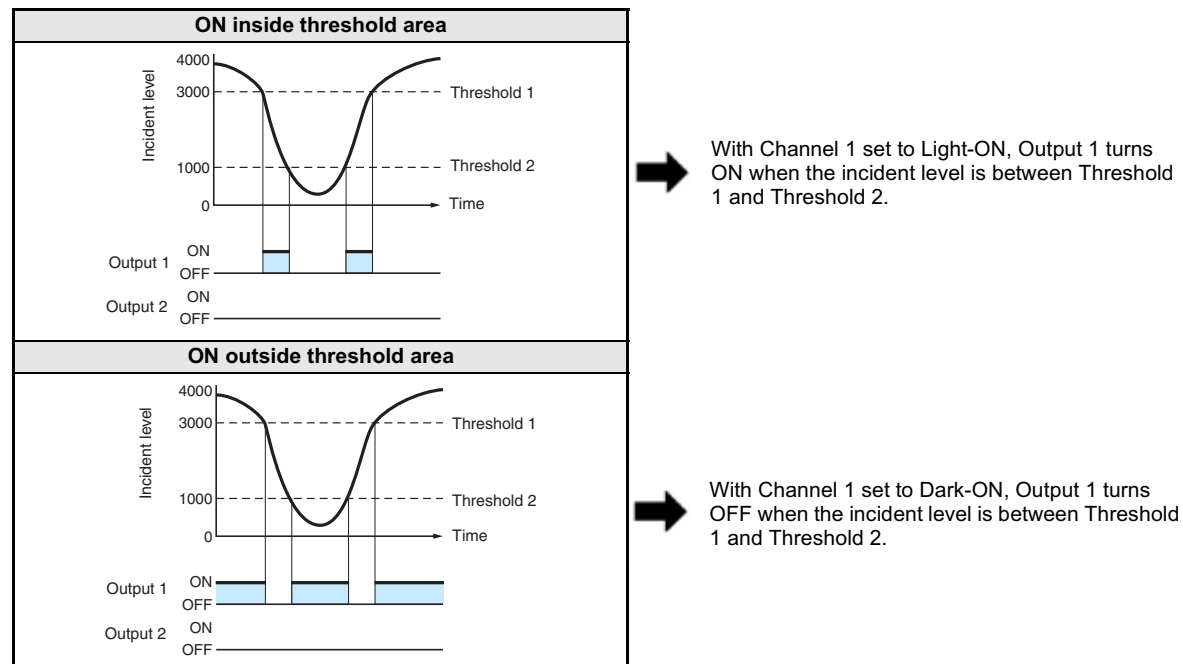

Note: Output 2 is always OFF.

Dimensions

Unit: mm (inch)

■ Amplifier Units

Amplifier Units with Cables

- E3X-DA11-N E3X-DAG11-N
- E3X-DA21-N E3X-DAH11-N
- E3X-DAB11-N E3X-DAB41-N
- E3X-DA41-N E3X-DAG41-N
- E3X-DA51-N E3X-DAH41-N

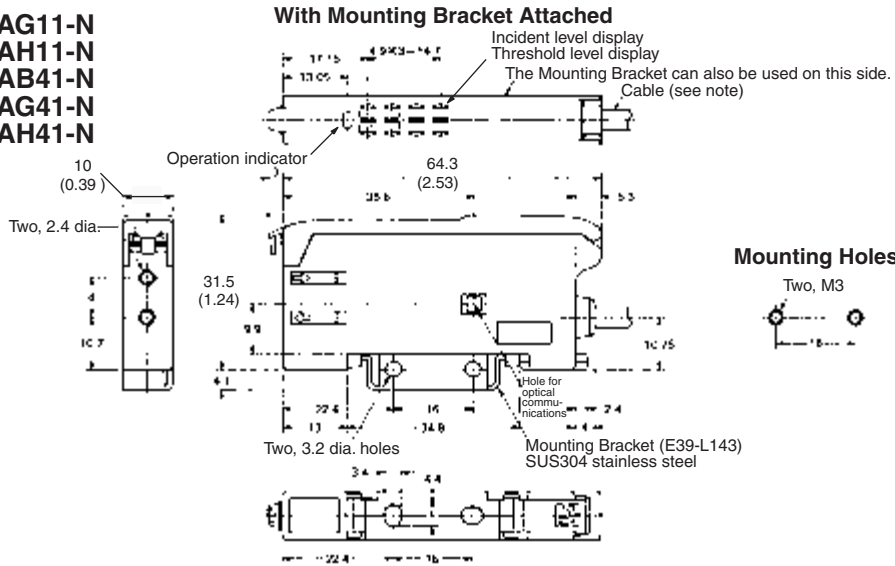
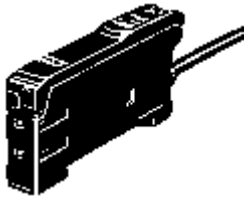

Note: E3X-DA11-N/DA41-N/DAB11-N: A 4-dia., 3-conductor, vinyl-insulated round cable (conductor cross-sectional area: 0.45mm²; insulation diameter: 1.1 mm) is used.

E3X-DA21-N/DA51-N: A 4-dia., 4-conductor, vinyl-insulated round cable (conductor cross-sectional area: 0.2mm²; insulation diameter: 1.1 mm) is used.

Amplifier Units with Cables, Water-resistant Models

- E3X-DA11V
- E3X-DA41V

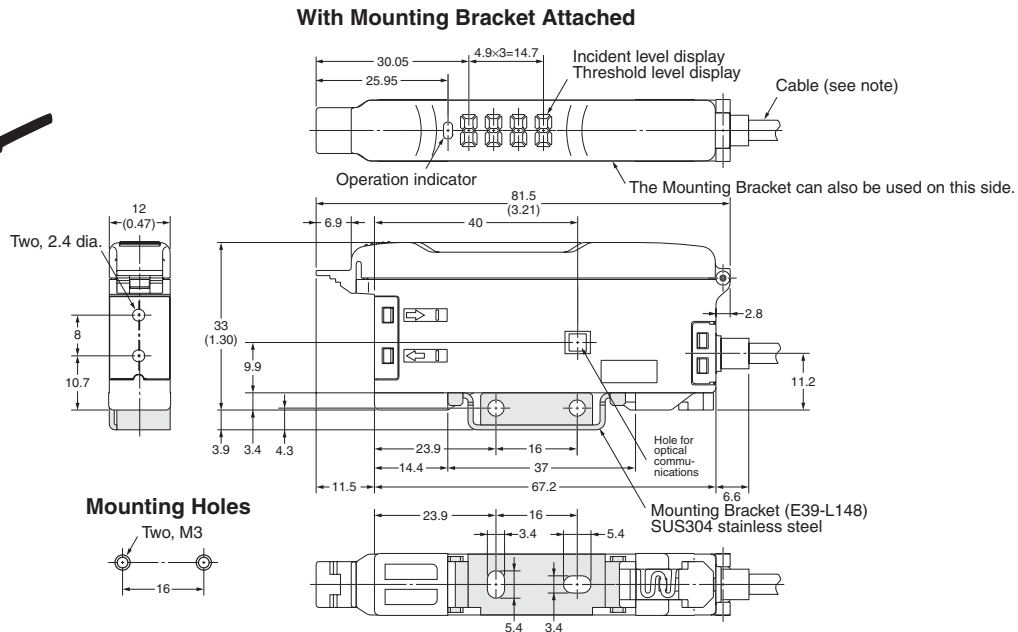
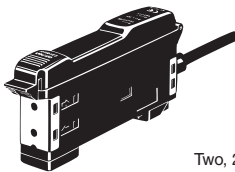

Note: A 4-dia., 3-conductor, vinyl-insulated round cable (conductor cross-sectional area: 0.45 mm²; insulation diameter: 1.1 mm) is used. Standard length=2 m.

Amplifier Units with Cables, Twin-output Models

E3X-DA11TW
E3X-DA41TW

With Mounting Bracket Attached

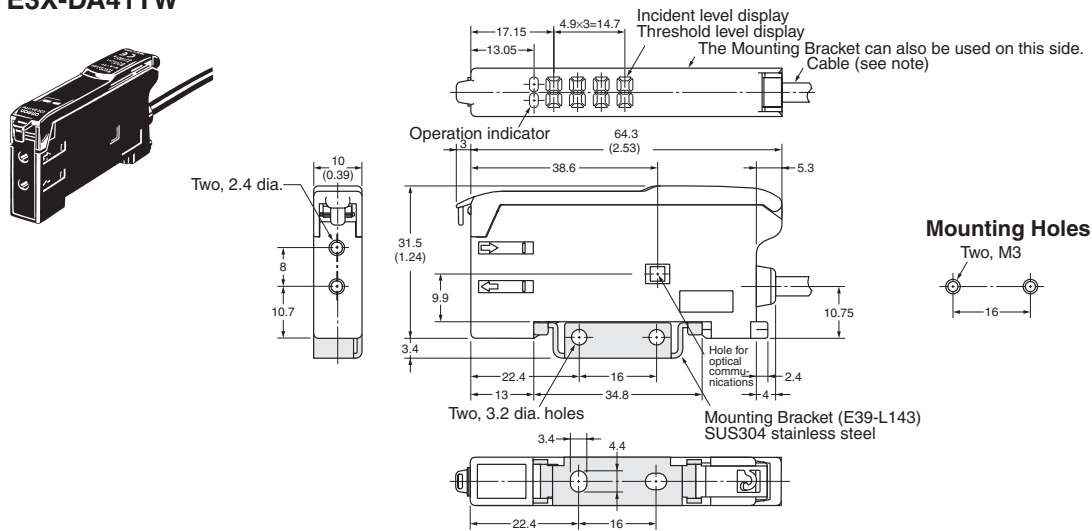

Note: A 4-dia., 4-conductor, vinyl-insulated round cable (conductor cross-sectional area: 0.2 mm²; insulation diameter: 1.1 mm) is used.

Amplifier Units with Standard Connectors

E3X-DA6 E3X-DAG6
E3X-DA6P E3X-DAH6
E3X-DA7 E3X-DA8
E3X-DAB8 E3X-DAG8
E3X-DA9 E3X-DAH8
E3X-DAB6

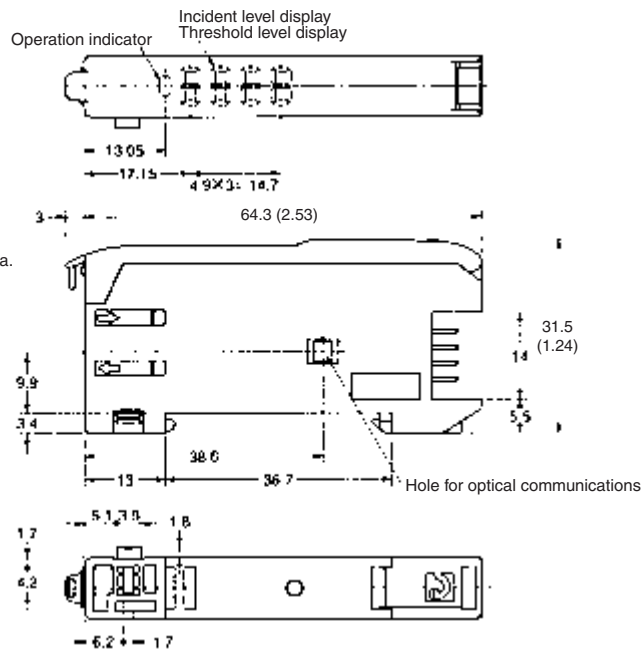

Dimensions with Master Connector Connected

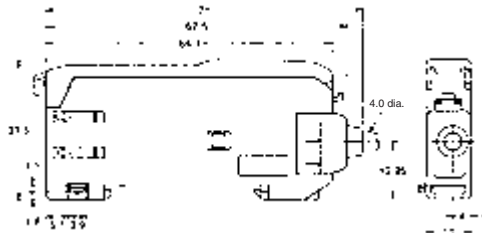

Dimensions with Slave Connector Connected

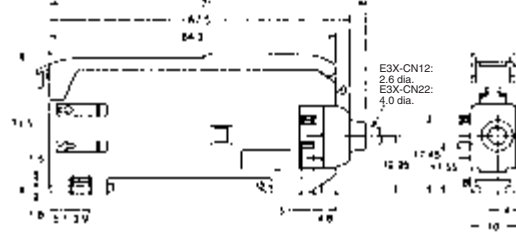

Unit: mm (inch)

Amplifier Units with M8 Connectors, Water-resistant Models

**E3X-DA14V
E3X-DA44V**

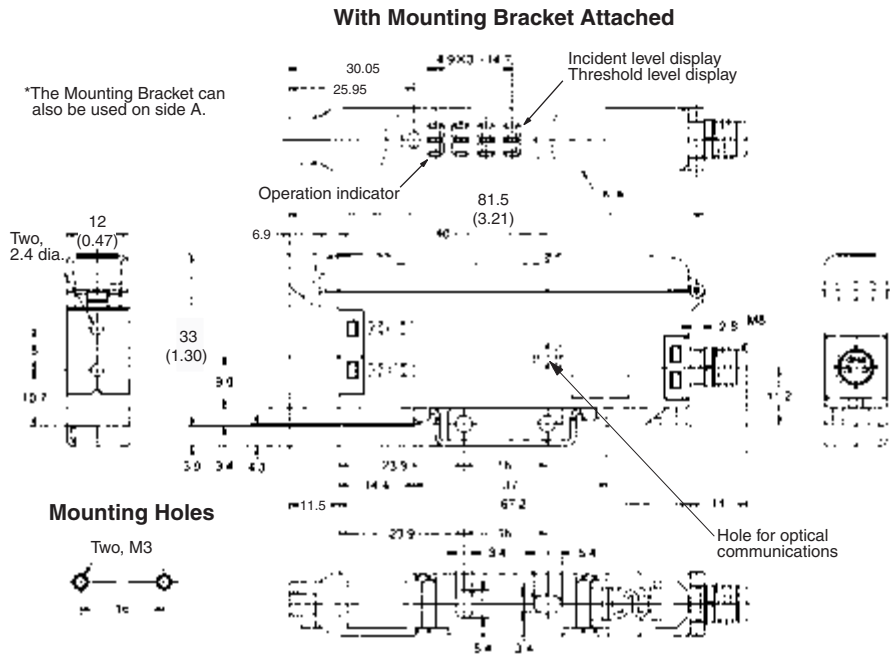
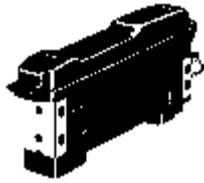

Amplifier Units with Standard Connectors, Twin-output Models

**E3X-DA6TW
E3X-DA8TW**

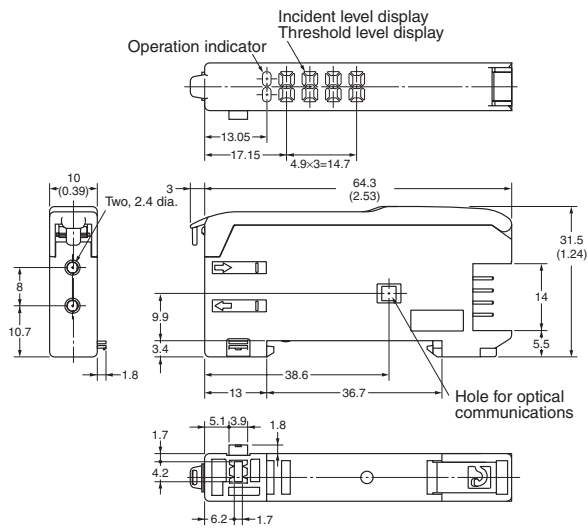
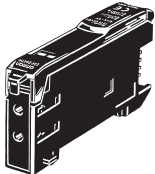

Dimensions with Master Connector Connected

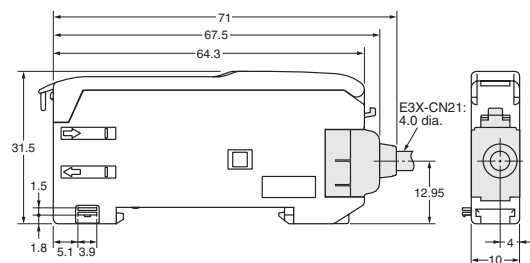

Dimensions with Slave Connector Connected

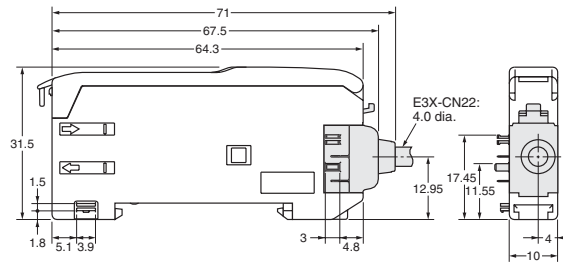

■ Terminal Block

E39-TM1

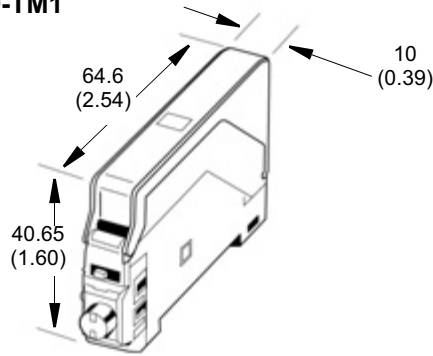

■ Wire-Saving Connector Cord Sets

Master Connectors

E3X-CN11

E3X-CN21

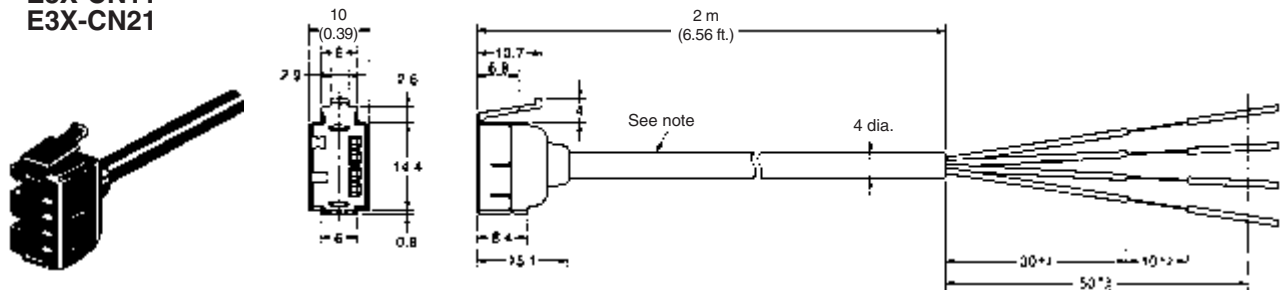

Note: E3X-CN11: A 4-dia., 3-conductor, vinyl-insulated round cable (conductor cross-sectional area: 0.2 mm^2 ; insulation diameter: 1.1 mm) is used.

E3X-CN21: A 4-dia., 4-conductor, vinyl-insulated round cable (conductor cross-sectional area: 0.2 mm^2 ; insulation diameter: 1.1 mm) is used.

Slave Connectors

E3X-CN12

E3X-CN22

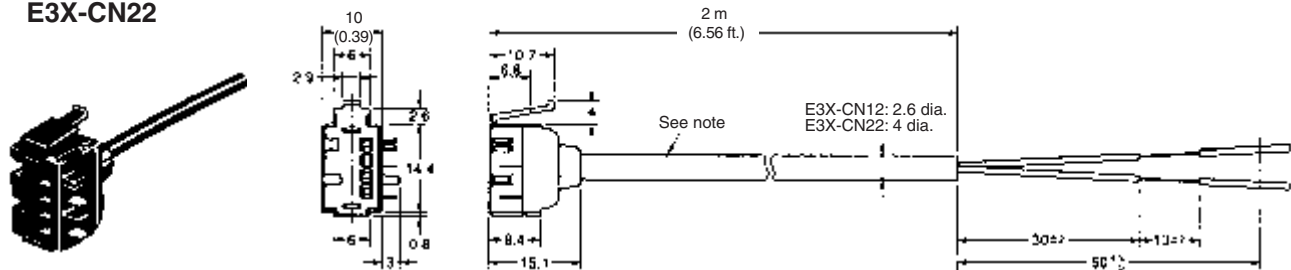

Note: E3X-CN12: A 2.6-dia., single-conductor, vinyl-insulated round cable (conductor cross-sectional area: 0.2 mm^2 ; insulation diameter: 1.1 mm) is used.

E3X-CN22: A 4-dia., 2-conductor, vinyl-insulated round cable (conductor cross-sectional area: 0.2 mm^2 ; insulation diameter: 1.1 mm) is used.

Cordless Slave Connector

E3X-CN02

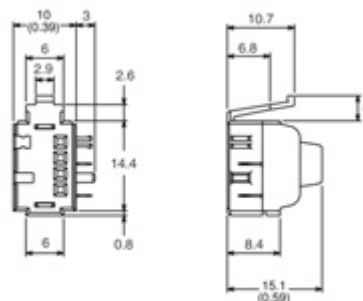

Note: For information on use of the E3X-CN02, refer to the Fiber Amplifiers for DeviceNet, CompuBus/S and RS-422 Network Communications table on page 3 of this data sheet.

Unit: mm (inch)

■ Sensor I/O Connectors

Straight Connector (at one end of cable)

XS3F-M421-402-A (L=2 m)

XS3F-M421-405-A (L=5 m)

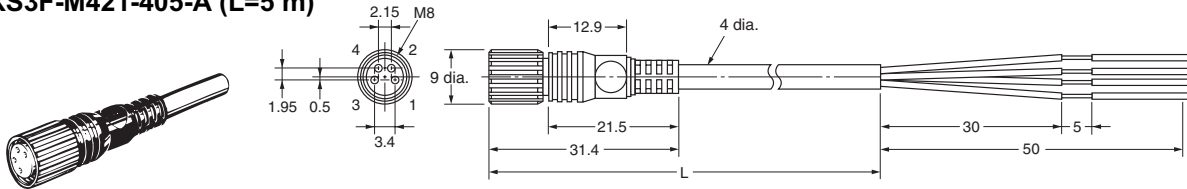

L-Shaped Connector (at one end of cable)

XS3F-M422-402-A (L=2 m)

XS3F-M422-405-A (L=5 m)

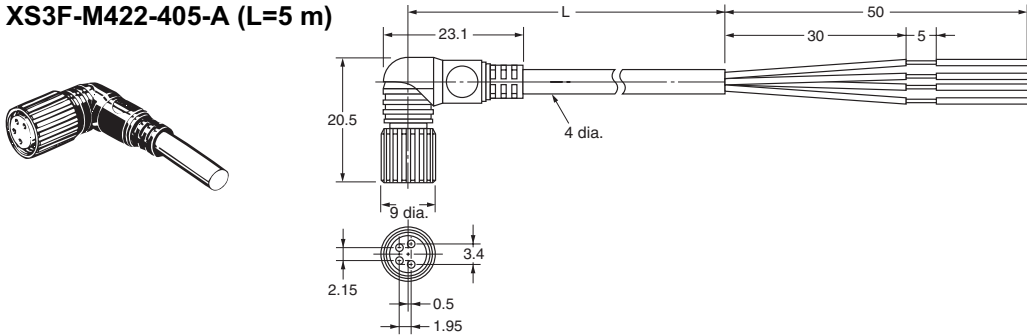

Straight Connector (at both ends of cable)

XS3F-M421-402-R

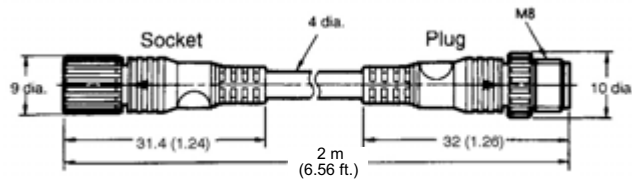

■ Mobile Console

(Set: E3X-MC11)

(Console only: E3X-MC11-C1)

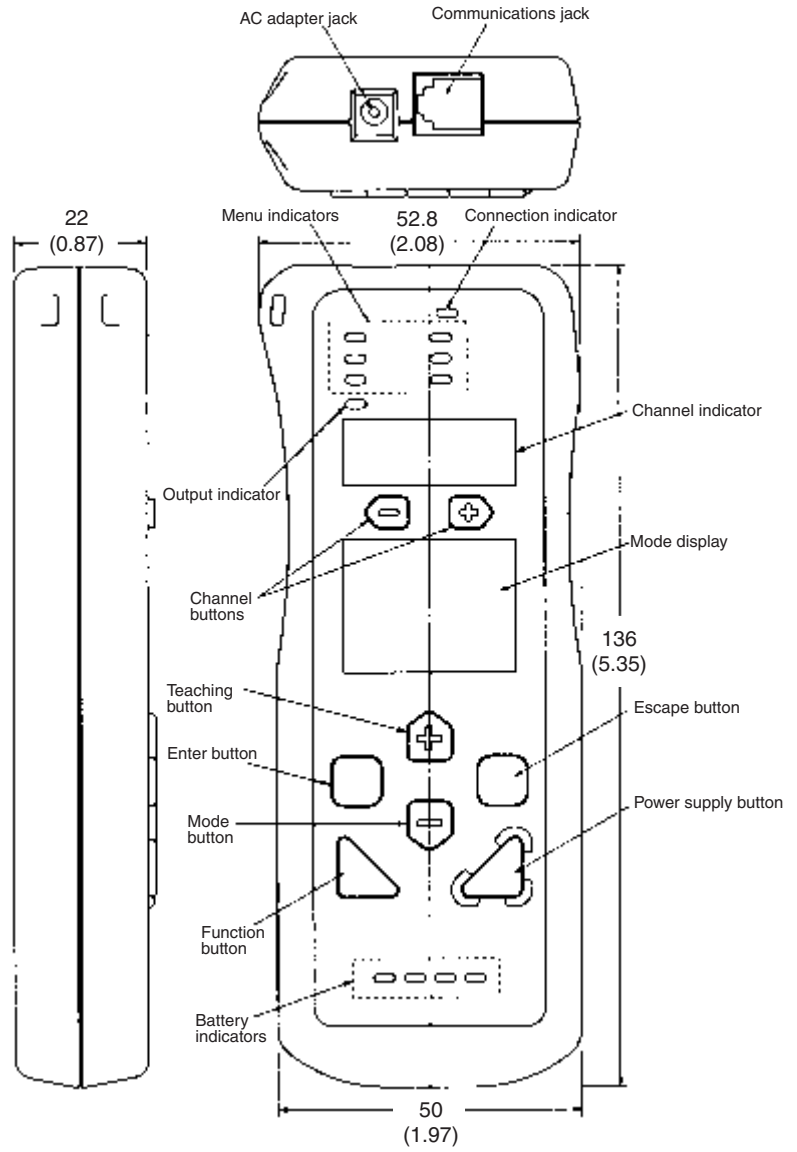

Mobile Console Head
(E3X-MC11-H1)

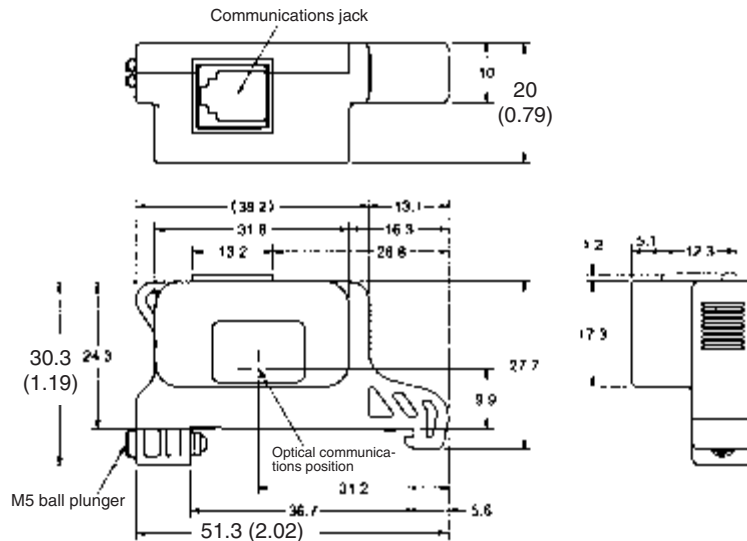

Unit: mm (inch)

Mounting Brackets

E39-L143

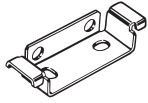

Material: Stainless steel (SUS304)

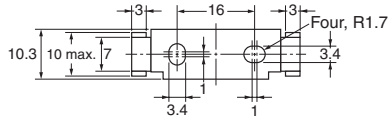

Mounting Holes

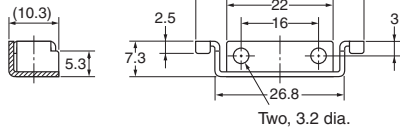
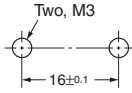

E39-L148

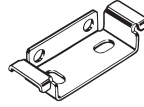

Material: Stainless steel (SUS304)

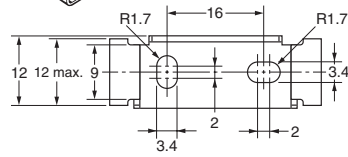

Mounting Holes

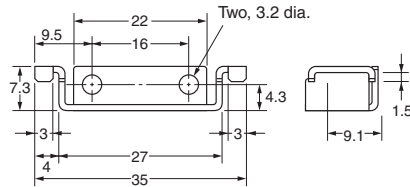
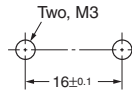

End Plate

PFP-M

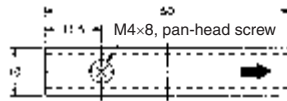

M4 spring washer

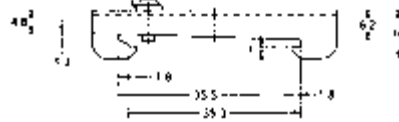

Fiber Optic Cables

Unit: mm (inch)

Through-beam Fiber Units (Sold in Pairs)

(Free-cut) Indicates models that allow free cutting. Models without this mark do not allow free cutting.)

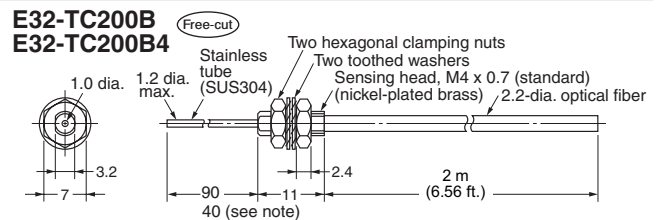
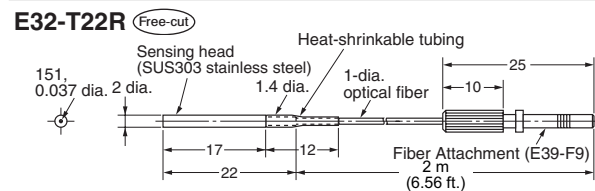
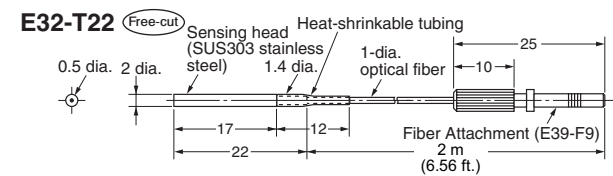
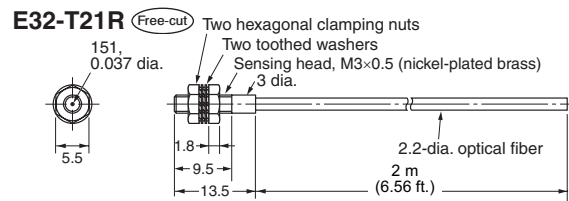
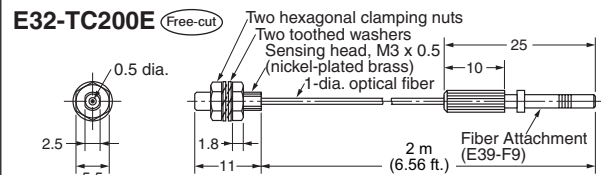
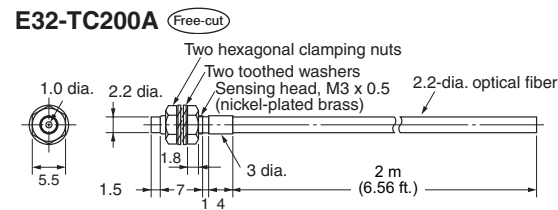
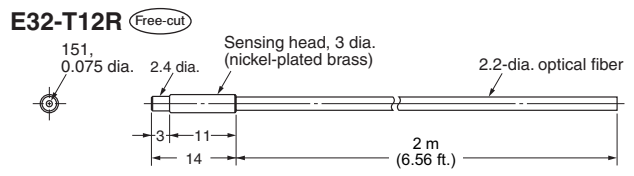
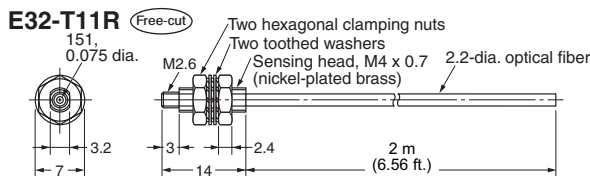
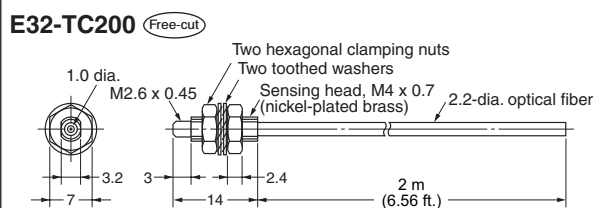
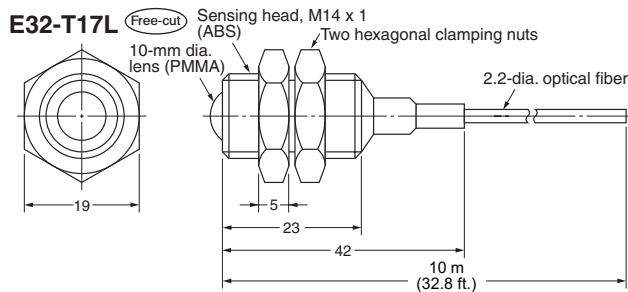
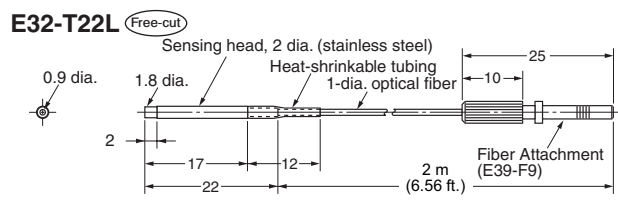
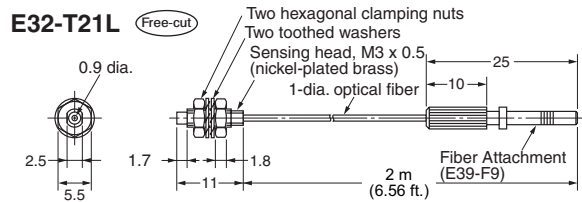
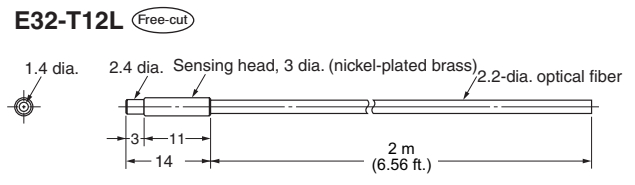
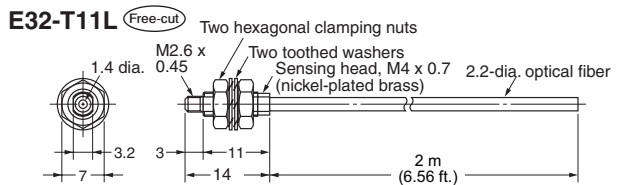

Note: The value in the parentheses is for the E32-TC200B4.

Unit: mm (inch)

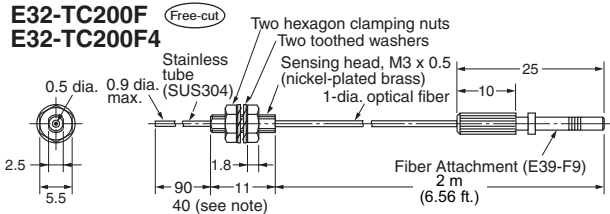

Note: The value in the parentheses is for the E32-TC200F4.

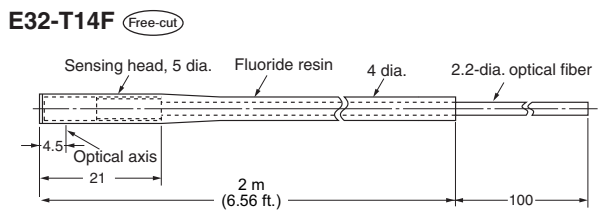
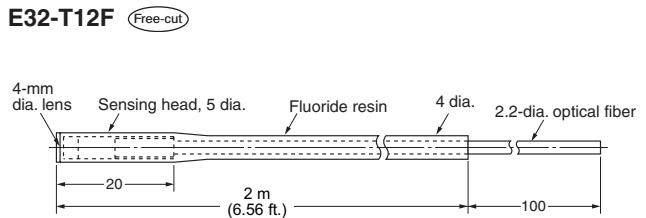
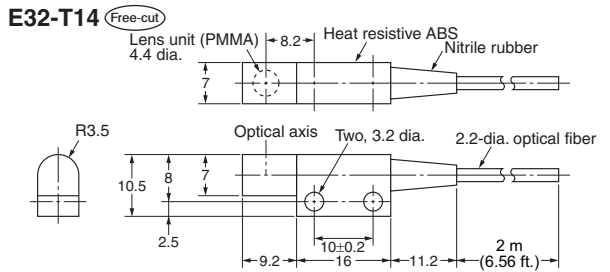
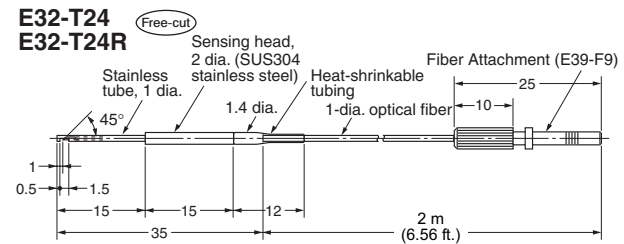
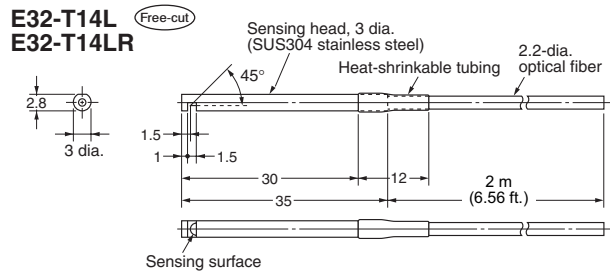
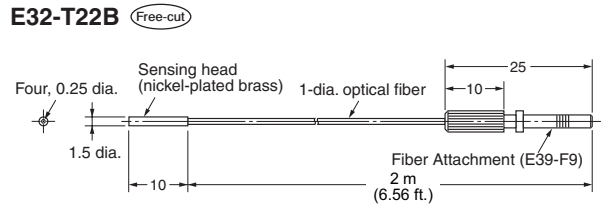
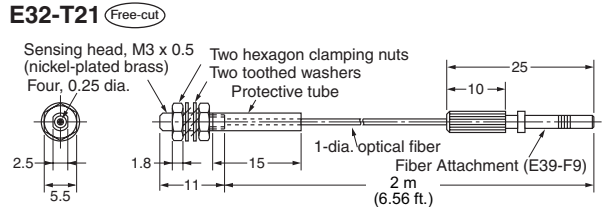
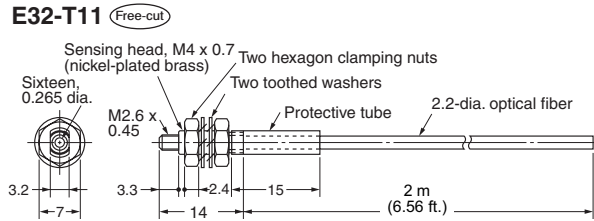

E32-T81F

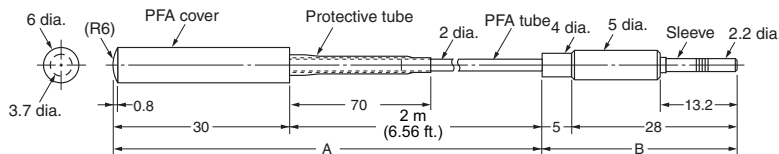

Note: Section A resists 200°C and section B resists 110°C.

E32-T81R

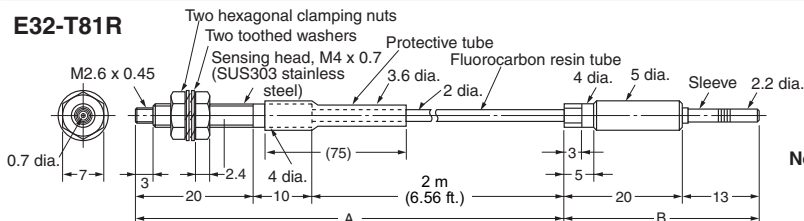

Note: Section A resists 200°C and section B resists 110°C.

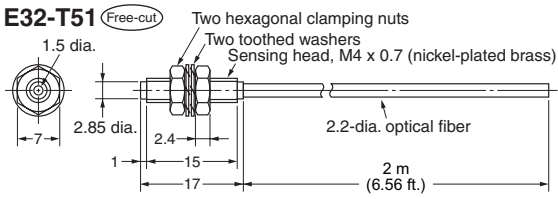

Note: Resistant temperature is 150°C.
Resistant temperature is 130°C
when used continuously.

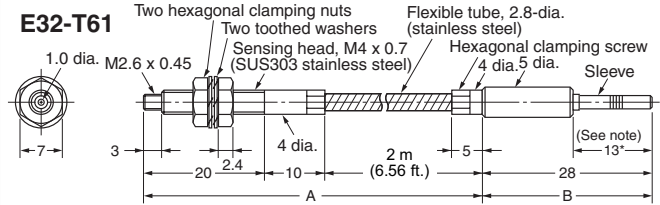

Note: Section A resists 300°C and section B (which is inserted to the Amplifier) resists 110°C.
The operating temperature of the section to be inserted into the Sensor (marked with *) must be within the operating temperature range of the Amplifier.

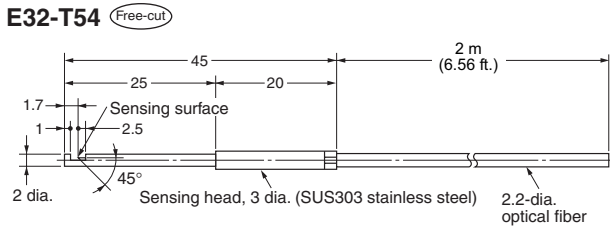

Note: Resistant temperature is 150°C.
Resistant temperature is 130°C
when used continuously.

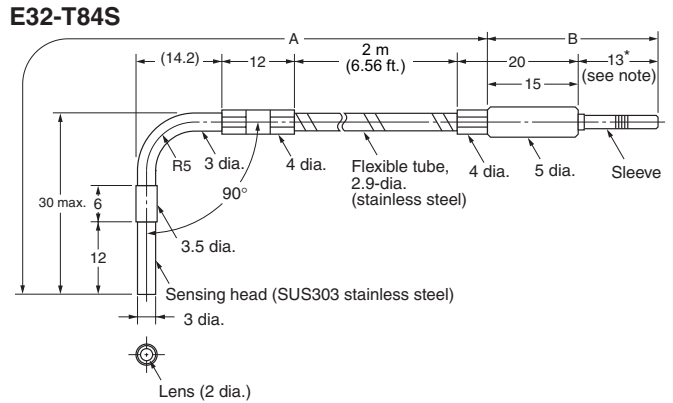

Note: Section A resists 200°C and section B (which is inserted to the Amplifier) resists 110°C.
The operating temperature of section to be inserted into the Sensor (marked with *) must be within the operating temperature range of the Amplifier.

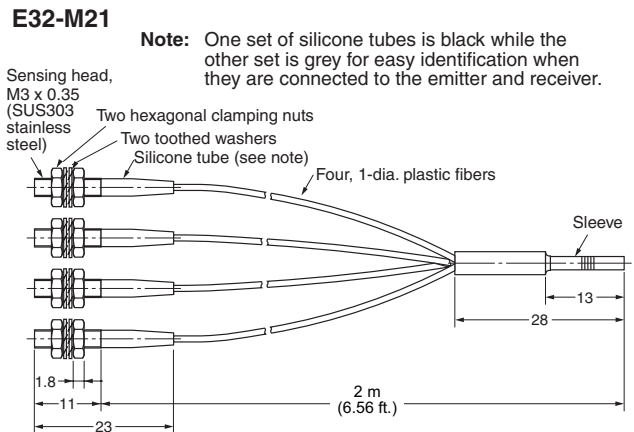
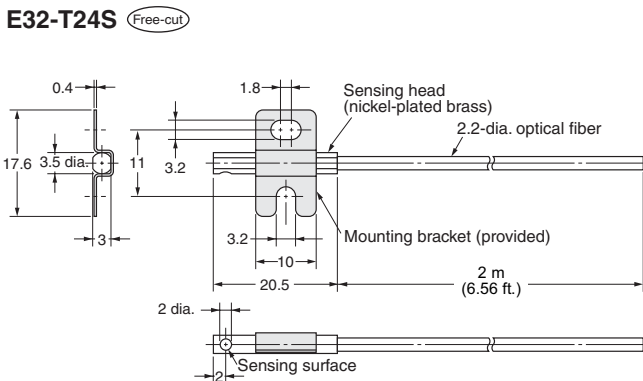
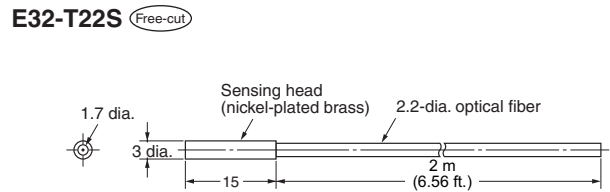
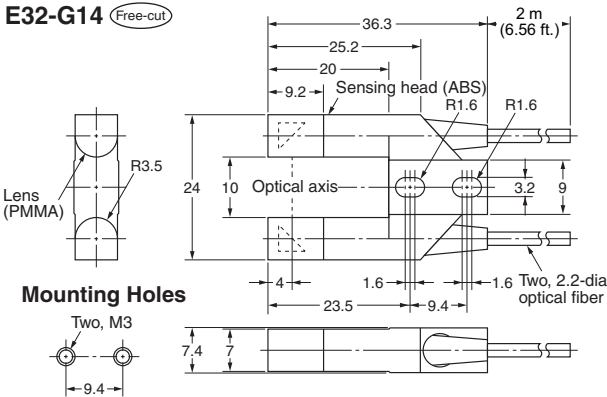

Unit: mm (inch)

**E32-T16W
E32-T16WR**

(Free-cut)

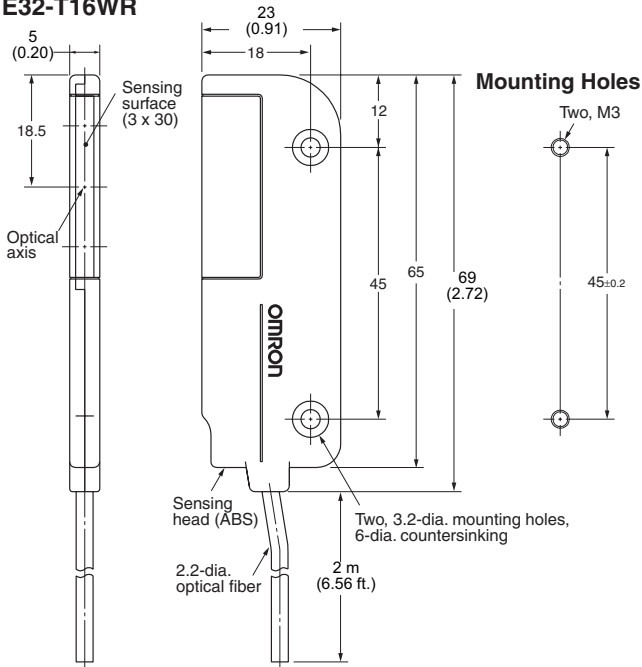

**E32-T16J
E32-T16JR**

(Free-cut)

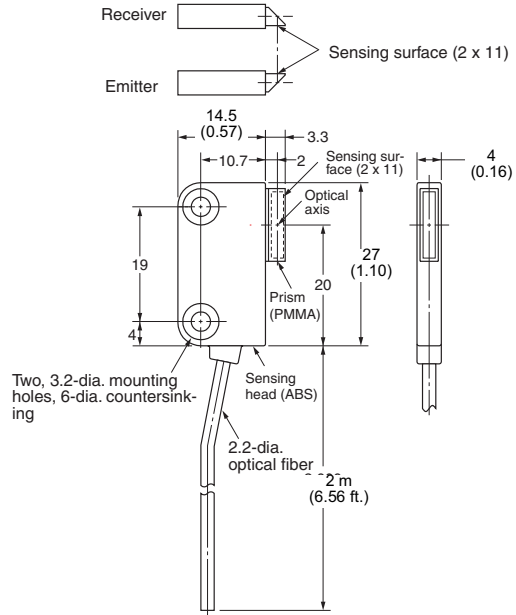

E32-T16

(Free-cut)

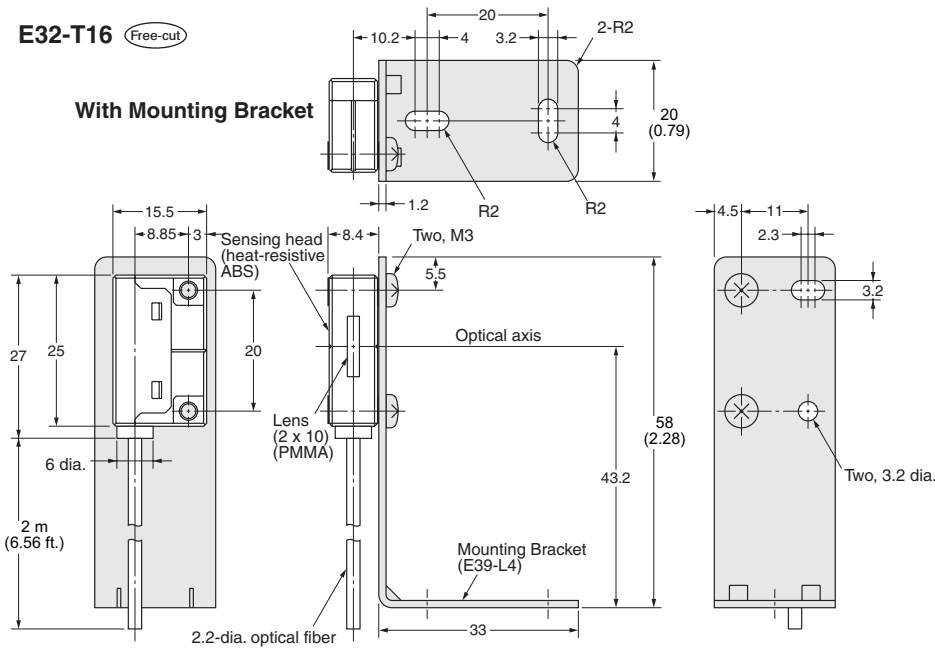

Mounting Holes

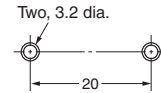

**0.5-mm-wide Slit Seal
(Supplied with the Unit in Pairs)**

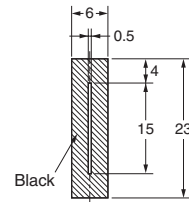

**1-mm-wide Slit Seal
(Supplied with the Unit in Pairs)**

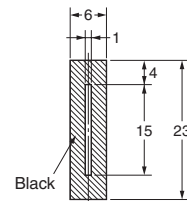

Unit: mm (inch)

E32-T16P (Free-cut)
E32-T16PR

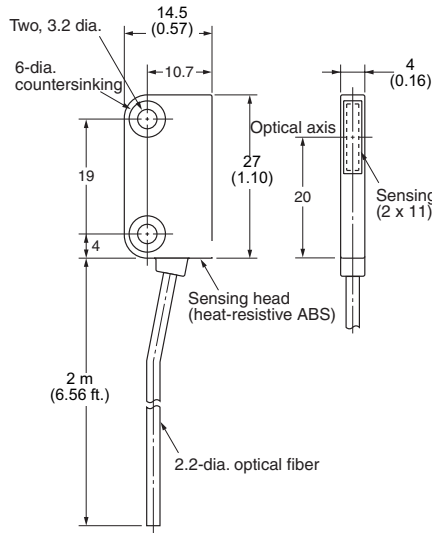

0.5-mm-wide Slit Seal
 (Supplied with the Unit in Pairs)

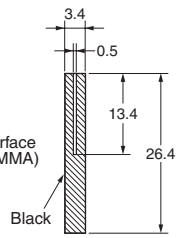

1-mm-wide Slit Seal
 (Supplied with the Unit in Pairs)

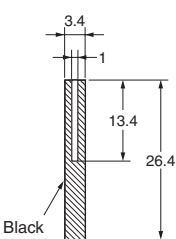

With Mounting Bracket

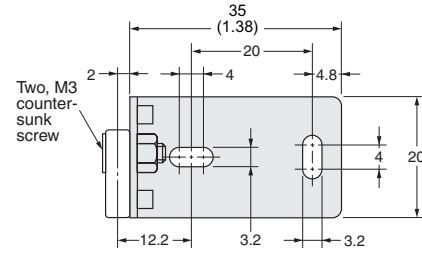

Mounting Holes

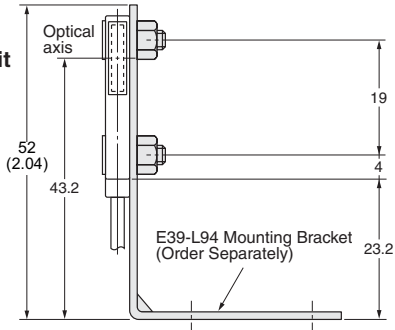
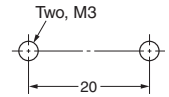

■ Reflective Fiber Units

Unit: mm (inch)

(Free-cut) Indicates models that allow free cutting. Models without this mark do not allow free cutting.

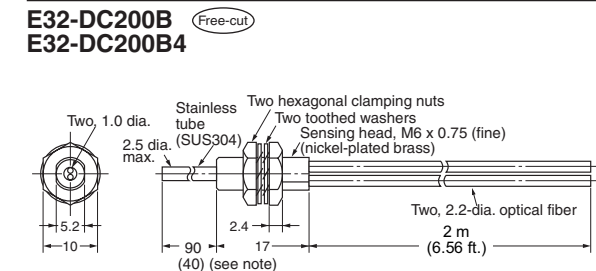
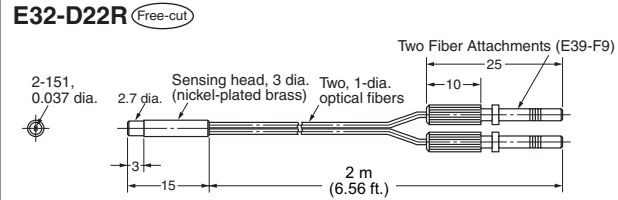
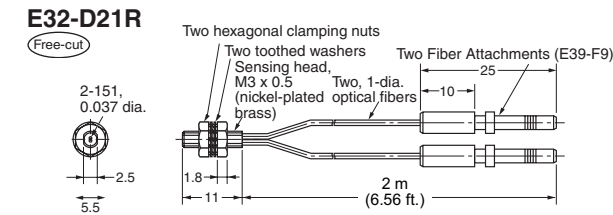
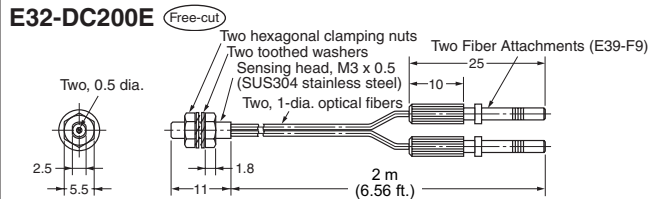
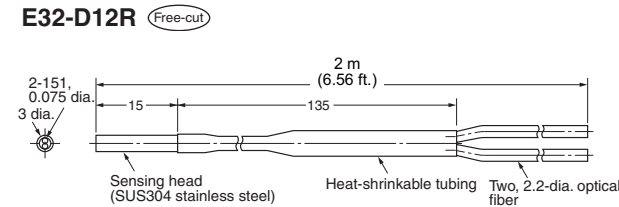
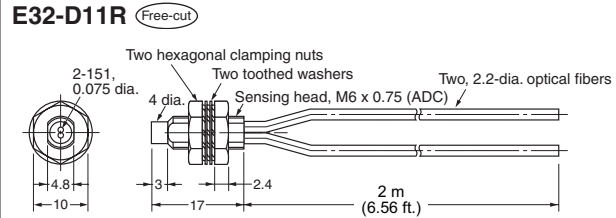
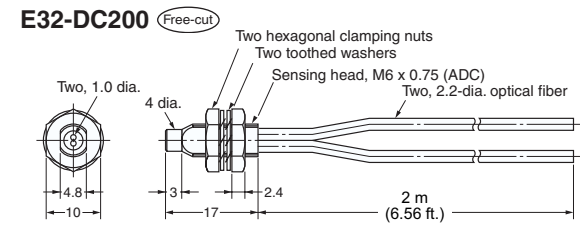
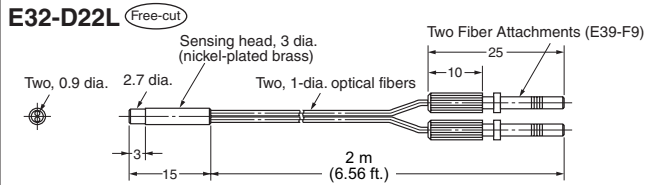
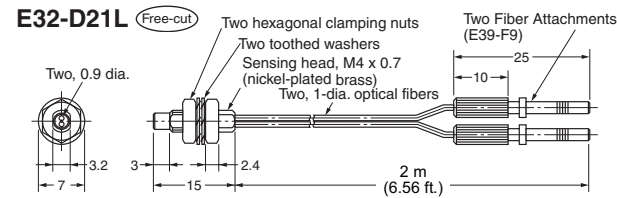
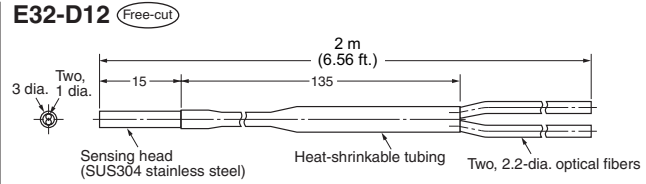
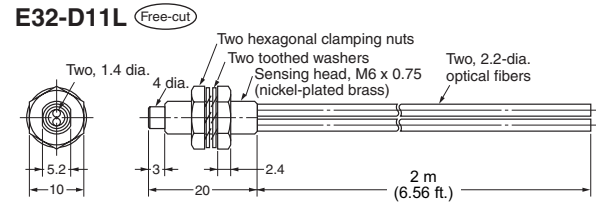

Note: The value in the parentheses is for the E32-DC200B4.

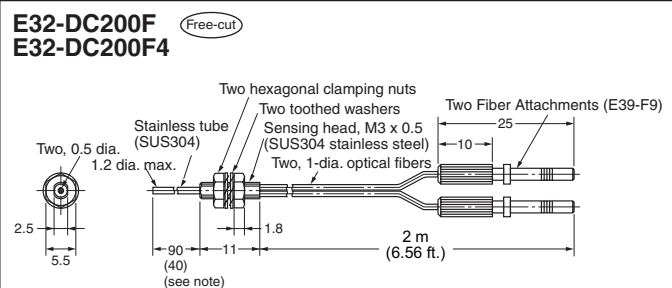

Note: The value in the parentheses is for the E32-DC200F4.

E32-D33 (Free-cut)

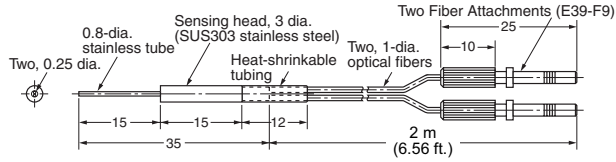

E32-D331

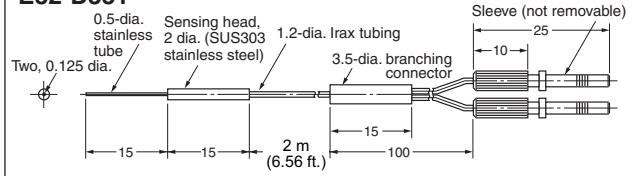

E32-D11 (Free-cut)

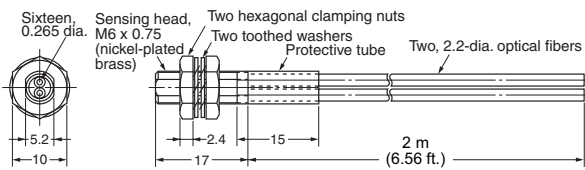

E32-D21 (Free-cut)

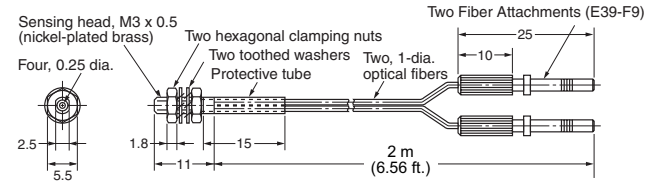

E32-D21B (Free-cut)

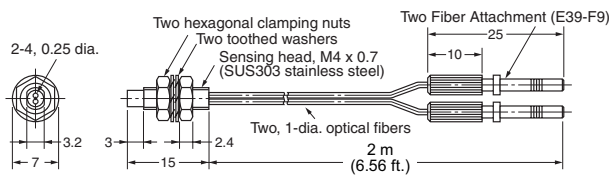

E32-D22B

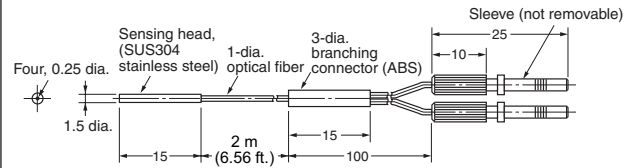

E32-CC200 (Free-cut)

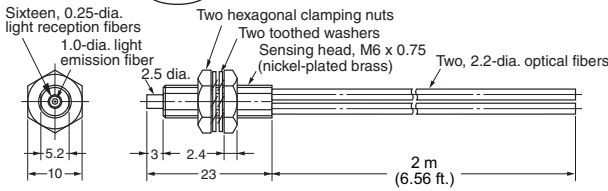

E32-D32L (Free-cut)

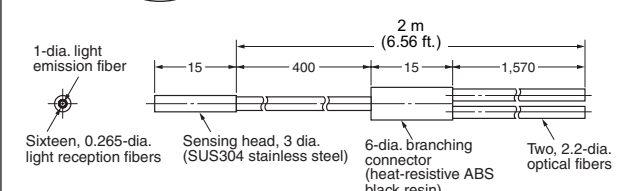

Note: The fiber for the emitter is identified by a white line.

Note: The fiber for the emitter is identified by a yellow dotted line.

E32-C31 (Free-cut)

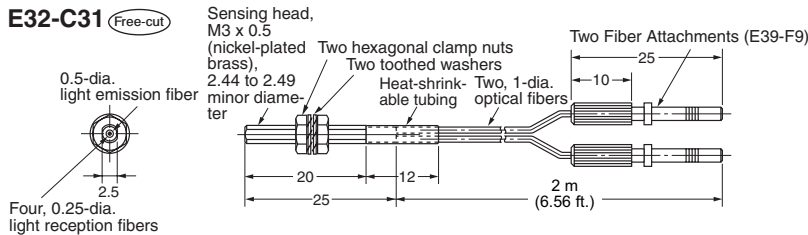

Note: The fiber for the emitter is identified by a white line.

E32-C41

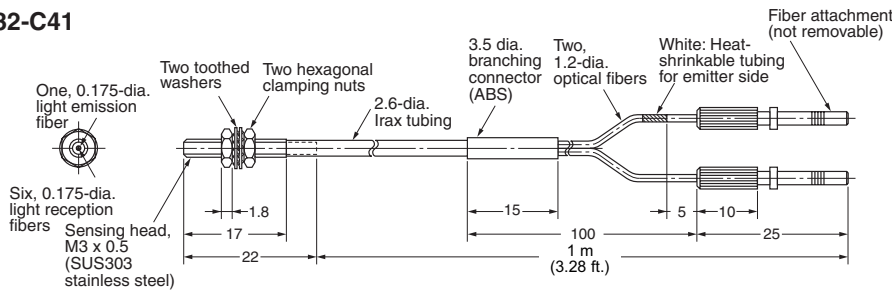

Unit: mm (inch)

E32-C42

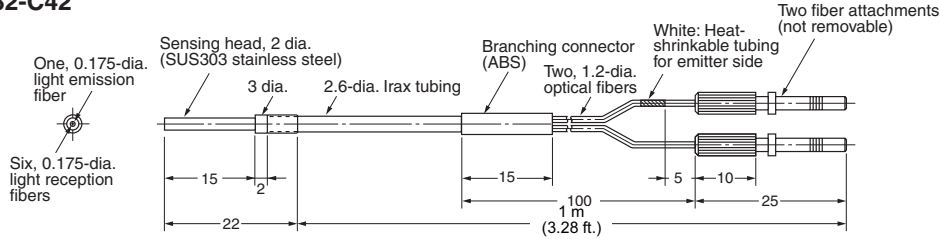

E32-D32 (Free-cut)

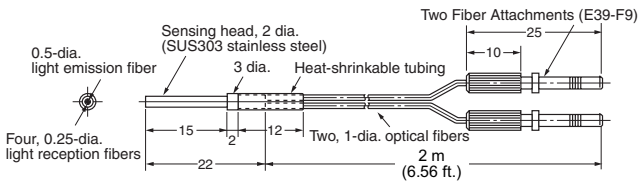

Note: The fiber for the emitter is identified by a white line.

E32-D14L (Free-cut)
E32-D14LR

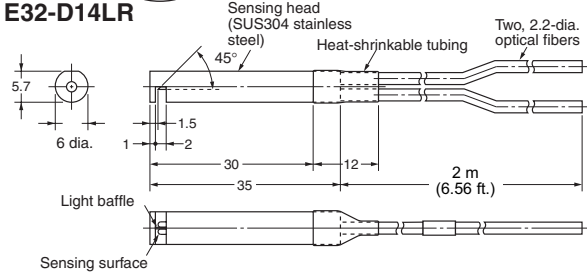

E32-D24 (Free-cut)
E32-D24R

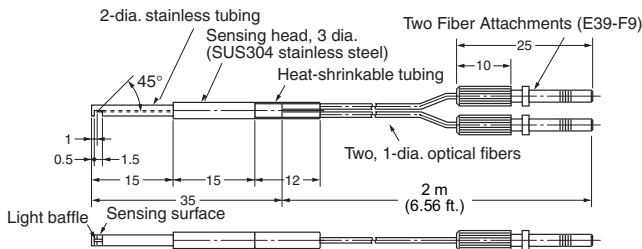

E32-D12F (Free-cut)

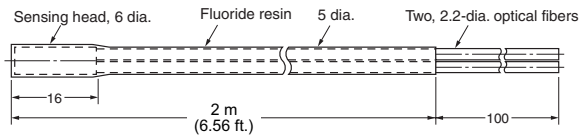

E32-D51 (Free-cut)

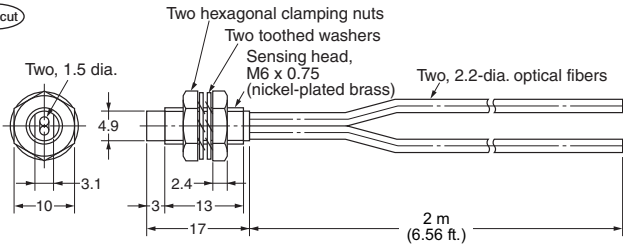

Note: Resistant temperature is 150°C.
Resistant temperature is 130°C when used continuously.

E32-D61

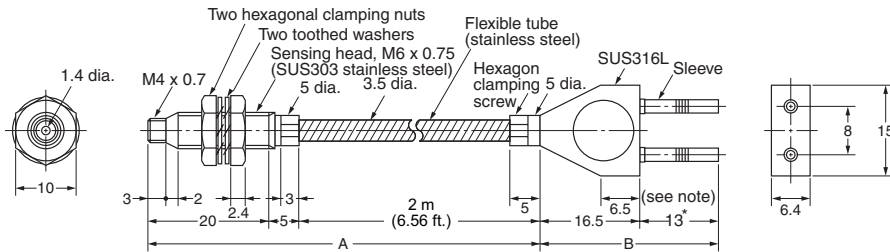

Note: Section A resists 300°C and section B (which is inserted to the Amplifier) resists 110°C. The operating temperature of the section to be inserted into the Sensor (marked with *) must be within the operating temperature range of the Amplifier.

E32-D73

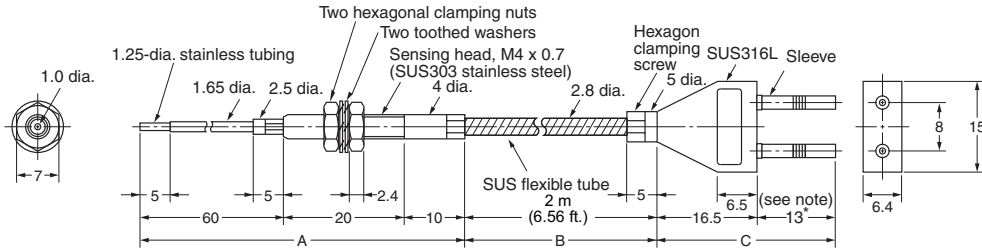

Note: Section A resists 400°C, section B resists 300°C, and section C (which is inserted to the Amplifier) resists 110°C. The operating temperature of the section to be inserted into the Sensor (marked with *) must be within the operating temperature range of the Amplifier.

E32-D36P1

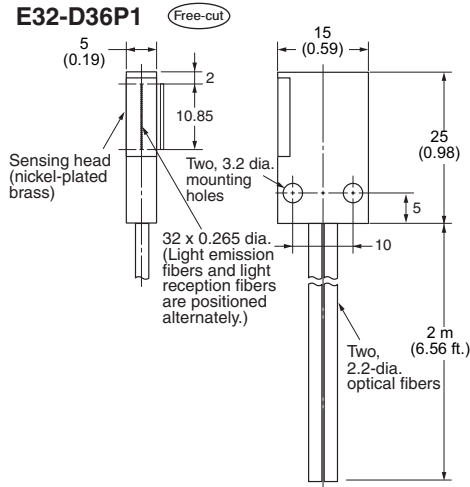

Mounting Holes

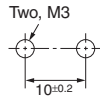

E32-R21
(One E39-R3 Reflector is Supplied with the Sensor)

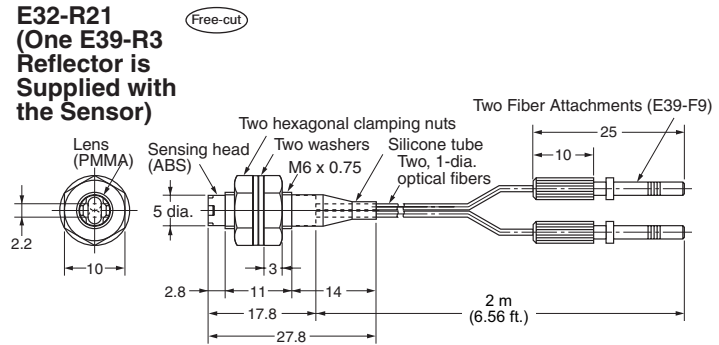

E32-R16
(One E39-R1 Reflector is Supplied with the Sensor)

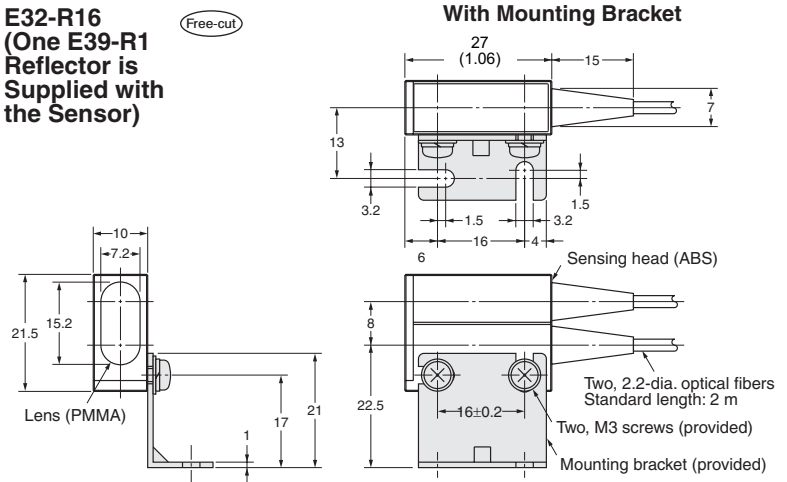

With Mounting Bracket

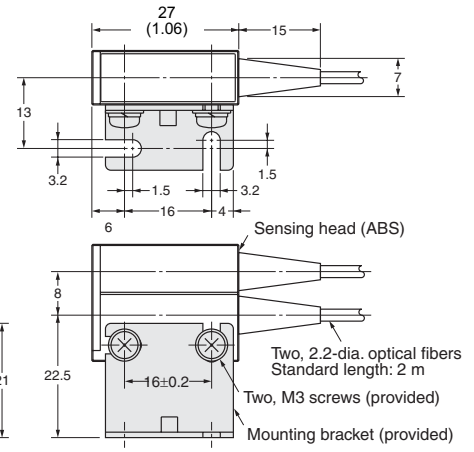

E32-L56E1
E32-L56E2

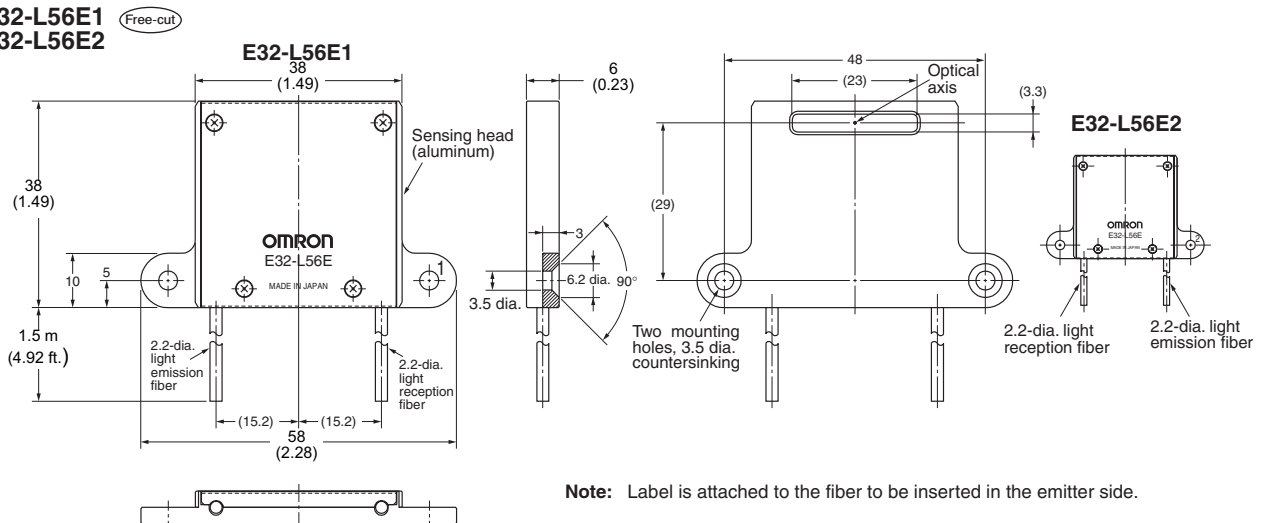

Note: Label is attached to the fiber to be inserted in the emitter side.

Unit: mm (inch)

E32-L24L (Free-cut)

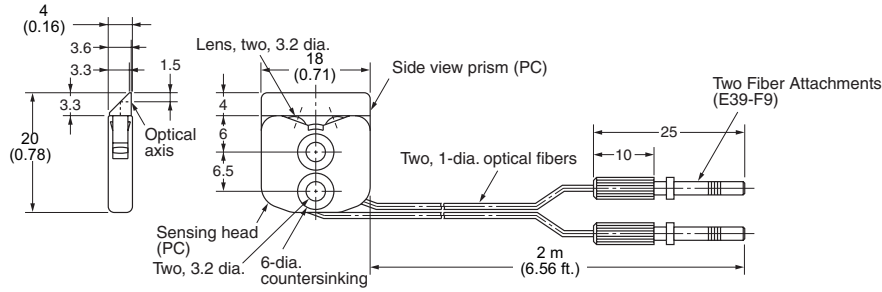

E32-L25L (Free-cut)

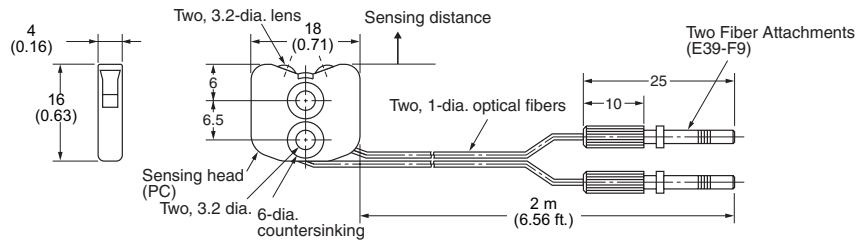

E32-L25 (Free-cut)

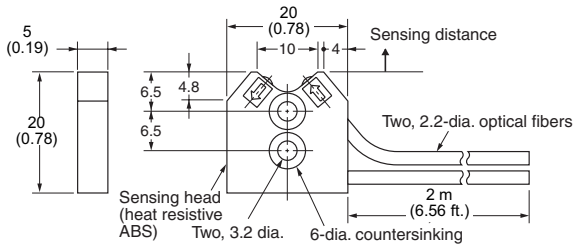

Note: The fiber for the emitter is identified by a white line.

E32-L25A (Free-cut)

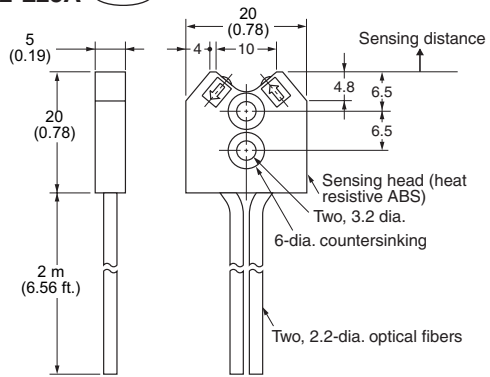

Note: The fiber for the emitter is identified by a white line.

Accessories (Order Separately)

Reflectors

Reflector E39-R1



Material:
Reflective surface: acrylic
Back: ABS

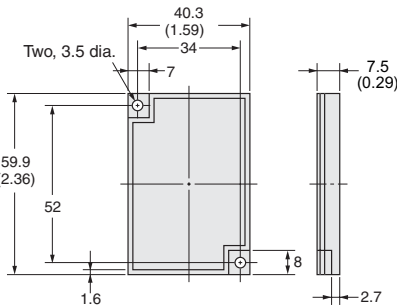

Reflector (Miniature) E39-R3



Material:
Reflective surface: acrylic
Back: ABS

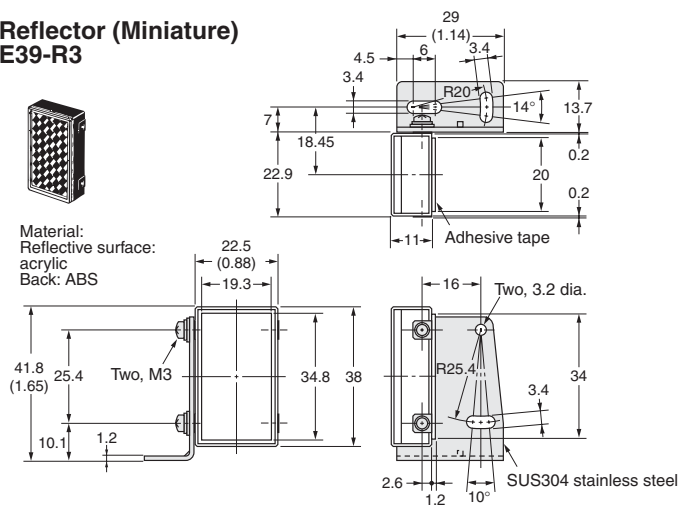

E39-L4

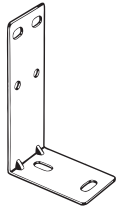

Material: iron

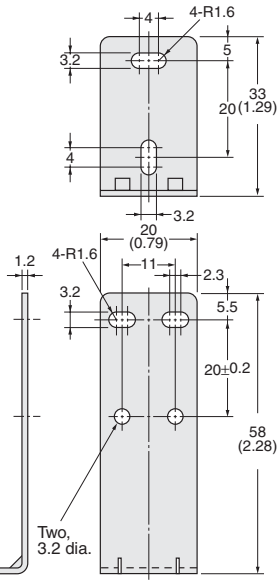

E39-L94

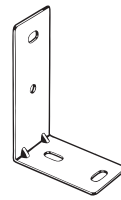

Material: iron

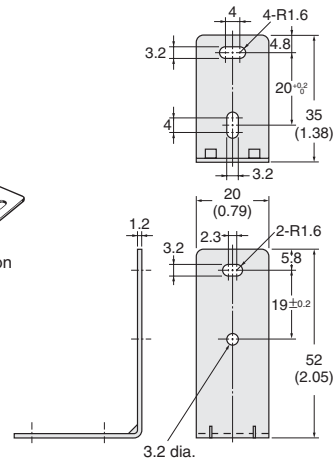

Lens Units

E39-F1 Long Distance Lens Unit



Material: Tube: Brass
Lens: Optical glass

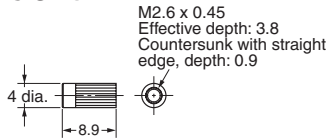

Note: One set includes two units.

E39-F2 Side-view Unit



Material: Tube: Brass
Lens: Optical glass

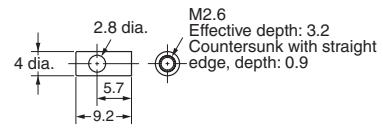

Note: One set includes two units.

E39-F3 Lens-equipped Reflective Unit

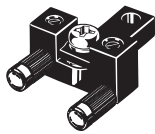

Material: Tube: Brass
Base: Aluminum

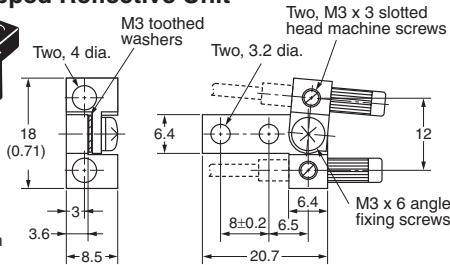

Note: Fix the fiber head using the slotted head machine screw. Do not insert the E39-F1 Lens.

E39-F5 Side-view Reflective Unit

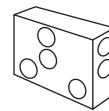

Material: Base: Brass
Reflector: Stainless steel

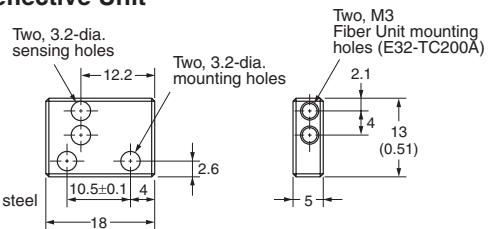

Note: Only E32-TC200A can be mounted. When mounting, remove all of the accompanying screws first and then screw the E32-TC200A into the E39-F5 until the stopper comes into contact.

**E39-F3A
Small Spot Lens Unit**

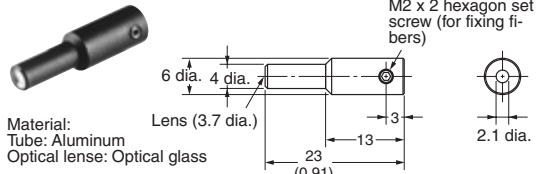

Material:
Tube: Aluminum
Optical lens: Optical glass

Note: E39-F3A is a Lens Unit for the E32-D32 and E32-C42.

**E39-F3A-5
Small Spot Lens Unit**

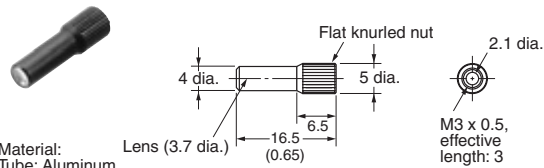

Material:
Tube: Aluminum
Optical lens: Optical glass

Note: E39-F3A-5 is a Lens Unit for the E32-C31 and E32-C41.

**E39-F3B
Small Spot Lens Unit**

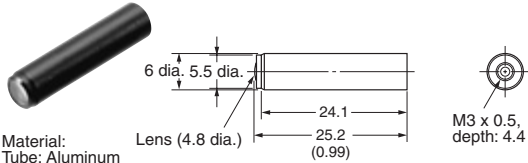

Material:
Tube: Aluminum
Optical lens: Optical glass

Note: E39-F3B is a Lens Unit for the E32-C31 and E32-C41.

**E39-F3C
Small Spot Lens Unit**

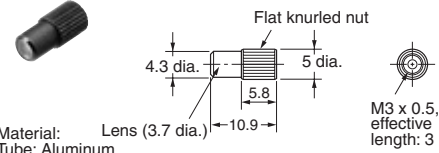

Material:
Tube: Aluminum
Optical lens: Optical glass

Note: E39-F3C is a Lens Unit for the E32-C31 and E32-C41.

Protective Spiral Tubes

**E39-F32A, E39-F32A5
E39-F32B, E39-F32B5**

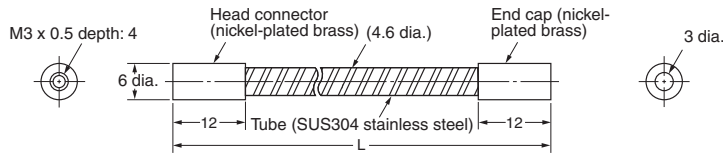

Note: 1. L is as follows:
E39-F32A and E39-F32B: 1m (3.28 ft)
E39-F32A5, E39-F32B5: .5m (1.64 ft)
2. A pair of E39-F32A(5)'s is sold as E39-F32B(5).

E39-F32C, E39-F32C5

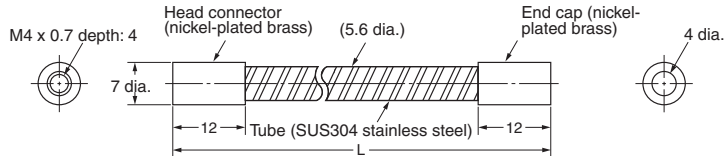
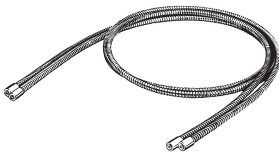

Note: L is as follows:
E39-F32C: 1m (3.28 ft)
E39-F32C5: .5m (1.64 ft)

E39-F32D, E39-F32D5

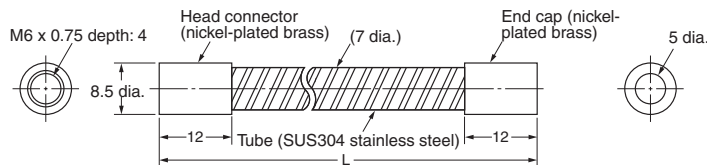
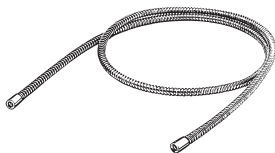

Note: L is as follows:
E39-F32D: 1m (3.28 ft)
E39-F32D5: .5m (1.64 ft)

Other Accessories

E39-F4 Fiber Cutter

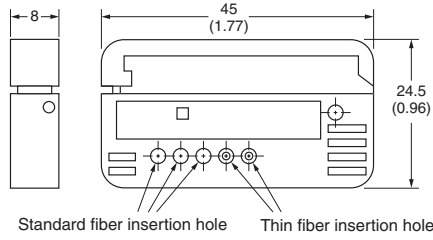
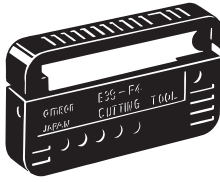

E39-F9 Attachment for Thin Fiber

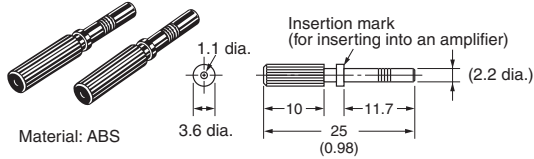

Material: ABS

Note: One set includes two units.
Included with Thin Fiber Unit.

E39-F10 Fiber Connector

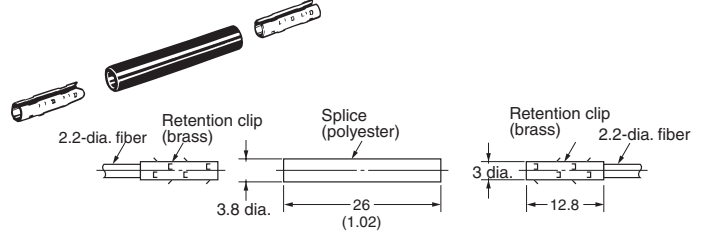

E39-F11 Sleeve Bender

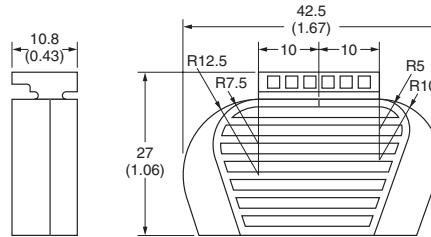

E39-K2 Protective Attachment



Material: ABS

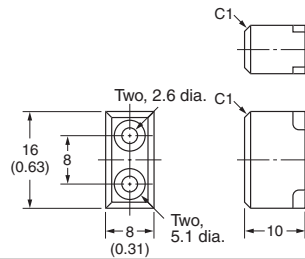

Application Example

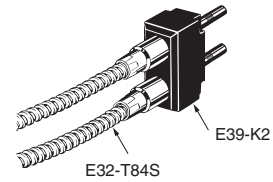

Installation

■ Connection

Connection with K3NX-VD2□ Process Meter

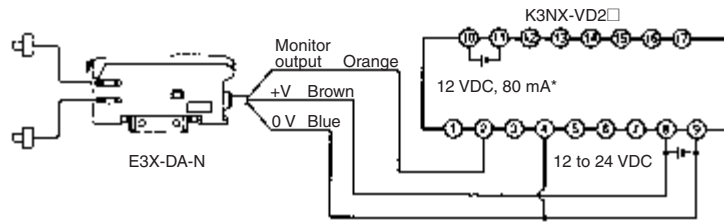

* Use this service power supply for the Sensor with reference to the power consumption of each Sensor.

- Note:**
1. Various I/O Units are available for the K3NX. Select an appropriate output type depending on the application.
 2. For details about the K3NX, refer to the K3NX Datasheet (N084) or the K3NX Operation Manual (N090).
 3. This wiring is for the K3NX with DC power supply specifications and the Monitor (Analog) Sensor with DC power supply specifications. Check respective power supply specifications before wiring them.

■ Mounting

Joining Amplifier Units

1. Mount the Amplifier Units one at a time onto the DIN rail.

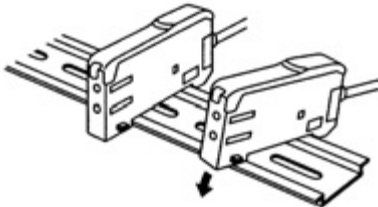

2. Line up the clips and slide the Amplifier Units together, and then press the units together until they click into place.

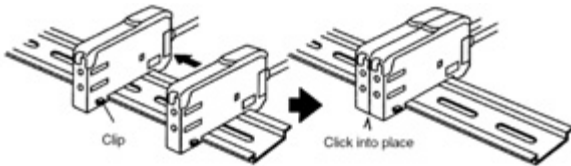

Mounting the Optical Communication Head

Allow 20 mm (0.79 in) of space to mount the Optical Communication Head on the DIN rail between a cabinet wall and the first Amplifier Unit. For proper operation, position the Optical Communication Head close to the nearest Amplifier Unit, so there is less than a 5 mm (0.20 in) gap.

Allow 20 mm (0.79 in) to mount the Optical Communication Head on DIN rail.

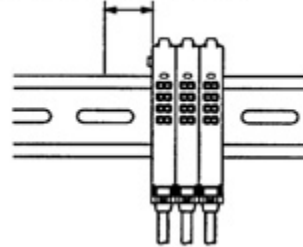

Separating Amplifier Units

Slide Amplifier Units away from each other, and remove from the DIN rail one at a time. (Do not attempt to remove Amplifier Units from the DIN rail without separating them first.)

- Note:**
1. The specifications for ambient temperature will vary according to the number of Amplifier Units used together. For details, refer to *Ratings/Characteristics*.
 2. Always turn OFF the power supply before joining or separating Amplifier Units.

Mounting

1. Mount the front part of the Amplifier Unit onto mounting bracket E39-L143 (included) or onto DIN rail.
2. Press the back part onto the mounting bracket or onto the DIN rail.

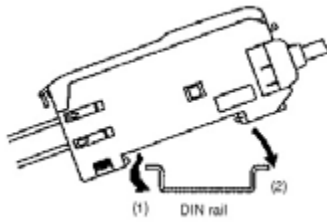

Removal

Pull the lock tab of the Amplifier Unit with a flat blade screwdriver in direction (3) and lift the fiber insertion part in direction (4) as shown below.

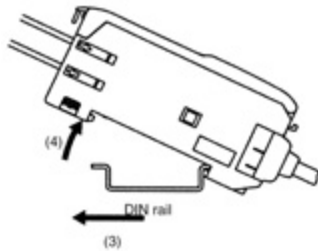

In the case of side mounting, attach the E39-L143 mounting bracket on the Amplifier Unit first, and secure the Amplifier Unit with M3 screws and washers. The diameter of the washers should be no more than 6 mm.

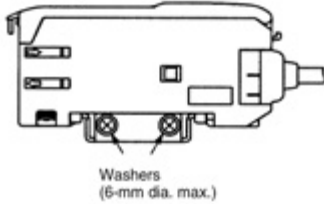

Fiber Unit

Mounting

Tightening Force

The tightening force applied to the sensing head should be as follows:

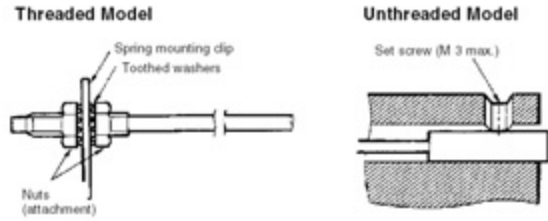

Sensing head	Tightening torque
M3/M4 screw	0.78 N • m max.
M6 screw/ 6-mm dia. column	0.98 N • m max.
1.5-mm dia. column	0.2 N • m max.
2-mm dia./3-mm dia. column	0.29 N • m max.
E32-T12F 5-mm dia. Teflon model	0.78 N • m max.
E32-D12F 6-mm dia. Teflon model	
E32-T16	0.49 N • m max.
E32-R21	0.59 N • m max.
E32-M21	Up to 5 mm to the tip: 0.49 N • m max. More than 5 mm from the tip: 0.78 N • m max.
E32-L25A	0.78 N • m max.
E32-T16P E32-T24S E32-L24L E32-L25L	0.29 N • m max.

Use a proper-sized wrench.



Fiber Connection and Disconnection

The E3X amplifier has a lock button. Connect or disconnect the fibers to or from the E3X amplifier using the following procedures:

1. Connection

Remove the protective cover, insert the fiber into the amplifier, and lower the lock button until a click is heard.

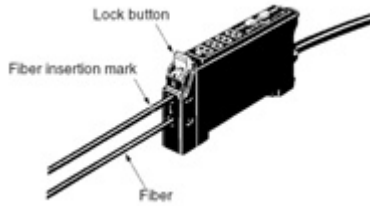

After cutting the fiber using the E39-F4 Fiber Cutter, put an insertion mark on the fiber as a guide for correct insertion into the amplifier, and then insert the fiber up to this mark.

2. Disconnection

Remove the protective cover and raise the lock button to pull out the fiber.

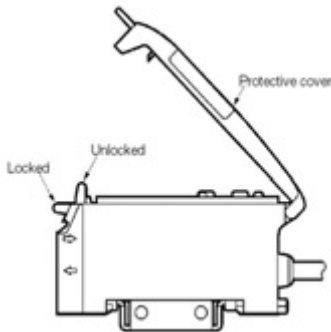

Note: Remove the protective cover and raise the lock lever to pull out the fiber. (Before removing the fiber, be sure to confirm that the lock is released so as to maintain the fiber properties.)

3. Precautions for Fiber Connection/Disconnection

Be sure to lock or unlock the lock button within an ambient temperature range between -10°C and 40°C .

■ Fiber Insertion

Make sure that the fiber is fully inserted in the amplifier. The sensing distance may decrease if the fiber is not fully inserted.

Standard 2.2-mm dia. Fiber

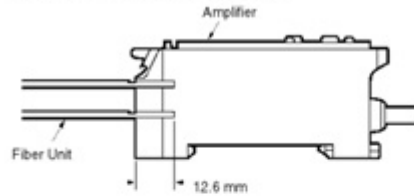

Thin Fiber with the E39-F9 Attachment

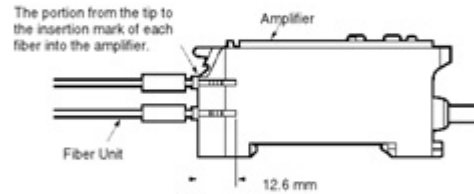

Fiber with Fixed Length

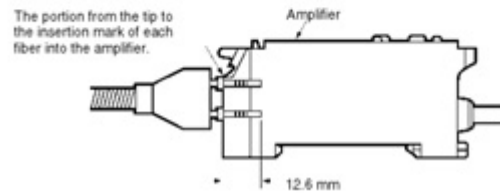

■ Cutting Fiber

Insert a fiber into the Fiber Cutter and determine the length of the fiber to be cut.

Press down the Fiber Cutter in a single stroke to cut the fiber.

An insertion mark can be placed on the fiber to serve as a reference when inserting the fiber into the amplifier. Use the following procedure.

Confirm through the cutter hole that the fiber is inserted beyond the insertion mark hole so that the insertion mark is properly indicated, and then press firmly down on the cutter.

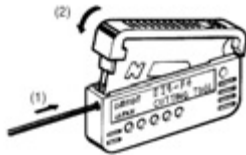

Insert the fiber into the amplifier up to the insertion mark. Proper fiber performance will not be achieved unless the fiber is inserted all the way to the insertion mark. (This method is applicable to standard, 2.2-mm dia. fibers only.)

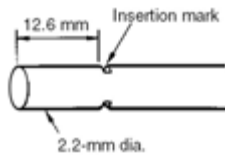

The cutting holes cannot be used twice. If the same hole is used twice, the cutting face of the fiber will be rough and the sensing distance will be reduced. Always use a new hole.

Use either one of the two holes on the right (refer to the following figure) to cut a thin fiber as follows:

1. An attachment is temporarily fitted to a thin fiber before shipment.

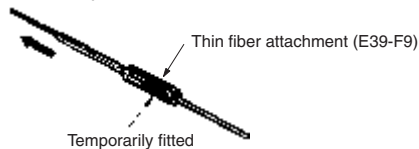

2. Secure the attachment after adjusting the position of the thin fiber in the direction indicated by the arrow.



3. Insert the fiber to be cut into the E39-F4.

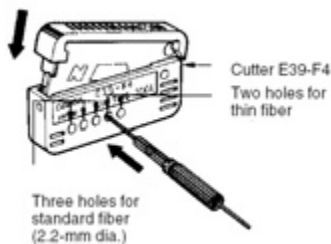

4. Finished state (proper cutting state)



Note: Insert the fiber in the direction indicated by the arrow.

Connection

Do not pull or press the fiber units. The fiber units have a withstand force of 9.8 N to 29.4 N (pay utmost attention because the fibers are thin).

Do not bend the fiber unit beyond the permissible bending radius.

Do not bend the edge of the fiber units (excluding the E32-T□R and E32-D□R).

Correct

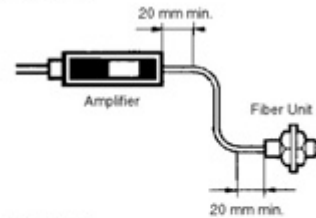

Incorrect

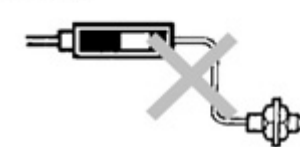

Note: Do not apply excess force on Fiber units.

Correct

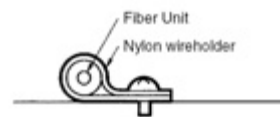

Incorrect



Excessive vibration can break the fiber head. Use the following method to prevent fiber head breakage.

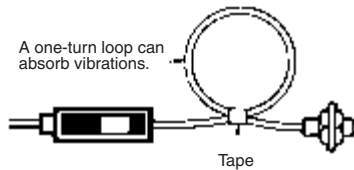

Bending Radius

E39-F11 Sleeve Bender

The bending radius of the stainless steel tube should be as large as possible. The smaller the bending radius becomes, the shorter the sensing distance will be.

Insert the tip of the stainless steel tube to the Sleeve Bender and bend the stainless steel tube slowly along the curve of the Sleeve Bender (refer to the figure).

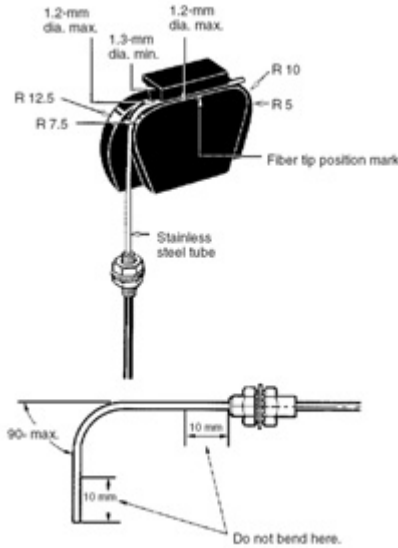

E39-F32 Protective Spiral Tubes

Insert a fiber to the protective spiral tube from the head connector side (screwed) of the tube.



Push the fiber into the protective spiral tube. The tube should be straight so that the fiber is not twisted when inserted. Then turn the end cap of the spiral tube.



Secure the protective spiral tube on a suitable place with the attached nut.

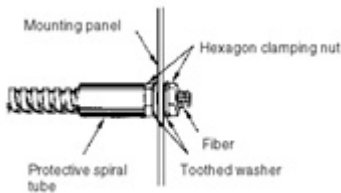

Use the attached saddle to secure the end cap of the protective spiral tube. To secure the protective spiral tube at a position other than the end cap, apply tape to the tube so that the portion becomes thicker in diameter.

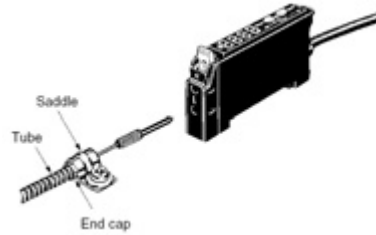

E39-F10 Fiber Connector

Mount the fiber connector as shown in the following illustrations

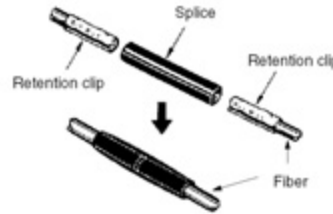

Each fiber unit should be as close as possible before they are connected.

Sensing distance will be reduced by approximately 25% when fibers are connected.

Only 2.2-mm dia. fibers can be connected.

Connectors

Mounting Connectors

1. Insert the Master or Slave Connector into the Amplifier Unit until it clicks into place.

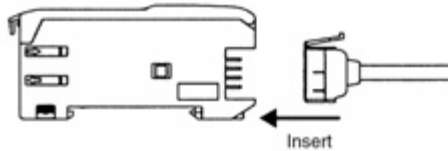

2. Join Amplifier Units together as required after all the Master and Slave Connectors have been inserted.
3. Attach the stickers (provided as accessories) to the sides of Master and Slave Connectors that are not connected to other Connectors.

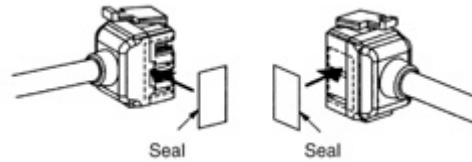

Note: Attach the stickers to the sides with grooves.

Removing Connectors

1. Slide the Amplifier Unit away from the rest of the group.
2. After the desired Amplifier Unit(s) has been separated from the group, press down on the Connector lever and remove it. (Do not attempt to remove Connectors without separating them from other Amplifier Units first.)

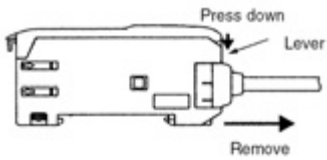

Mounting End Plate

Depending on how it is mounted, an Amplifier Unit may move during operation. In this case, use an End Plate.

Before mounting an End Plate, remove the clip from the Master Amplifier Unit using a nipper or similar tool.

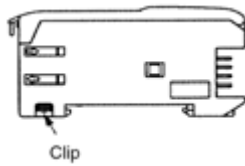

The clip can also be removed using the following mechanism, which is incorporated in the construction of the section underneath the clip.

1. Insert the clip that is to be removed into the slit underneath the clip on another Amplifier Unit.

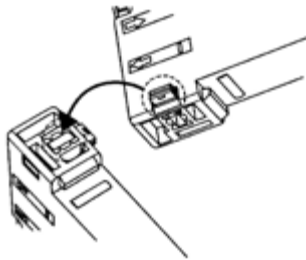

2. Remove the clip by rotating the Amplifier Unit.

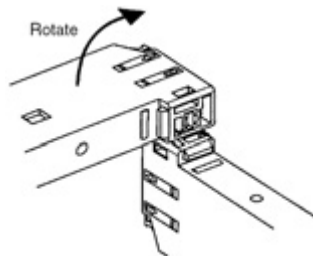

When using the E3X-DA-N with the Remote Control Programmer, mount the End Plate in the way shown below.

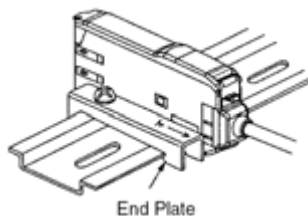

Pull Strength for Connectors (Including Cables)

E3X-CN11, E3X-CN21, E3X-CN22: 30 N max.
E3X-CN12: 12 N max.

Precautions

■ Avoid damage to the E3X-DA-N

- Voltage must not exceed the rated voltage of the E3X-DA-N.
- When supplying power to the E3X-DA-N, make sure that the polarity of the power is correct.
- Do not short-circuit the load connected to the E3X-DA-N.
- Do not impose 100 VAC or more on models that operate with DC.
- Do not use the E3X-DA-N in environments where flammable or explosive gas exists.
- Do not disassemble, repair or modify the E3X-DA-N.
- The E3X-DA-N has an enclosure rating of IP50; do not immerse in water.
- Load must be connected to the E3X-DA-N.

■ Installation

Power Reset Time

- The E3X-DA-N is ready to sense objects 200 ms after the power supply is turned on.
- If power is supplied to the E3X-DA-N and the load independently, make sure to turn ON the E3X-DA-N first.
- When the E3X-DA-N is turned ON or OFF, the operation indicator will be illuminated for an instant, but no control output will be turned ON.

Power Supply

- Do not connect the E3X-DA-N to a full-wave or half-wave rectified power supply.
- When a standard switching power supply is used, the frame ground (FG) and the ground (G) terminal must be grounded. Otherwise, the E3X-DA-N may experience noise problem.

■ Wiring

Cable

- The cable can be extended up to 100 m provided the wire thickness is at least 0.3 mm².
- Do not pull cables with pulling force exceeding 50N.

Avoid Damage or Malfunction Due to Induction Noise

- Never run the E3X-DA-N cables in the same conduit with power lines or high tension cables.

■ Adjustment

Mutual Interference Protection Function

There may be some instability in the digital display values due to light from other sensors. If this occurs, increase the sensitivity (i.e., decrease the threshold) to perform stable detection.

EEPROM Writing Error

If the data is not written to the EEPROM correctly due to a power failure during teaching or static-electric noise, repeat the whole teaching procedure.

Optical Communications

Several Amplifier Units can be slid together and used in groups. Do not, however, slide the Amplifier Units or attempt to remove any of the Amplifier Units during operation.

Hysteresis Adjustment

The hysteresis setting can be adjusted using the Remote Control Programmer. Do not, however, set the hysteresis to a value lower than the factory setting. Using a setting less than the factory setting may result in incorrect operation.

■ Typical Values

Minimum sensing object and characteristic data values are typical values checked on actual products selected at random. None of these values represent a guaranteed rating or performance value.

ALL DIMENSIONS SHOWN ARE IN MILLIMETERS. To convert millimeters into inches, divide by 25.4

OMRON

OMRON ELECTRONICS LLC

One East Commerce Drive
Schaumburg, IL 60173

1-800-55-OMRON**OMRON ON-LINE**

Global - <http://www.omron.com>
USA - <http://www.omron.com/oei>
Canada - <http://www.omron.com/oci>

OMRON CANADA, INC.

885 Milner Avenue
Toronto, Ontario M1B 5V8

416-286-6465