

Digital Radio Receiver Down Converter Modules for 21.2 to 23.6 GHz

Technical Data

DRR1-23XX

Features

- **Low Noise PHEMT MMIC Front End Amplifier**
- **Image Reject Mixer**
- **Integrated Silicon Bipolar VCO Local Oscillator**
- **Low Phase Noise**
- **Operated Over -30°C to +70°C**
- **Excellent Tuning Linearity**
- **Sample Output for Phase Locking**

Description

This digital radio receiver module provides the RF receive and down conversion function for 23 GHz digital radios. These modules offer excellent phase noise performance and can be easily phase locked to a frequency reference. The receiver module provides an output power of 3 dBm at the IF frequency and is ideal for use in radios using 2 and 4 level FSK modulation. The excellent low noise figure is achieved by using the Hewlett-Packard PHEMT MMIC technology coupled with an image reject mixer. The receiver module features an integrated ultra low noise silicon bipolar

VCO operating in the S/C band as the local oscillator. A portion of the oscillator output is coupled off and is applied to a frequency divider network. The low frequency output from the frequency divider can then be easily used to phase lock the source. The local oscillator output is applied to a frequency multiplier network to produce the desired LO frequency to the mixer.

Applications

This digital radio receiver module provides the total RF receive and down conversion function in radios operating in the 21.2 to 23.6 GHz band.

Block Diagram

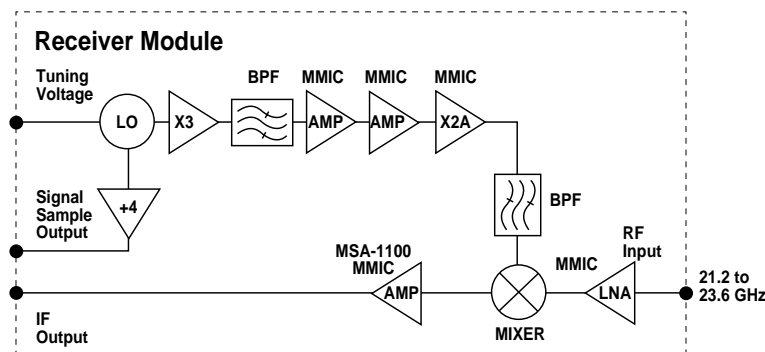

DRR1-23XX Absolute Maximum Ratings ($T_A = -30$ to $+70^\circ\text{C}$)

Parameters	Units	Ratings
DC Circuit Power +8.5	Volts	10
+5.0	Volts	+5.5
-5.0	Volts	-5.5
Tuning Voltage	Volts	14

Notes:

1. Operation in excess of any one of these parameters may result in permanent damage.
2. A thermal interface medium must be used between the bottom of the package and its mating surface to ensure optimum heat transfer.

DRR1-23XX Electrical Characteristics

Parameters	Units	Min.	Typ.	Max.
RF Tuning Range	GHz	21.2		23.6
IF Frequency	MHz	630 or 1260		
IF Bandwidth	MHz	± 20		
LO Frequency	GHz	20.57 or 19.94		22.97 or 22.34
Gain	dB	18		26
Gain Flatness over 300 MHz	dB			± 1
Noise Figure	dB		4.5	5.5
Operating Temperature Range	$^\circ\text{C}$	-30		70
Storage Temperature Range	$^\circ\text{C}$	-45		85
Power Input at P-1dB	dBm	-22	-17	
LO Leakage at I ^[1]	dBm			-15
LO Leakage at R ^[2]	dBm			-15
Return Loss RF Port	dB	12		
Return Loss IF Port	dB	14		
Image Rejection	dB	12	15	
Sample Out Frequency	MHz	857 or 831		957 or 931
Sample Out Power	dBm	-10		0
Spurious Output ^[3]	dBc			-60
Phase Noise @ 100 KHz	dBc/Hz		-85	-82
Tuning Voltage	V	1		12
Input Capacitance, Nom	pf		1,000	
LO Tuning Sensitivity	MHz/V		300	500
LO Tuning Sensitivity Variation			1.5 : 1	2.0:1
DC Circuit Power: 8.5 Volts	mA			300
5 Volts	mA			400
-5 Volts	mA			30
Case Dimensions	inches	3.5 x 1.25 x 0.40		
Max Power at Input/no damage	dBm			10
Humidity Non Condensing	%		85	
Condensing	%		95	
Connectors		WR 42 or SMA		

Notes:

1. LO and Harmonic/sub-harmonic leakage at I with RF terminated into a 50 Ω load.
2. LO and Harmonic/sub-harmonic leakage at R up to 50 GHz.
3. Measured at IF port within the IF bandwidth with single tone RF input of < -20 dBm.

DRR1-23XX Typical Performance

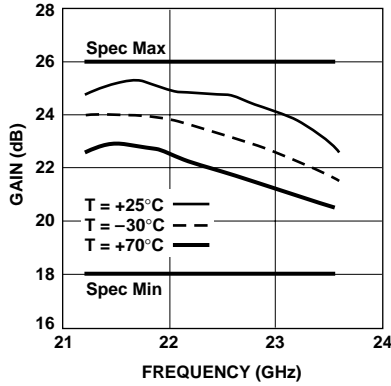

Figure 1. Conversion Gain vs. Frequency.

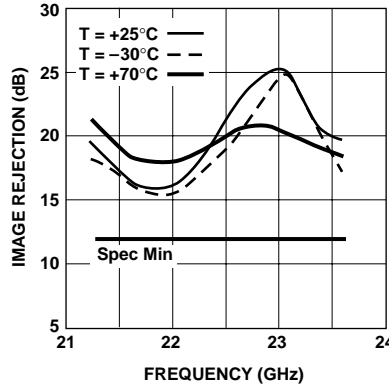

Figure 2. Image Rejection vs. Frequency.

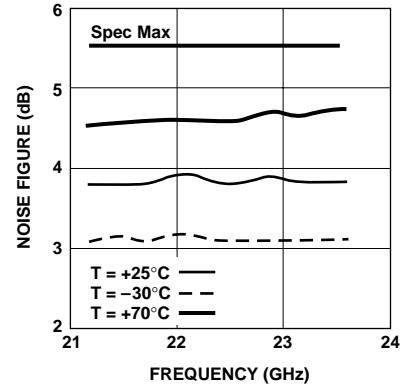

Figure 3. Noise Figure vs. Frequency.

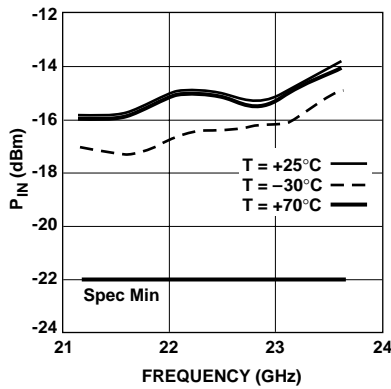

Figure 4. Power In at P_{1dB} Out vs. Frequency.

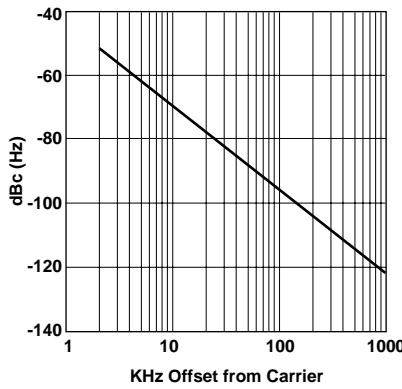

Figure 5. Phase Noise at 23 GHz vs. KHz Offset from Carrier.

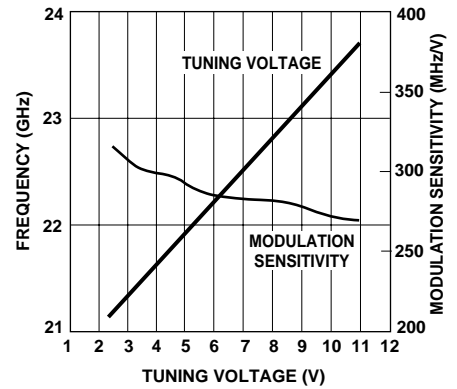

Figure 6. Tuning Voltage vs. Frequency and Modulation Sensitivity.

Powering Up Instructions

The -5 volts must be applied to the receiver module **before** applying the +5 volts. Likewise when shutting down the receiver module the +5 volts must be removed before the -5 volts is

turned off. The +8.5 volts can be turned on in any sequence. Failure to follow this procedure could cause permanent damage to the module.

Mounting Instructions

Case must be mounted firmly, with screws, to an adequate metallic structure that has sufficient thermal properties to maintain the module case at a temperature not to exceed 70°C.

Product Options

Specify part number followed by option. For example:

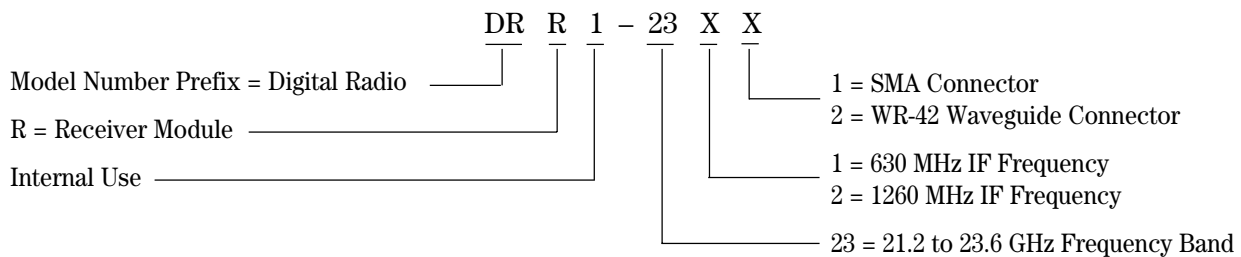

Case Dimensions (specified in inches)

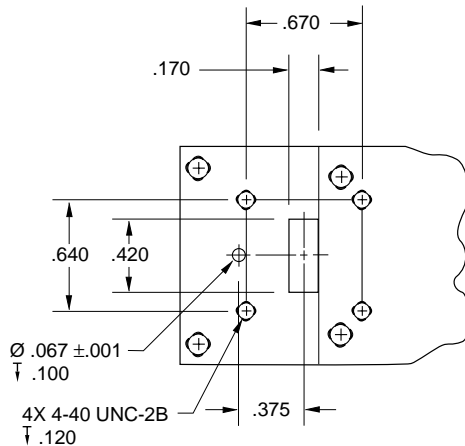
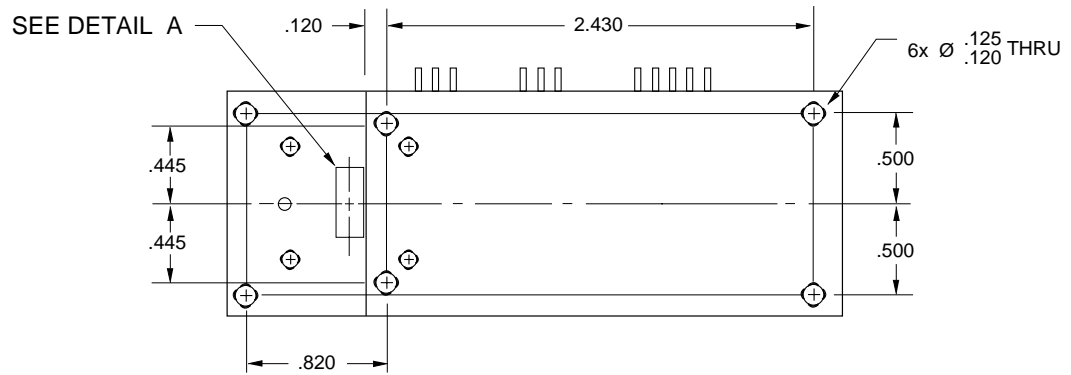
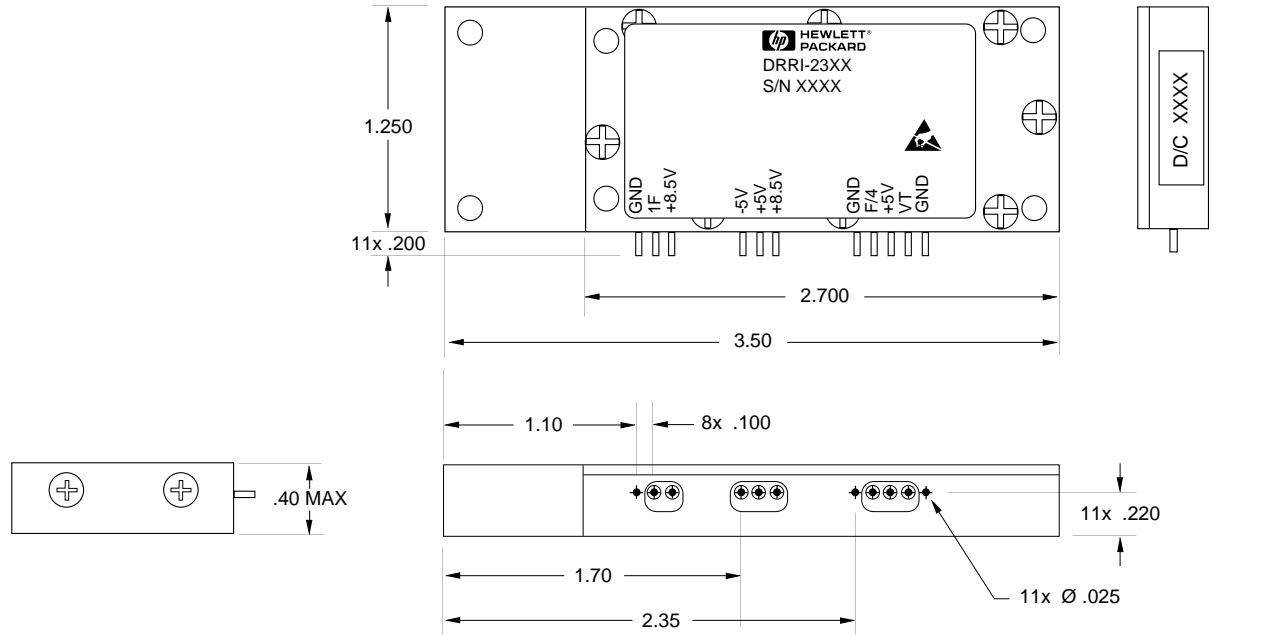

DETAIL A

For technical assistance or the location of your nearest Hewlett-Packard sales office, distributor or representative call:

Americas/Canada: 1-800-235-0312 or 408-654-8675

Far East/Australasia: Call your local HP sales office.

Japan: (81 3) 3335-8152

Europe: Call your local HP sales office.

Data subject to change.
Copyright © 1997 Hewlett-Packard Co.

Printed in U.S.A. 5965-5087E (5/97)