

**PLEASE CHECK WWW.MOLEX.COM FOR LATEST PART INFORMATION**

**Part Number:** [0003096061](#)  
**Status:** **Active**  
**Overview:** [standard\\_093](#)  
**Description:** 2.36mm (.093") Diameter Standard .093 Pin and Socket Receptacle Housing, 6 Circuits, Dual Row, Panel Mount, Black

**Documents:**

<a href="#">3D Model</a>	<a href="#">Product Specification PS-02-09 (PDF)</a>
<a href="#">Packaging Specification (PDF)</a>	<a href="#">Product Specification PS-43660-9999 (PDF)</a>
<a href="#">Drawing (PDF)</a>	<a href="#">RoHS Certificate of Compliance (PDF)</a>

**Agency Certification**

CSA	LR19980
UL	E29179

**General**

Product Family	Crimp Housings
Series	<a href="#">1261</a>
Comments	14.0A max. can be achieved when housing is used with 42477 or 42478 terminals
Overview	<a href="#">standard_093</a>
Product Name	Standard .093"

**Physical**

Circuits (maximum)	6
Color - Resin	Natural
Flammability	94V-2
Gender	Male
Glow-Wire Compliant	No
Lock to Mating Part	Yes
Material - Resin	Nylon
Number of Rows	2
Packaging Type	Bag
Panel Mount	Yes
Pitch - Mating Interface (in)	0.198 In
Pitch - Mating Interface (mm)	5.03 mm
Stackable	No
Temperature Range - Operating	-40°C to +105°C

**Electrical**

Current - Maximum per Contact	11A
-------------------------------	-----

**Material Info**

Old Part Number	1261RBK
-----------------	---------

**Reference - Drawing Numbers**

Packaging Specification	PK-1261-001
Product Specification	PS-02-09, PS-43660-9999
Sales Drawing	SD-1261-*

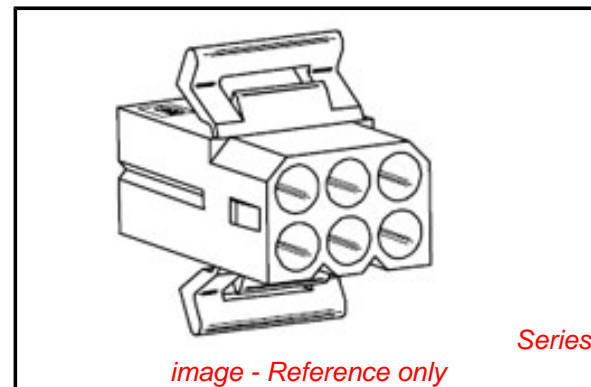

image - Reference only

**EU RoHS**

**ELV and RoHS Compliant**

**REACH SVHC**

Not Reviewed

**Halogen-Free**

**Status**

**Not Reviewed**

**Need more information on product environmental compliance?**

Email [productcompliance@molex.com](mailto:productcompliance@molex.com)  
 For a multiple part number RoHS Certificate of Compliance, [click here](#)

Please visit the [Contact Us](#) section for any non-product compliance questions.

**China RoHS**



**Search Parts in this Series**

[1261Series](#)

**Mates With**

[03-09-7062](#) , [3099](#)

**Use With**

[1189](#) Crimp Terminals, [1190](#) Crimp Terminals, [1376](#) Male PC Tail Terminals, [1377](#) Female PC Tail Terminals, [1380](#) Male Crimp Terminals, [1381](#) Female Crimp Terminals, [1433](#) Crimp Terminals, [1434](#) Male Crimp Terminals, [2151](#) , [2870](#) , [2871](#) , [4550](#) , [6271](#) , [42477](#) , [42478](#)

13 12 11 10 9 8 7 6 5 4 3 2 1

J  
I  
H  
G  
F  
E  
D  
C  
B  
A

J  
I  
H  
G  
F  
E  
D  
C  
B  
A

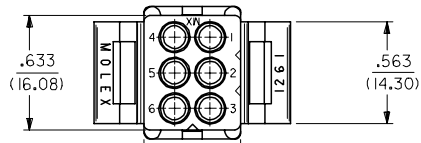

CIRCUIT I.D. (3 PL.)

OPTIONAL MOUNTING EAR (PREBENT SHOWN) & RIB, SEE DETAIL 3 & 4

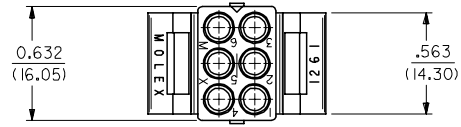
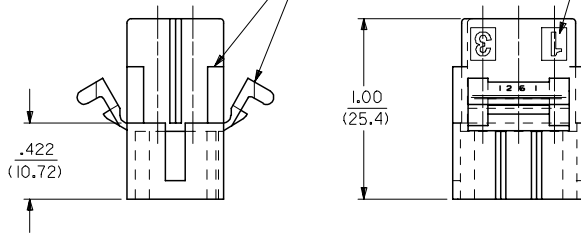

OPTIONAL MOUNTING EAR (PREBENT SHOWN) SEE DETAIL 3 & 4

OPTIONAL LOCK RAMP

CIRCUIT I.D. (3 PL.)

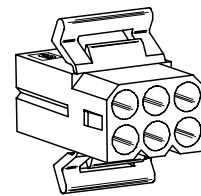
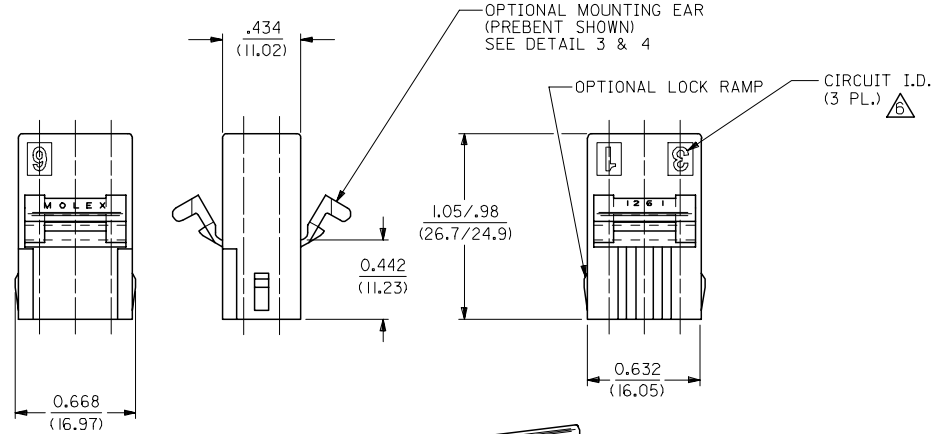

RECEPTACLE

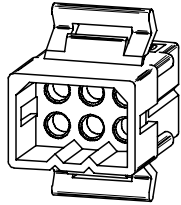
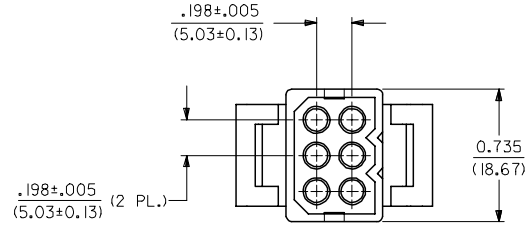

PLUG

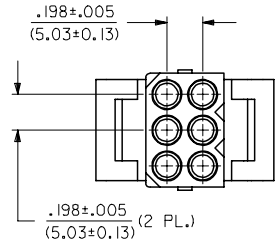

<b>REVISED NOTES</b> EC NO: UCP2006-2424 DRAWN/PRD/DR 2006/06/08 CHKD: AEL/HAG 2006/06/08 APPR: FSM/TH 2006/06/09	<b>QUALITY SYMBOLS</b> ▽=0 ▽=0	<b>GENERAL TOLERANCES (UNLESS SPECIFIED)</b>		<b>DIMENSION STYLE</b> IN/MM		SCALE 2:1	DESIGN UNITS INCH	THIRD ANGLE PROJECTION	
		mm	INCH	DRAWN BY	DATE	TITLE			
		4 PLACES ± .005	± .005	GWC	11/6/89	.093/(2.36) HOUSING, PLUG AND RECEPTACLE, 6 CKT., .198/(5.03)CTRS.			
		3 PLACES ± .007	± .007	CHECKED BY	DATE	MOLEX INCORPORATED			
2 PLACES ± 0.18	± 0.10	RW	11/6/89	APPROVED BY		DATE	MATERIAL NO. DOCUMENT NO. SHEET NO.		
1 PLACE ± 0.25	± .005	GWF	11/6/89	GWF		11/6/89	SD-1261-* 1 OF 2		
ANGULAR ± 2 °		DRAFT WHERE APPLICABLE MUST REMAIN WITHIN DIMENSIONS		SEE CHART		THIS DRAWING CONTAINS INFORMATION THAT IS PROPRIETARY TO MOLEX INCORPORATED AND SHOULD NOT BE USED WITHOUT WRITTEN PERMISSION			

12 11 10 9 8 7 6 5 4 3 2 1

**PLUG**

PART NO.	ENG. NO.
03-09-2061	I261-P
23-09-2061	I261-P-100
03-09-2062	I261-P1
23-09-2062	I261-P1-100
03-09-7061	I261-PBK
03-09-7062	I261-PIBK
27-09-2093	I261-PI-200
50-29-0099	I261-PI-300

**RECEPTACLE**

PART NO.	ENG. NO.
03-09-1061	I261-R
23-09-1061	I261-R-100
03-09-1062	I261-R1
23-09-1062	I261-R1-100
03-09-1063	I261-R2
23-09-1063	I261-R2-100
03-09-1064	I261-R3
27-09-1063	I261-R2-200
03-09-6064	I261-R3BK
03-09-6063	I261-R2BK
03-09-6062	I261-RIBK
03-09-6061	I261-RBK
50-29-1500	I261-R3-300

**LEGEND: PLUG**

I261-P\*\*\*-\*\*\*  
 P = PLUG  
 BLANK = PLUG WITH PREBENT MOUNTING EARS  
 I = PLUG WITHOUT MOUNTING EARS  
 COLOR: BLANK=NATURAL COLOR  
 AM=AMBER BK=BLACK BU=BLUE  
 BN=BROWN GY=GRAY GN=GREEN  
 OR=ORANGE RD=RED YW=YELLOW  
 MATERIAL: BLANK = NYLON 6/6, U.L. 94V-2  
 100 = POLYPROPYLENE, U.L. 94V-0  
 200 = NYLON 6/6, U.L. 94V-0, RED  
 300 = NYLON 6/6, U.L. 94V-2, BLACK  
 UV RESISTANT

**LEGEND: RECEPTACLE**

I261-R\*\*\*-\*\*\*  
 R = RECEPTACLE  
 BLANK = WITH STD. MOUNTING EARS, WITH LOCK RAMP  
 1 = WITH STD. MOUNTING EARS, WITHOUT LOCK RAMP  
 2 = WITHOUT MOUNTING EARS, WITHOUT LOCK RAMP  
 3 = WITHOUT MOUNTING EARS, WITH LOCK RAMP  
 4 = WITH PREBENT MOUNTING EARS, WITH LOCK RAMP  
 5 = WITH PREBENT MOUNTING EARS, WITHOUT LOCK RAMP  
 COLOR: BLANK=NATURAL COLOR  
 AM=AMBER BK=BLACK BU=BLUE  
 BN=BROWN GY=GRAY GN=GREEN  
 OR=ORANGE RD=RED YW=YELLOW  
 MATERIAL: BLANK = NYLON 6/6, U.L. 94V-2  
 100 = POLYPROPYLENE, U.L. 94V-0  
 200 = NYLON 6/6, U.L. 94V-0, RED  
 300 = NYLON 6/6, U.L. 94V-2, BLACK  
 UV RESISTANT

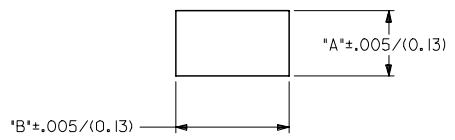
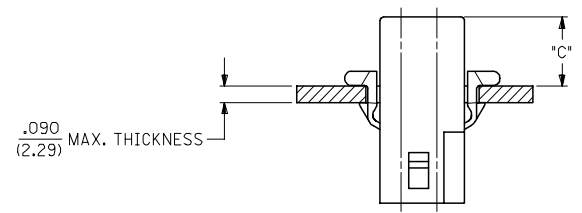

**MOUNTING HOLE CUTOUT**

HOUSING	DIM. "A"	DIM. "B"	DIM. "C" (STD. EAR)	DIM. "C" (PREBENT)
PLUG	.750/(19.05)	.695/(17.65)	.39/(9.9)	.40/(10.1)
RECEPTACLE	.718/(18.24)	.600/(15.24)	.40/(10.1)	.41/(10.3)

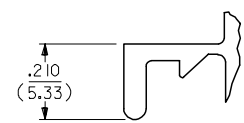

**DETAIL 3**

.093/(2.36) STANDARD MOUNTING EAR  
 (SCALE 4:1)

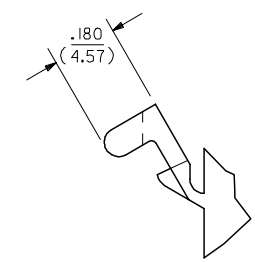
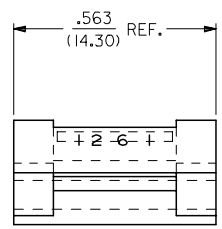

**DETAIL 4**

.093/(2.36) PREBENT MOUNTING EAR  
 (SCALE 4:1)

**NOTES:**

- MATERIAL: SEE LEGEND
- FINISH: NONE
- PRODUCT SPECIFICATION: PS-43660-9999
- PACKAGING INFORMATION: PK-1261-001
- HOUSINGS FOR USE WITH MOLEX .093/(2.36) PIN AND SOCKET TERMINALS.
- CIRCUIT I.D. NUMBERS ON SIDE OF HOUSING APPEAR ON PARTS FROM TOOLS BUILT AFTER 9/3/91.
- WHERE DENOTED IN CHART, TOOLS ARE BUILT WITH PREBENT MOUNTING EARS PER DETAIL 4 AND SUPERSEDE ALL TOOLS PREVIOUSLY BUILT WITH THE STANDARD MOUNTING EAR.
- TEXT AND CIRCUIT IDENTIFIERS ARE SHOWN IN APPROXIMATE LOCATION BUT MAY VARY TO ACCOMMODATE TOOLING.

UPDATED NOTES EC NO: UCP2006-2424 DRAWN: P11DDE 2006/06/08 CHKD: AELHAG 2006/06/08 APPR: FSM TH 2006/06/09 X3	QUALITY SYMBOLS ▽=0 ▽=0	GENERAL TOLERANCES (UNLESS SPECIFIED)		DIMENSION STYLE IN/MM		SCALE 4:1	DESIGN UNITS INCH	THIRD ANGLE PROJECTION		
		4 PLACES ± .005 ± .007 3 PLACES ± .007 ± .010 2 PLACES ± 0.18 ± .010 1 PLACE ± 0.25 ± .010	mm INCH	DRAWN BY GWF	DATE 11/10/89	CHECKED BY RW	DATE 11/10/89	.093/(2.36) HOUSING, PLUG AND RECEPTACLE, 6 CKT., .198/(5.03) CTRS.		
		ANGULAR ± 2 °		APPROVED BY GWF	DATE 11/10/89	MATERIAL NO. SEE CHART		DOCUMENT NO. SD-1261-*	SHEET NO. 2 OF 2	
		DRAFT WHERE APPLICABLE MUST REMAIN WITHIN DIMENSIONS		SIZE C		THIS DRAWING CONTAINS INFORMATION THAT IS PROPRIETARY TO MOLEX INCORPORATED AND SHOULD NOT BE USED WITHOUT WRITTEN PERMISSION				