

3 AMP DC-TO-DC MICROCONVERTER

LSH-6335
LSH-6435

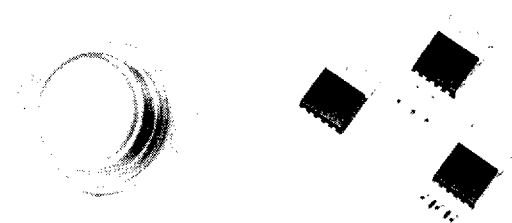

FEATURES

- Military temperature range
- Complete DC-to-DC converter
- 70% minimum efficiency
- 80kHz switching frequency
- Programmable output voltage from 5 to 31 Volts
- Preset output voltage of 5.05 Volts $\pm 1.5\%$
- Current limit and thermal shutdown
- Inhibit/enable control pin

DESCRIPTION

The LSH-6335/LSH-6435 switching regulator is a micro-hybrid circuit designed for use in step-down applications requiring accurate output voltages over combined variations of line, load and temperature. This unique product greatly simplifies switching power supply design. The LSH-6335/LSH-6435 microconverter includes a switching regulator, catch diode and compensation network within a TO-220 style package. Just add a choke and two capacitors to obtain an efficient DC-to-DC converter for 5 Volts at 3 Amps. To increase the output voltage, simply add a programming resistor. The current limit and thermal shutdown features of the LSH-6335/LSH-6435 fully protect the device against overstress conditions.

In order to accommodate various mounting and operating temperature requirements, the LSH-6335 and LSH-6435 are available in 4 package options. The LSH-6335 is offered in 3 TO-220 style lead formations: straight

ABSOLUTE MAXIMUM RATINGS

PARAMETER	SYMBOL	MAXIMUM	UNITS
Input Voltage LSH-6335 LSH-6435	V_{IN}	35 40	Volts
Power Dissipation	P_D	Internally Limited	Watts
Thermal Resistance Junction to Case	θ_{JC}	7	$^{\circ}\text{C}/\text{W}$
Operating Junction Temperature Range TO-220 TO-3	T_J	-25 to 125 -55 to 150	$^{\circ}\text{C}$
Storage Temperature Range TO-3 TO-220	T_{STG}	-65 to 150 -25 to 125	$^{\circ}\text{C}$
Lead Temperature (Soldering) 10 Sec. for TO-220 60 Sec. for TO-3	T_{LEAD}	260 300	$^{\circ}\text{C}$

DEVICE SELECTION GUIDE

DEVICE	V_{IN} MAX	V_{OUT} MAX	LEADS
LSH-6335P	35	27	Straight in-line
LSH-6335PV	35	27	Vertical staggered
LSH-6335PH	35	27	Horizontal staggered
LSH-6435P	40	31	Straight in-line
LSH-6435PV	40	31	Vertical staggered
LSH-6435PH	40	31	Horizontal staggered
LSH-6435	40	31	TO-3
LSH-6435M	40	31	TO-3 Mil screened

BLOCK DIAGRAM

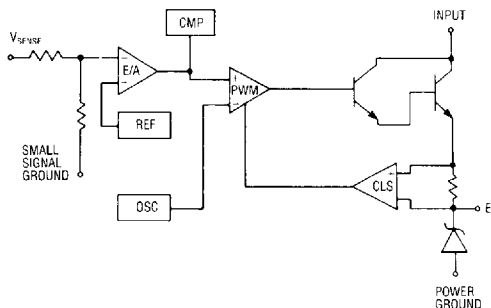

in-line, staggered vertical mount and staggered horizontal mount. A full military temperature range hermetic TO-3 together with inhibit/enable control pin is also available in the LSH-6435.

LSH-6335
LSH-6435

3 AMP DC-TO-DC MICROCONVERTER

ELECTRICAL CHARACTERISTICS

Input test conditions are as follows: $V_{IN} = 24VDC$, $V_O = 5VDC$,
 $I_O = 3A$, $T_J = 25^\circ C$, unless otherwise specified.

11

Parameter	Symbol	Test Conditions			Test Limits			Units
		V_{IN}	I_O	T_J^5	Minimum	Typical	Maximum	
Output Voltage ¹	V_O	12V to $V_{IN(MAX)}$	5mA 0.3A to 3A	Over Temp	4.97 4.80	5.05	5.13 5.30	Volts
Line Regulation ¹	$REG_{(LINE)}$	12V to $V_{IN(MAX)}$				90		mV
Load Regulation ¹	$REG_{(LOAD)}$		0.3A to 3A			45		mV
System Efficiency	η			Over Temp	70	75		%
Switching Frequency	f_{SX}		50mA		60	80	100	kHz
Quiescent Current	I_Q	$V_{IN(MAX)}$	0A			18	30	mA
Peak Current Limit Knee	I_{CL}			Over Temp	3.3			Amps
Short Circuit Current Limit	I_{SC}					7.5		Amps
Output Noise and Ripple ⁴ LSH-6335 LSH-6435	V_N	30V + $5V_{pk-pk}$ 35V + $5V_{pk-pk}$				50		mV_{pk-pk}
Turn On Overshoot			0.3A to 3A			0		mV
Unit Step Load Change			5mA to 3A 3A to 0.05A			0 250		mV mV_{pk}
Programming Resistance ³		12V to $V_{IN(MAX)}$		Over Temp		0.2		Volts/k Ω

(1) Low duty cycle, pulse testing with Kelvin connections required.

(2) 10mS duration.

(3) V_O programming above 5.05V to 27V.

(4) 120 Hz input ripple.

(5) Over temperature – 25°C to 125°C for TO-220; – 55°C to 150°C for TO-3.

MILITARY SCREENING

100% screened in accordance with MIL-STD-883, Method 5004 Class B

Screen	MIL-STD-883 Test Method
Internal Visual	2010
Temperature Cycling	1010
Constant Acceleration	2010
Hermeticity	1014
Electricals	Per Specification
Burn-In	1015
External Visual	2009

3 AMP DC-TO-DC MICROCONVERTER

LSH-6335
LSH-6435

OPERATIONAL DATA

POWER DERATING

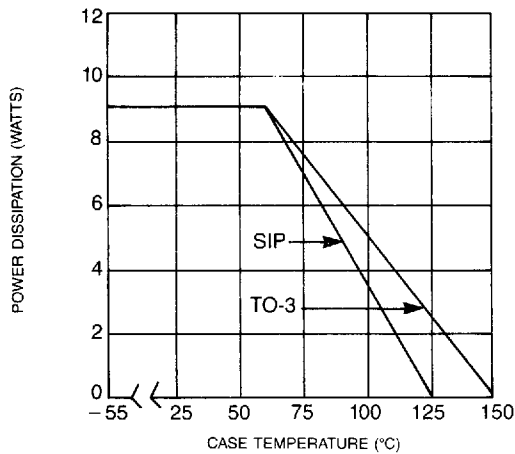

POWER DISSIPATION VS INPUT VOLTAGE

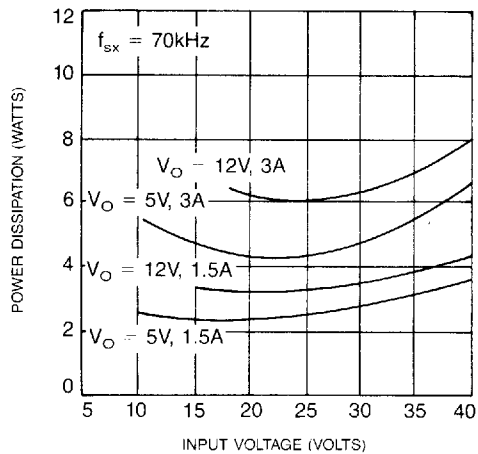

CURRENT LIMIT VS. PERCENT V_{OUT}

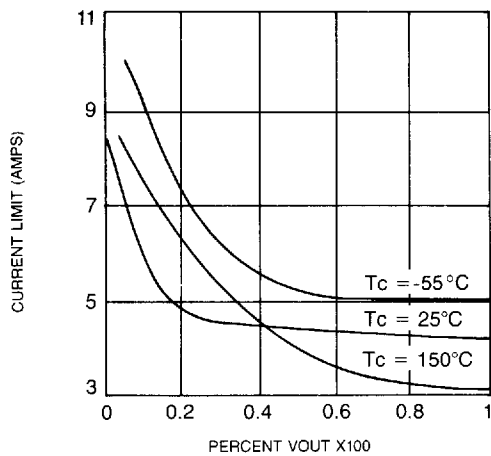

EFFICIENCY VS OUTPUT VOLTAGE

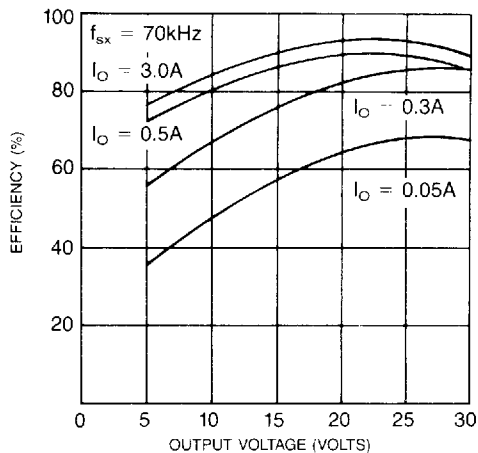

EFFICIENCY VS INPUT VOLTAGE

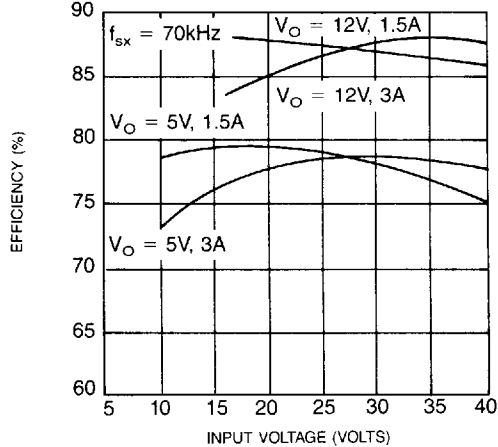

TYPICAL APPLICATION

DC-TO-DC STEP-DOWN CONVERTER^{1,2}

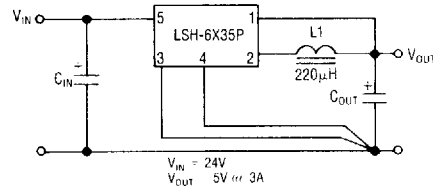

¹ $C_{IN} = 330\mu\text{F}$; $C_{OUT} = 1000\mu\text{F}$

² For output voltages above 5V, add programming resistor between Pin 1 and V_{OUT} .

11

LSH-6335
LSH-6435

3 AMP DC-TO-DC MICROCONVERTER

DEVICE OUTLINE

11

LSH-6X35P
(Front View)

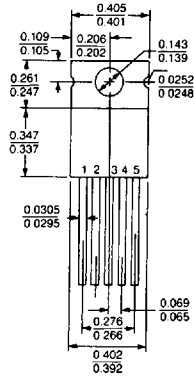

(Side View)

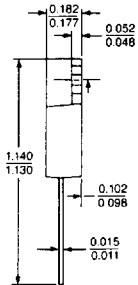

LSH-6X35PV
(Front View)

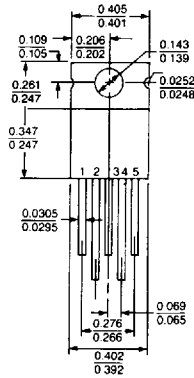

(Side View)

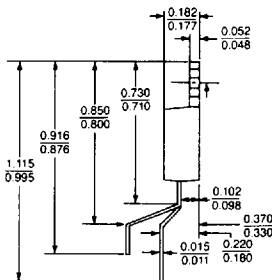

LSH-6X35PH
(Front View)

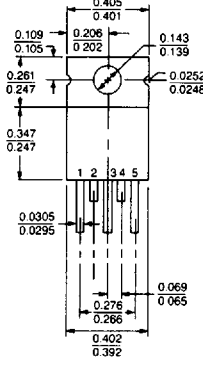

(Side View)

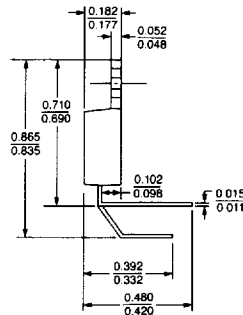

LSH-6435

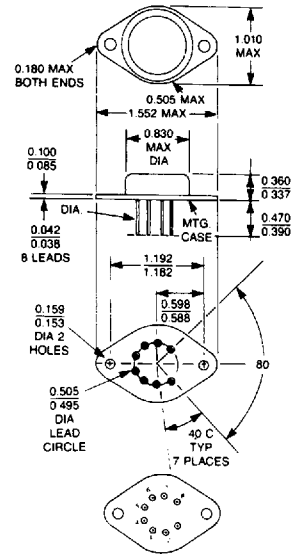

- 1 - V_{SENSE}
- 2 - E_O
- 3 - Small Signal Ground
- 4 - Power Ground
- 5 - Input
- Tab is Small Signal Ground

- 1 - CT
- 2 - Small Signal Ground
- 3 - CNT
- 4 - N/C
- 5 - V_{SENSE}
- 6 - E_O
- 7 - Power Ground
- 8 - Input
- Case is Small Signal Ground

NOTE: All dimensions are in inches.