

Features

- 3V and 5V Input compatible
- Clocking speeds up to 10 MHz
- Reduced clock skew
- 20 ns Switching/delay time
- 2A Peak drive
- Low quiescent current
- Wide operating voltage—
4.5V–16V

Applications

- CCD Drivers requiring high-contrast imaging
- Differential line drivers
- Push-pull circuits

Ordering Information

Part No.	Temp. Range	Pkg.	Outline #
EL7182CN	-40°C to +85°C	8-Pin P-DIP	MDP0031
EL7182CS	-40°C to +85°C	8-Pin SO	MDP0027

General Description

The EL7182C is extremely well suited for driving CCD's, especially where high contrast imaging is desirable. The 16V supply rating is attractive for higher voltage CCD applications, as in color fax machines. The input is TTL and 3V compatible. The low quiescent current requirement is advantageous in portable/battery powered systems. The EL7182 is available in 8-pin P-DIP and 8-lead SO packages.

Connection Diagram

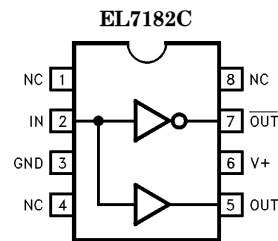

7182-1

Manufactured under U.S. Patent Nos. 5,334,883, # 5,341,047

Note: All information contained in this data sheet has been carefully checked and is believed to be accurate as of the date of publication; however, this data sheet cannot be a "controlled document". Current revisions, if any, to these specifications are maintained at the factory and are available upon your request. We recommend checking the revision level before finalization of your design documentation.

© 1994 Elantec, Inc.

EL7182C

2-Phase, High Speed CCD Driver

Absolute Maximum Ratings

Supply (V+ to Gnd)	16.5V	Operating Junction Temperature	125°C
Input Pins	-0.3V to +0.3V above V+	Power Dissipation	
Combined Peak Output Current	4A	SOIC	570 mW
Storage Temperature Range	-65°C to +150°C	PDIP	1050 mW
Ambient Operating Temperature	-40°C to +85°C		

Important Note:

All parameters having Min/Max specifications are guaranteed. The Test Level column indicates the specific device testing actually performed during production and Quality inspection. Elantec performs most electrical tests using modern high-speed automatic test equipment, specifically the LTX77 Series system. Unless otherwise noted, all tests are pulsed tests, therefore $T_J = T_C = T_A$.

Test Level	Test Procedure
I	100% production tested and QA sample tested per QA test plan QCX0002.
II	100% production tested at $T_A = 25^\circ\text{C}$ and QA sample tested at $T_A = 25^\circ\text{C}$, T_{MAX} and T_{MIN} per QA test plan QCX0002.
III	QA sample tested per QA test plan QCX0002.
IV	Parameter is guaranteed (but not tested) by Design and Characterization Data.
V	Parameter is typical value at $T_A = 25^\circ\text{C}$ for information purposes only.

DC Electrical Characteristics $T_A = 25^\circ\text{C}$, $V = 15\text{V}$ unless otherwise specified

Parameter	Description	Test Conditions	Min	Typ	Max	Test Level	Units
Input							
V_{IH}	Logic "1" Input Voltage		2.4			I	V
I_{IH}	Logic "1" Input Current	@V+		0.1	10	I	μA
V_{IL}	Logic "0" Input Voltage				0.8	I	V
I_{IL}	Logic "0" Input Current	@0V		0.1	10	I	μA
V_{HVS}	Input Hysteresis			0.3		V	V
Output							
R_{OH}	Pull-Up Resistance	$I_{OUT} = -100\text{ mA}$		3	6	I	Ω
R_{OL}	Pull-Down Resistance	$I_{OUT} = +100\text{ mA}$		4	6	I	Ω
I_{PK}	Peak Output Current	Source Sink		2 2		IV	A
I_{DC}	Continuous Output Current	Source/Sink	100			I	mA
Power Supply							
I_S	Power Supply Current	Input High		2.5	5	I	mA
V_S	Operating Voltage		4.5		16	I	V

EL7182C

2-Phase, High Speed CCD Driver

AC Electrical Characteristics $T_A = 25^\circ\text{C}$, $V = 15\text{V}$ unless otherwise specified

Parameter	Description	Test Conditions	Min	Typ	Max	Test Level	Units
Switching Characteristics							
t_R	Rise Time	$C_L = 500\text{ pF}$ $C_L = 1000\text{ pF}$		7.5 10	20	IV	ns
t_F	Fall Time	$C_L = 500\text{ pF}$ $C_L = 1000\text{ pF}$		10 13	20	IV	ns
t_{D-ON}	Turn-On Delay Time			18	25	IV	ns
t_{D-OFF}	Turn-Off Delay Time			20	25	IV	ns

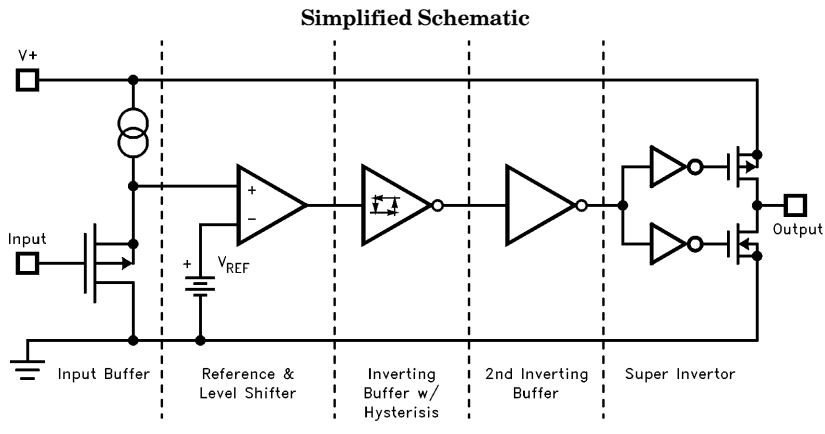
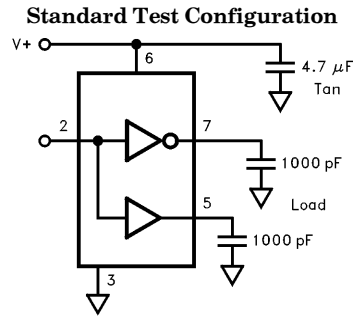
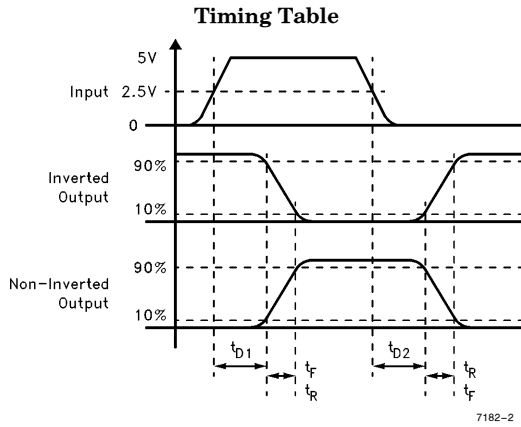

EL7182C

2-Phase, High Speed CCD Driver

Typical Performance Curve

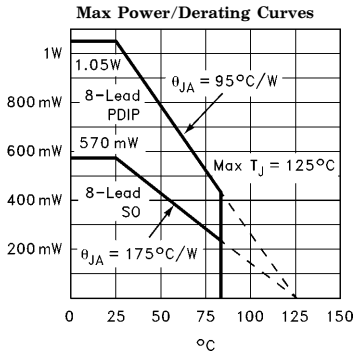

7182-15

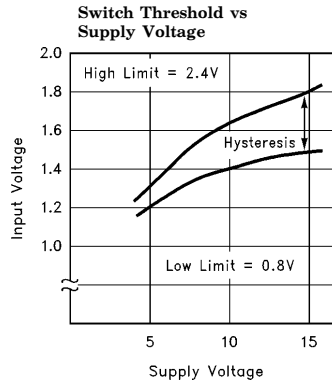

7182-4

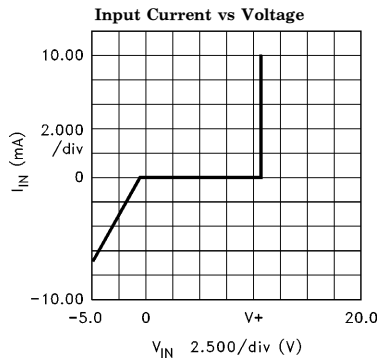

7182-5

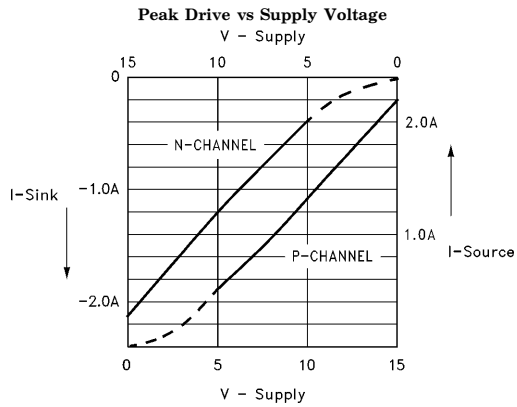

7182-6

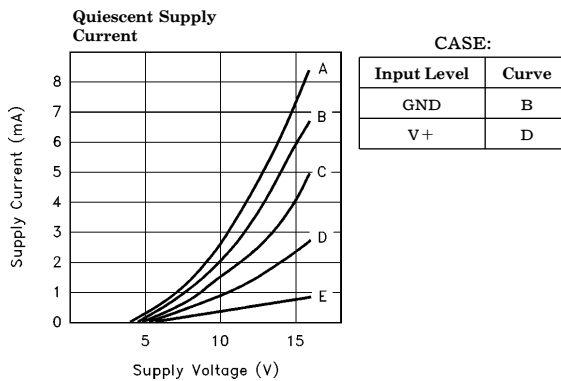

7182-7

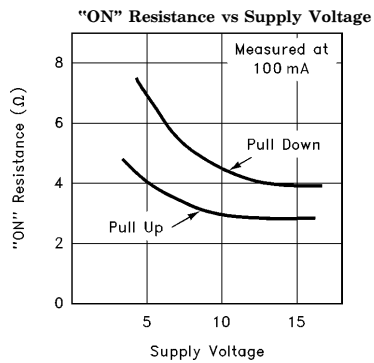

7182-16

EL7182C

2-Phase, High Speed CCD Driver

Typical Performance Curve — Contd.

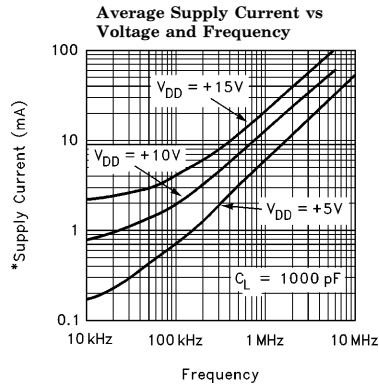

7182-8

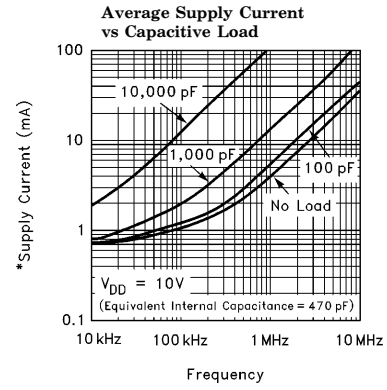

7182-9

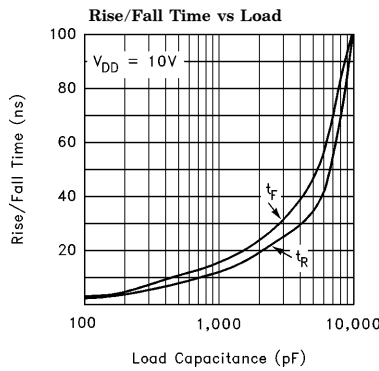

7182-14

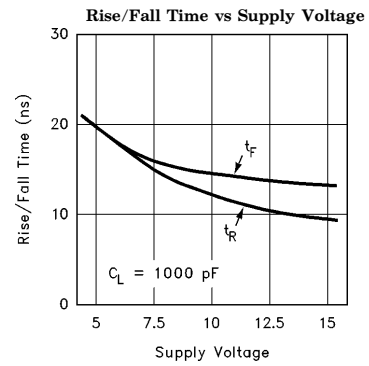

7182-10

EL7182C

2-Phase, High Speed CCD Driver

Typical Performance Curve — Contd.

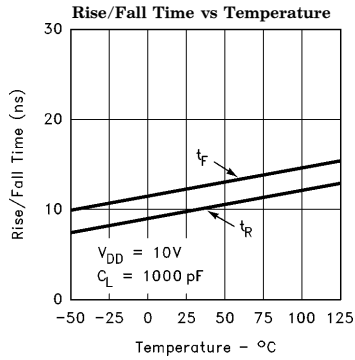

7182-12

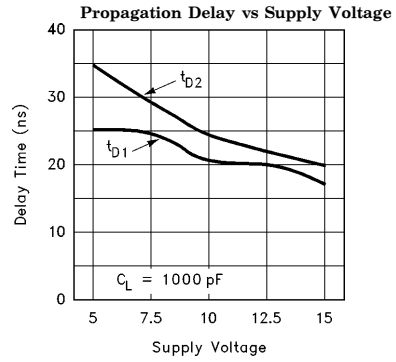

7182-11

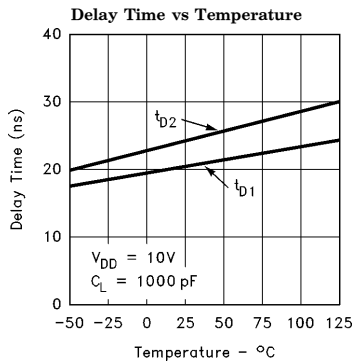

7182-13

BLANK

EL7182C

2-Phase, High Speed CCD Driver

General Disclaimer

Specifications contained in this data sheet are in effect as of the publication date shown. Elantec, Inc. reserves the right to make changes in the circuitry or specifications contained herein at any time without notice. Elantec, Inc. assumes no responsibility for the use of any circuits described herein and makes no representations that they are free from patent infringement.

élantec
HIGH PERFORMANCE ANALOG INTEGRATED CIRCUITS

Elantec, Inc.

1996 Tarob Court

Milpitas, CA 95035

Telephone: (408) 945-1323

(800) 333-6314

Fax: (408) 945-9305

European Office: 44-71-482-4596

WARNING — Life Support Policy

Elantec, Inc. products are not authorized for and should not be used within Life Support Systems without the specific written consent of Elantec, Inc. Life Support systems are equipment intended to support or sustain life and whose failure to perform when properly used in accordance with instructions provided can be reasonably expected to result in significant personal injury or death. Users contemplating application of Elantec, Inc. products in Life Support Systems are requested to contact Elantec, Inc. factory headquarters to establish suitable terms & conditions for these applications. Elantec, Inc.'s warranty is limited to replacement of defective components and does not cover injury to persons or property or other consequential damages.