

NPN Silicon AF Transistors

- For general AF applications
- High collector current
- High current gain
- Low collector-emitter saturation voltage
- Complementary types: BC 807W, BC 808W (PNP)

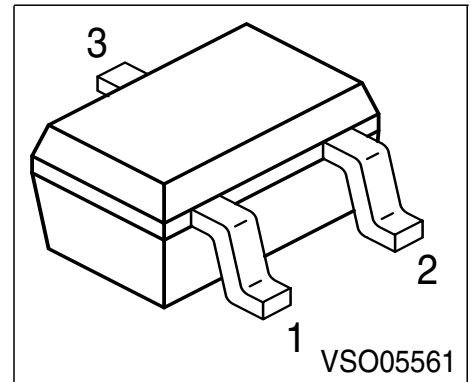

Type	Marking	Pin Configuration			Package
BC 817-16W	6As	1 = B	2 = E	3 = C	SOT-323
BC 817-25W	6Bs	1 = B	2 = E	3 = C	SOT-323
BC 817-40W	6Cs	1 = B	2 = E	3 = C	SOT-323
BC 818-16W	6Es	1 = B	2 = E	3 = C	SOT-323
BC 818-25W	6Fs	1 = B	2 = E	3 = C	SOT-323
BC 818-40W	6Gs	1 = B	2 = E	3 = C	SOT-323

Maximum Ratings

Parameter	Symbol	BC 817W	BC 818W	Unit
Collector-emitter voltage	V_{CEO}	45	25	V
Collector-base voltage	V_{CBO}	50	30	
Emitter-base voltage	V_{EBO}	5	5	
DC collector current	I_C	500		mA
Peak collector current	I_{CM}	1		
Base current	I_B	100		mA
Peak base current	I_{BM}	200		
Total power dissipation, $T_S = 130\text{ °C}$	P_{tot}	250		mW
Junction temperature	T_j	150		
Storage temperature	T_{stg}	-65 ... 150		

Thermal Resistance

Junction ambient ¹⁾	R_{thJA}	≤215	K/W
Junction - soldering point	R_{thJS}	≤80	

1) Package mounted on pcb 40mm x 40mm x 1.5mm / 0.5cm² Cu

Electrical Characteristics at $T_A = 25^\circ\text{C}$, unless otherwise specified.

Parameter	Symbol	Values			Unit
		min.	typ.	max.	
DC Characteristics					
Collector-emitter breakdown voltage $I_C = 10\text{ mA}, I_B = 0$	$V_{(BR)CEO}$				V
BC 817W		45	-	-	
BC 818W		25	-	-	
Collector-base breakdown voltage $I_C = 10\text{ }\mu\text{A}, I_B = 0$	$V_{(BR)CBO}$				
BC 817W		50	-	-	
BC 818W		30	-	-	
Emitter-base breakdown voltage $I_E = 10\text{ }\mu\text{A}, I_C = 0$	$V_{(BR)EBO}$	5	-	-	
Collector cutoff current $V_{CB} = 25\text{ V}, I_E = 0$	I_{CBO}	-	-	100	nA
Collector cutoff current $V_{CB} = 25\text{ V}, I_E = 0, T_A = 150\text{ }^\circ\text{C}$	I_{CBO}	-	-	50	μA
Emitter cutoff current $V_{EB} = 4\text{ V}, I_C = 0$	I_{EBO}	-	-	100	nA
DC current gain 1) $I_C = 100\text{ mA}, V_{CE} = 1\text{ V}$	h_{FE}				-
$h_{FE}\text{-grp. 16}$		100	160	250	
$h_{FE}\text{-grp. 25}$		160	250	400	
$h_{FE}\text{-grp. 40}$		250	350	630	
DC current gain 1) $I_C = 300\text{ mA}, V_{CE} = 1\text{ V}$	h_{FE}				
$h_{FE}\text{-grp. 16}$		60	-	-	
$h_{FE}\text{-grp. 25}$		100	-	-	
$h_{FE}\text{-grp. 40}$		170	-	-	
Collector-emitter saturation voltage1) $I_C = 500\text{ mA}, I_B = 50\text{ mA}$	V_{CEsat}	-	-	0.7	V
Base-emitter saturation voltage 1) $I_C = 500\text{ mA}, I_B = 50\text{ mA}$	V_{BEsat}	-	-	1.2	V

 1) Pulse test: $t \leq 300\text{ }\mu\text{s}$, $D = 2\%$

Electrical Characteristics at $T_A = 25^\circ\text{C}$, unless otherwise specified.

Parameter	Symbol	Values			Unit
		min.	typ.	max.	
AC Characteristics					
Transition frequency $I_C = 50\text{ mA}$, $V_{CE} = 5\text{ V}$, $f = 100\text{ MHz}$	f_T	-	170	-	MHz
Collector-base capacitance $V_{CB} = 10\text{ V}$, $f = 1\text{ MHz}$	C_{cb}	-	6	-	pF
Emitter-base capacitance $V_{EB} = 0.5\text{ V}$, $f = 1\text{ MHz}$	C_{eb}	-	60	-	

Total power dissipation $P_{tot} = f(T_A^*; T_S)$

* Package mounted on epoxy

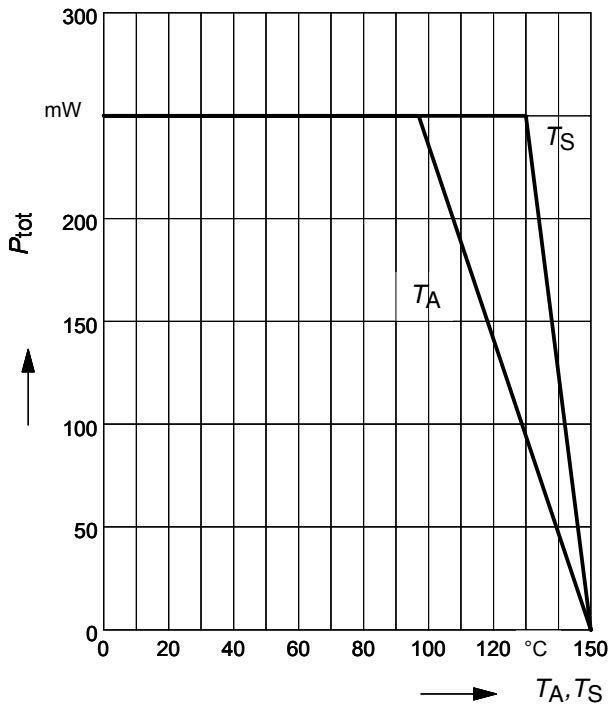

Permissible Pulse Load $R_{thJS} = f(t_p)$

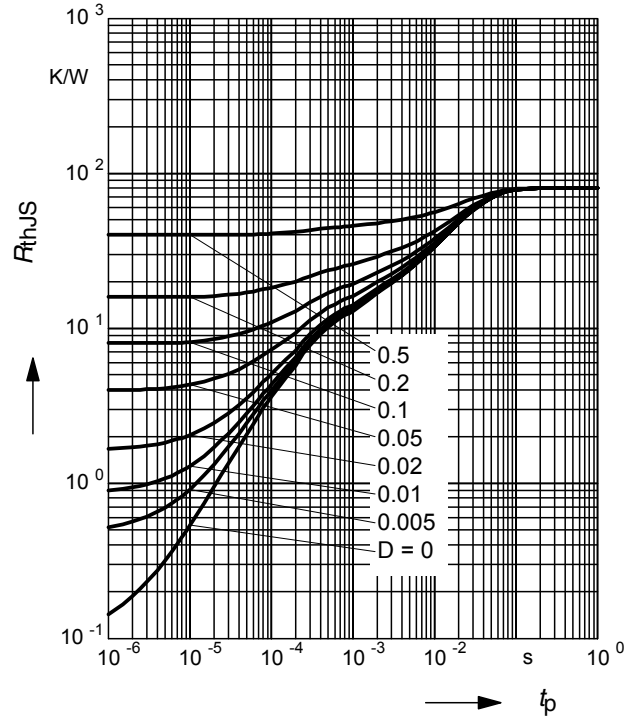

Permissible Pulse Load

$P_{totmax} / P_{totDC} = f(t_p)$

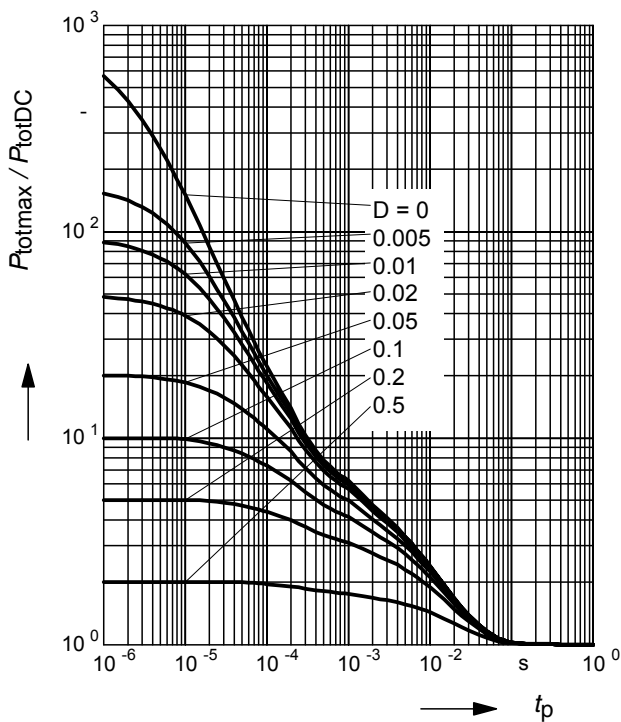

Collector cutoff current $I_{CBO} = f(T_A)$

$V_{CBO} = 25V$

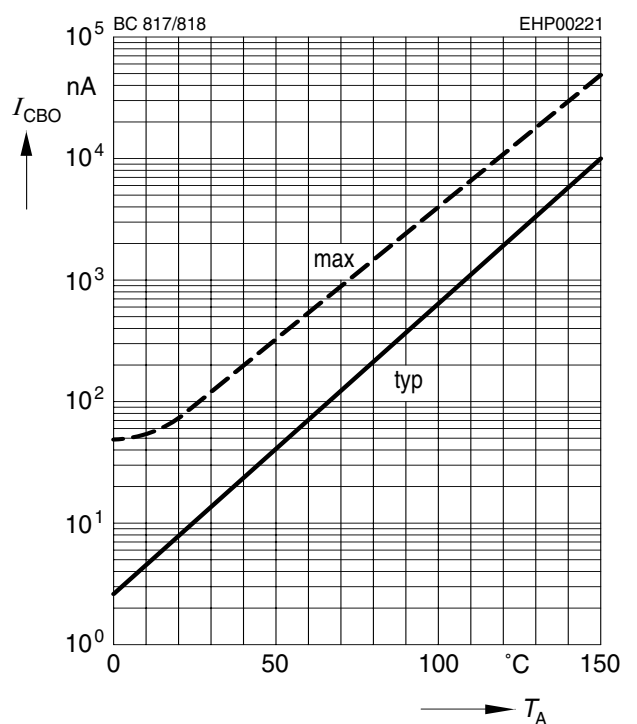

DC current gain $h_{FE} = f(I_C)$

$V_{CE} = 1V$

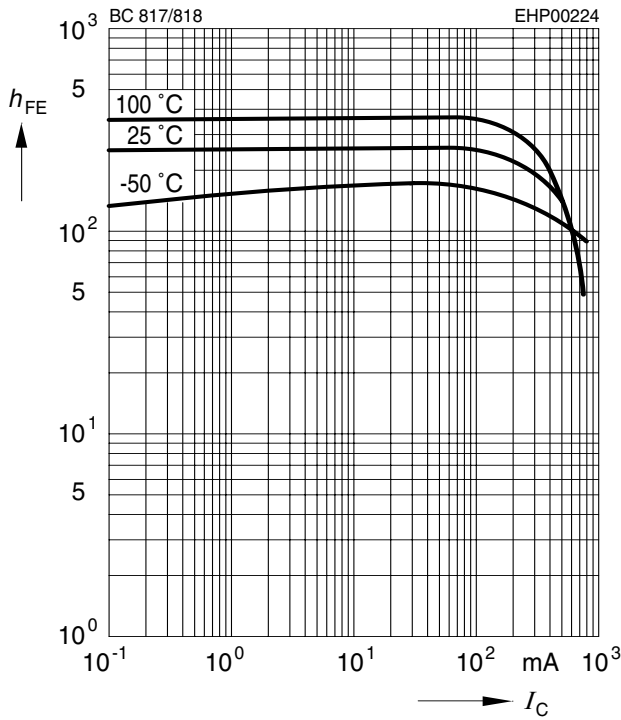

Transition frequency $f_T = f(I_C)$

$V_{CE} = 5V$

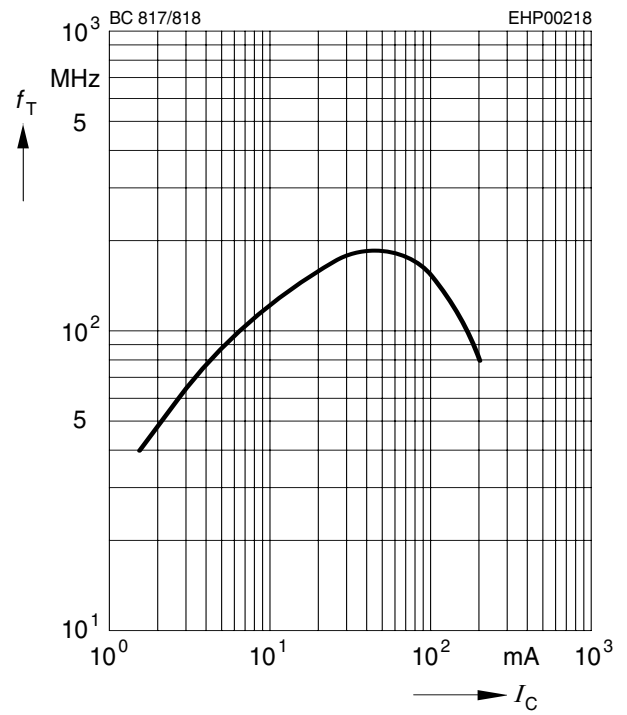

Base-emitter saturation voltage

$I_C = f(V_{BEsat}), h_{FE} = 10$

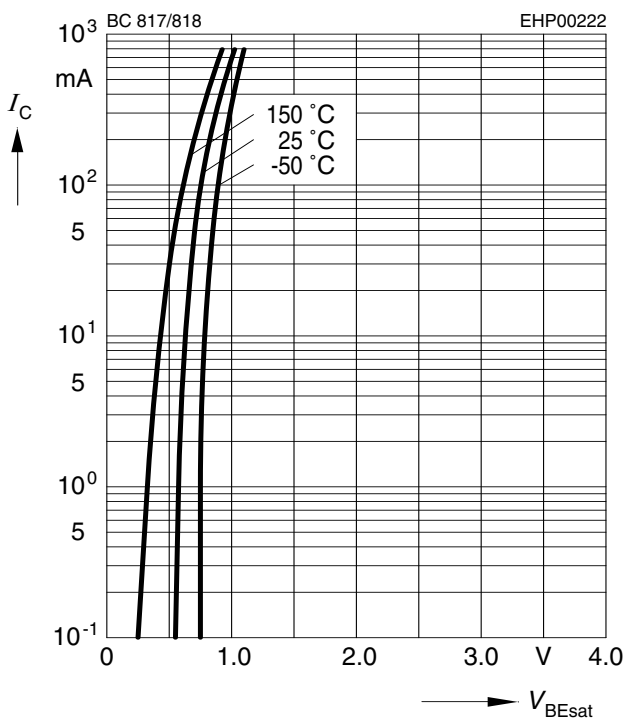

Collector-emitter saturation voltage

$I_C = f(V_{CEsat}), h_{FE} = 10$

