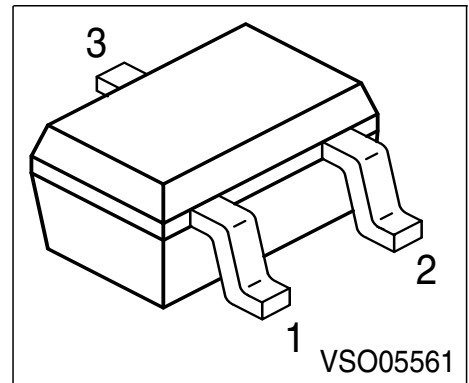
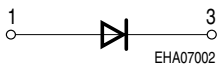
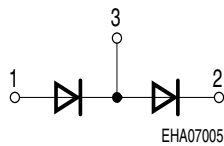
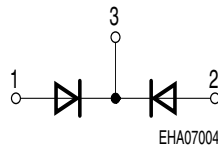
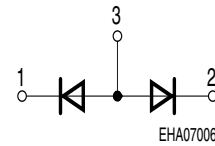

Silicon Schottky Diodes

- For mixer applications in the VHF / UHF range
- For high-speed switching applications

BAT 17W

BAT 17-04W

BAT 17-05W

BAT 17-06W

Type	Marking	Pin Configuration			Package
BAT 17-04W	54s	1 = A1	2 = C2	3 = C1/A2	SOT-323
BAT 17-05W	55s	1 = A1	2 = A2	3 = C1/2	SOT-323
BAT 17-06W	56s	3 = C1	2 = C2	3 = A1/2	SOT-323
BAT 17W	53s	1 = A	2 n.c.	3 = C	SOT-323

Maximum Ratings

Parameter	Symbol	Value	Unit
Diode reverse voltage	V_R	4	V
Forward current	I_F	130	mA
Total power dissipation 1) BAT 17W, $T_A \leq 97^\circ\text{C}$	P_{tot}	150	mW
BAT 17-04W, -05W, -06W, $T_S \leq 92^\circ\text{C}$	P_{tot}	150	
Junction temperature	T_j	150	$^\circ\text{C}$
Operating temperature range	T_{op}	-55 ... 150	
Storage temperature	T_{stg}	-55 ... 150	

Thermal Resistance

Junction - ambient 1) BAT 17W	R_{thJA}	≤ 435	K/W
Junction - ambient 1) BAS 17-04W ...	R_{thJA}	≤ 550	
Junction - soldering point BAT 17W	R_{thJS}	≤ 355	
Junction - soldering point BAT 17-04W ...	R_{thJS}	≤ 390	

1) Package mounted on alumina 15mm x 17.6mm x 0.7mm)

Electrical Characteristics at $T_A = 25\text{ °C}$, unless otherwise specified.

Parameter	Symbol	Values			Unit
		min.	typ.	max.	
DC characteristics					
Breakdown voltage $I_{(BR)} = 10\ \mu\text{A}$	$V_{(BR)}$	4	-	-	V
Reverse current $V_R = 3\ \text{V}$ $V_R = 4\ \text{V}$	I_R	-	-	0.25 10	μA
Reverse current $V_R = 3\ \text{V}, T_A = 60\text{ °C}$	I_R	-	-	1.25	
Forward voltage $I_F = 0.1\ \text{mA}$ $I_F = 1\ \text{mA}$ $I_F = 10\ \text{mA}$	V_F	200 250 350	275 340 425	350 450 600	mV
AC characteristics					
Diode capacitance $V_R = 0\ \text{V}, f = 1\ \text{MHz}$	C_T	0.4	0.55	0.75	pF
Differential forward resistance $I_F = 5\ \text{mA}, f = 100\ \text{kHz}$	r_f	-	8	15	Ω

Forward current $I_F = f(V_F)$

$T_A = \text{parameter}$

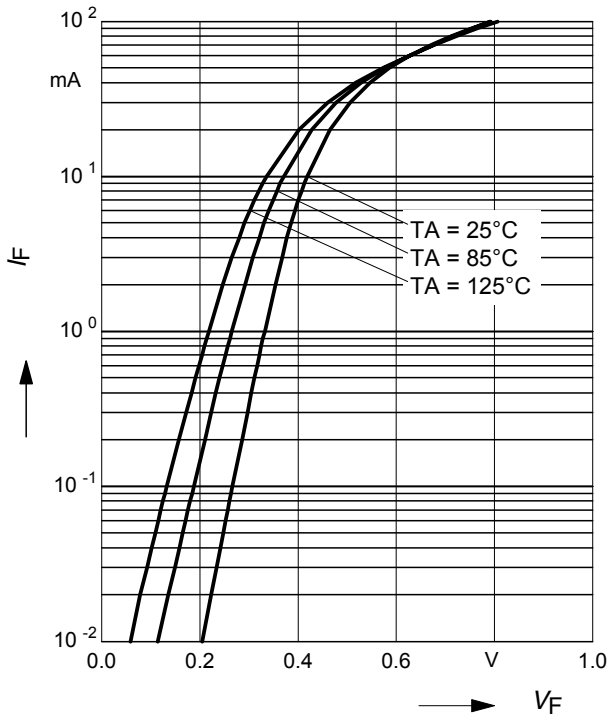

Diode capacitance $C_T = f(V_R)$

$f = 1\text{MHz}$

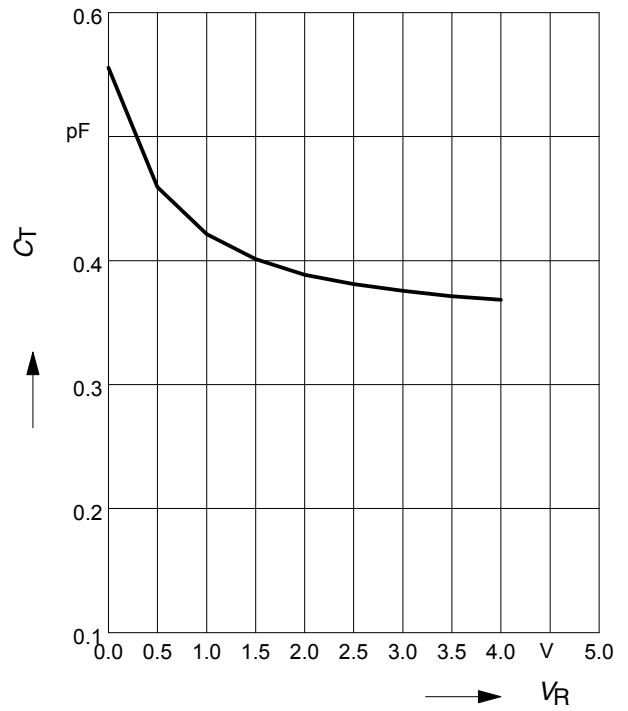

Leakage current $I_R = f(V_R)$

$T_A = \text{Parameter}$

