

# 2SC4299

www.DataSheet4U.com

Silicon NPN Triple Diffused Planar Transistor (High Voltage Switching Transistor)

Application : Switching Regulator and General Purpose

**Absolute maximum ratings** (Ta=25°C)

Symbol	2SC4299	Unit
V <sub>CB0</sub>	900	V
V <sub>CEO</sub>	800	V
V <sub>EBO</sub>	7	V
I <sub>C</sub>	3(Pulse6)	A
I <sub>B</sub>	1.5	A
P <sub>C</sub>	70(Tc=25°C)	W
T <sub>j</sub>	150	°C
T <sub>stg</sub>	-55 to +150	°C

**Electrical Characteristics** (Ta=25°C)

Symbol	Conditions	2SC4299	Unit
I <sub>CB0</sub>	V <sub>CB</sub> =800V	100max	μA
I <sub>EBO</sub>	V <sub>EB</sub> =7V	100max	μA
V <sub>(BR)CEO</sub>	I <sub>C</sub> =10mA	800min	V
h <sub>FE</sub>	V <sub>CE</sub> =4V, I <sub>C</sub> =1A	10to30	
V <sub>CE(sat)</sub>	I <sub>C</sub> =1A, I <sub>B</sub> =0.2A	0.5max	V
V <sub>BE(sat)</sub>	I <sub>C</sub> =1A, I <sub>B</sub> =0.2A	1.2max	V
f <sub>T</sub>	V <sub>CE</sub> =12V, I <sub>E</sub> =-0.3A	6typ	MHZ
COB	V <sub>CB</sub> =10V, f=1MHZ	50typ	pF

**External Dimensions FM100(TO3PF)**

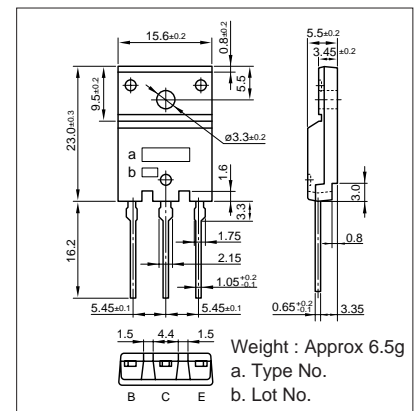

**Typical Switching Characteristics (Common Emitter)**

V <sub>CC</sub> (V)	R <sub>L</sub> (Ω)	I <sub>C</sub> (A)	V <sub>BB1</sub> (V)	V <sub>BB2</sub> (V)	I <sub>B1</sub> (A)	I <sub>B2</sub> (A)	t <sub>on</sub> (μs)	t <sub>stg</sub> (μs)	t <sub>f</sub> (μs)
250	250	1	10	-5	0.15	-0.5	1max	5max	1max

**I<sub>C</sub>-V<sub>CE</sub> Characteristics (Typical)**

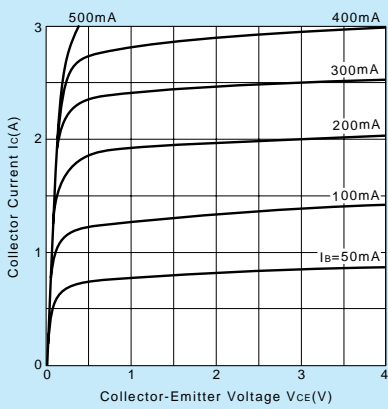

**V<sub>CE(sat)</sub>, V<sub>BE(sat)</sub>-I<sub>C</sub> Temperature Characteristics (Typical)**

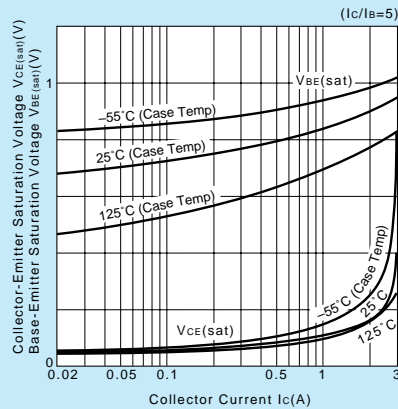

**I<sub>C</sub>-V<sub>BE</sub> Temperature Characteristics (Typical)**

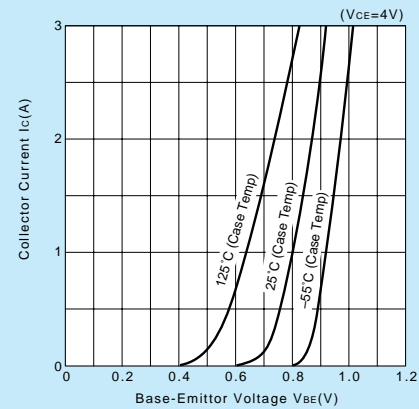

**h<sub>FE</sub>-I<sub>C</sub> Characteristics (Typical)**

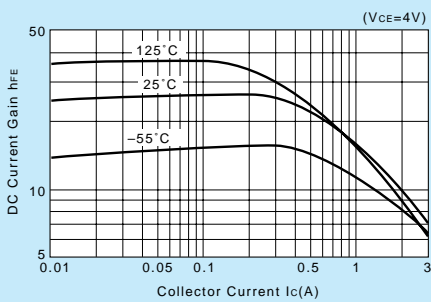

**t<sub>on</sub>\*t<sub>stg</sub>\*t<sub>f</sub>-I<sub>C</sub> Characteristics (Typical)**

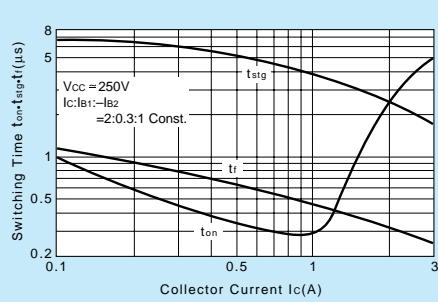

**θ<sub>j-a</sub>-t Characteristics**

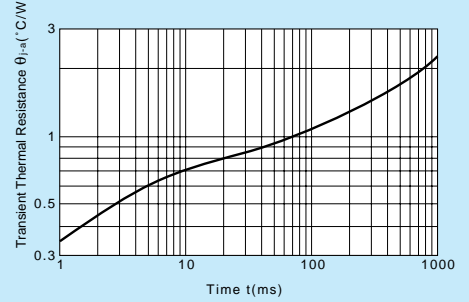

**Safe Operating Area (Single Pulse)**

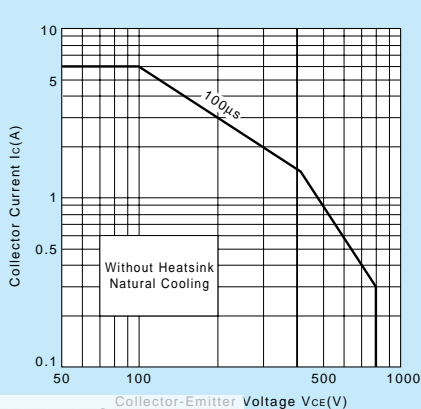

**Reverse Bias Safe Operating Area**

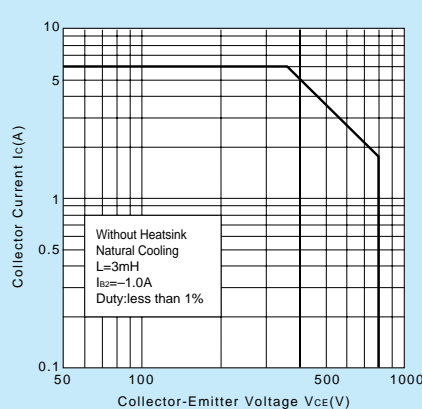

**P<sub>C</sub>-T<sub>a</sub> Derating**

