

4.0-11.0 GHz GaAs MMIC Buffer Amplifier

Features

- ✕ Excellent Transmit LO/Output Buffer Stage
- ✕ Compact Size
- ✕ 23.0 dB Small Signal Gain
- ✕ +20.0 dBm P1dB Compression Point
- ✕ 4.5 dB Noise Figure
- ✕ 100% On-Wafer RF, DC and Output Power Testing
- ✕ 100% Visual Inspection to MIL-STD-883 Method 2010

General Description

Mimix Broadband's two stage 4.0-11.0 GHz GaAs MMIC buffer amplifier has a small signal gain of 23.0 dB with a +20.0 dBm P1dB output compression point. This MMIC uses Mimix Broadband's 0.15 μm GaAs PHEMT device model technology, and is based upon electron beam lithography to ensure high repeatability and uniformity. The chip has surface passivation to protect and provide a rugged part with backside via holes and gold metallization to allow either a conductive epoxy or eutectic solder die attach process. This device is well suited for Microwave and Millimeter-wave Point-to-Point Radio, LMDS, SATCOM and VSAT applications.

Chip Device Layout

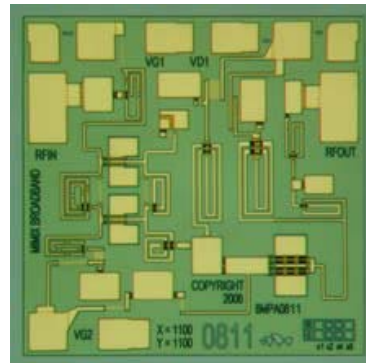

Absolute Maximum Ratings

Supply Voltage (Vd)	+6.0 VDC
Supply Current (Id1)	180 mA
Gate Bias Voltage (Vg)	+0.3 VDC
Input Power (Pin)	+20.0 dBm
Storage Temperature (Tstg)	-65 to +165 °C
Operating Temperature (Ta)	-55 to MTTF Graph ¹
Channel Temperature (Tch)	MTTF Graph ¹

(1) Channel temperature affects a device's MTTF. It is recommended to keep channel temperature as low as possible for maximum life.

Electrical Characteristics (Ambient Temperature T = 25 °C)

Parameter	Units	Min.	Typ.	Max.
Frequency Range (f)	GHz	4.0	-	11.0
Input Return Loss (S11)	dB	-	20.0	-
Output Return Loss (S22)	dB	-	12.0	-
Small Signal Gain (S21)	dB	-	23.0	-
Gain Flatness (ΔS_{21})	dB	-	+/-1.5	-
Reverse Isolation (S12)	dB	-	65.0	-
Noise Figure	dB	-	4.5	-
Output Power for 1dB Compression (P1dB) ²	dBm	-	+20.0	-
Saturated Output Power (Psat)	dBm	-	+21.0	-
Drain Bias Voltage (Vd2)	VDC	-	+4.5	+5.5
Gate Bias Voltage (Vg2)	VDC	-1.0	-0.5	0.0
Supply Current (Id) (Vd=4.5V, Vg2=-0.5V Typical)	mA	-	130	155

(2) Measured using constant current.

4.0-11.0 GHz GaAs MMIC Buffer Amplifier

March 2007 - Rev 06-Mar-07

XB1007-BD

Buffer Amplifier Measurements

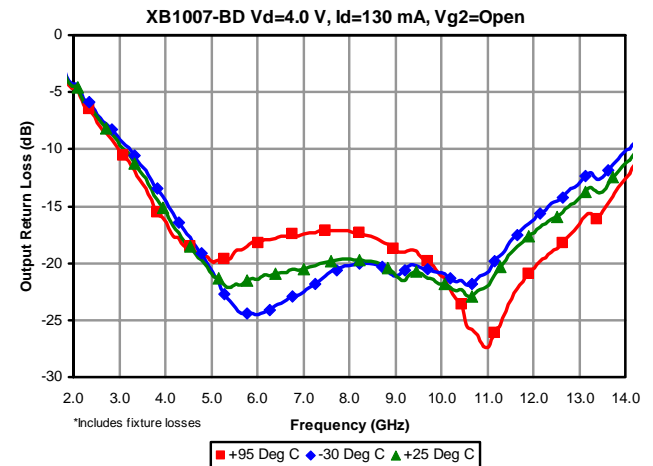
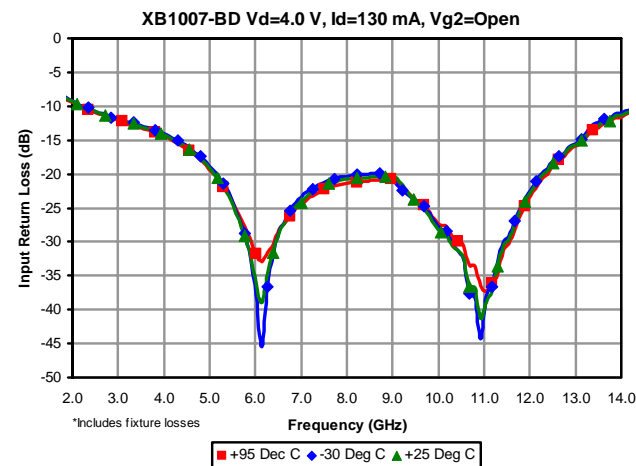
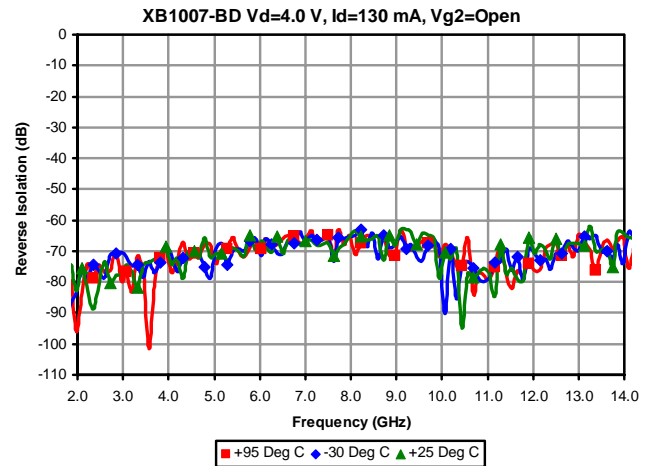
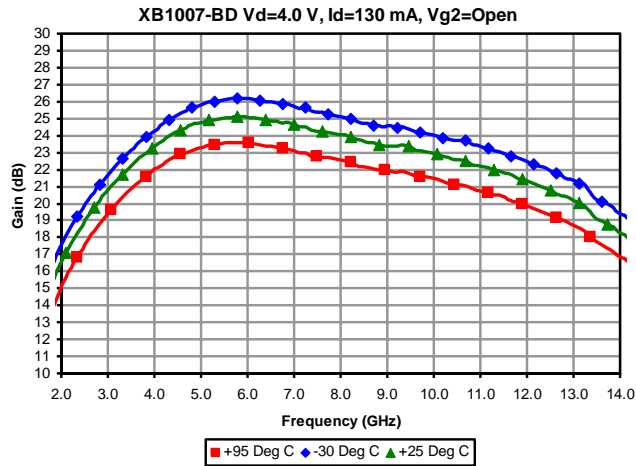

4.0-11.0 GHz GaAs MMIC Buffer Amplifier

March 2007 - Rev 06-Mar-07

Buffer Amplifier Measurements (cont.)

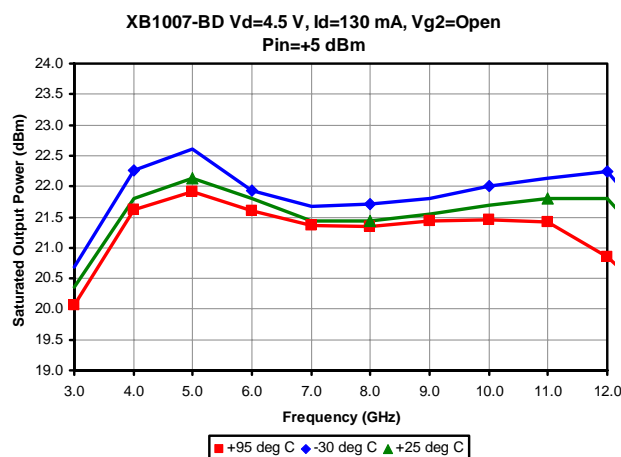
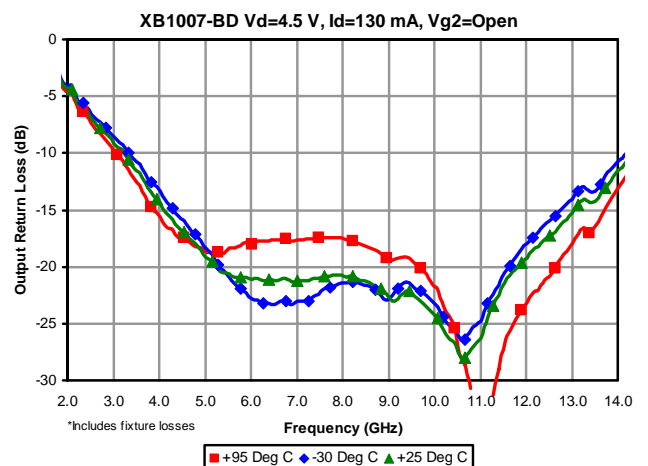
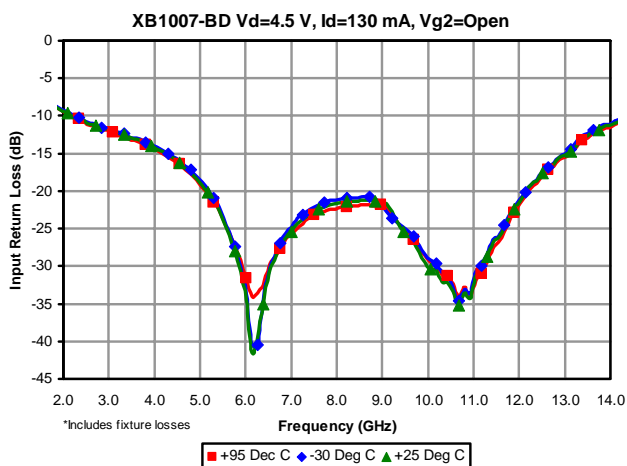
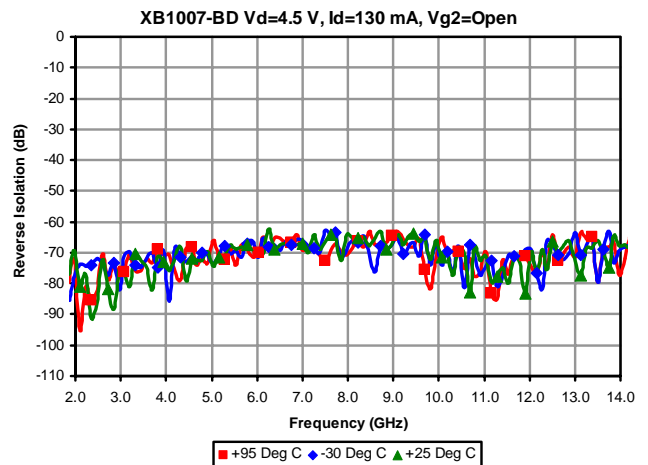
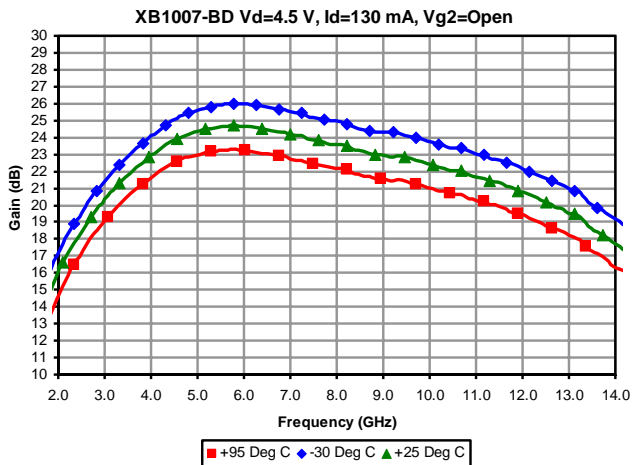

4.0-11.0 GHz GaAs MMIC Buffer Amplifier

March 2007 - Rev 06-Mar-07

X B1007-BD

Buffer Amplifier Measurements (cont.)

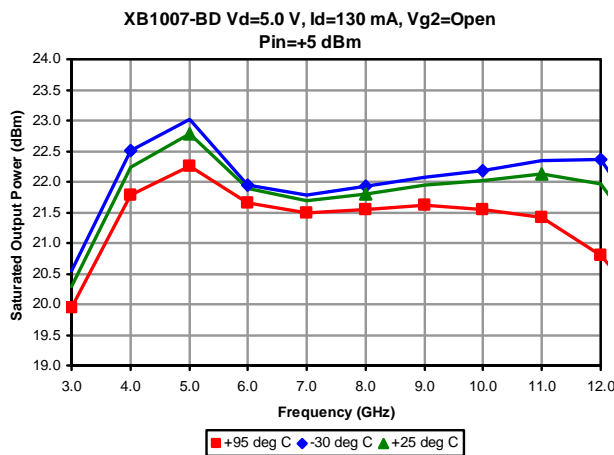
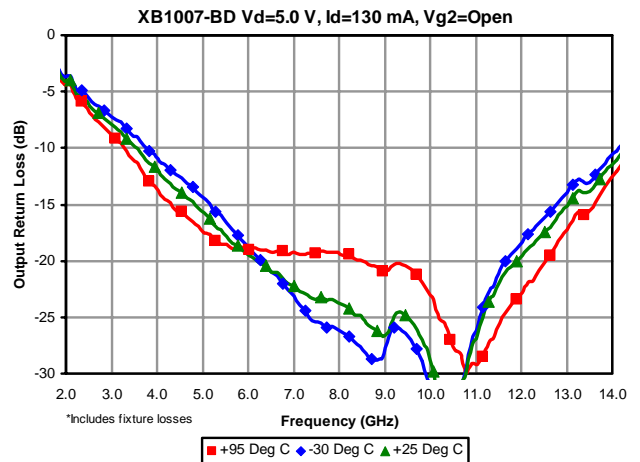
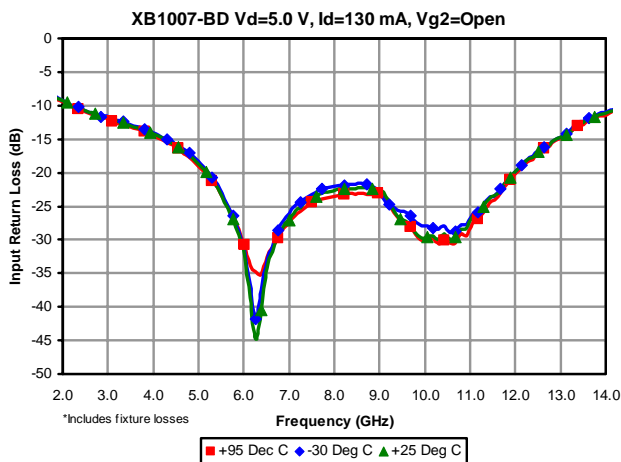
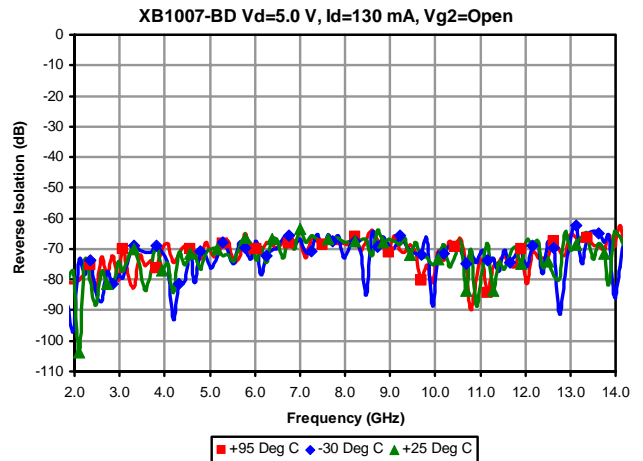
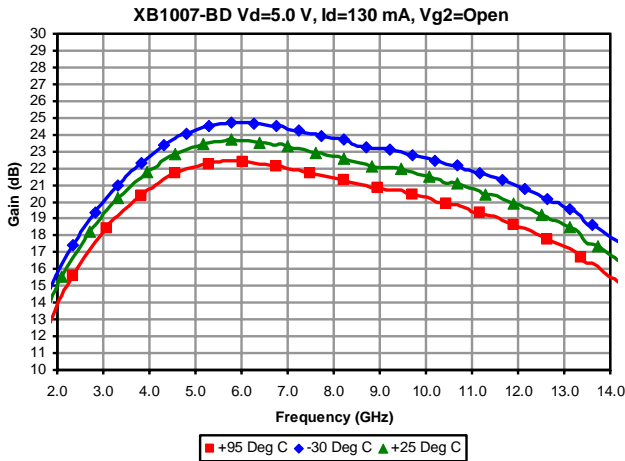

4.0-11.0 GHz GaAs MMIC Buffer Amplifier

March 2007 - Rev 06-Mar-07

X B1007-BD

Buffer Amplifier Measurements (cont.)

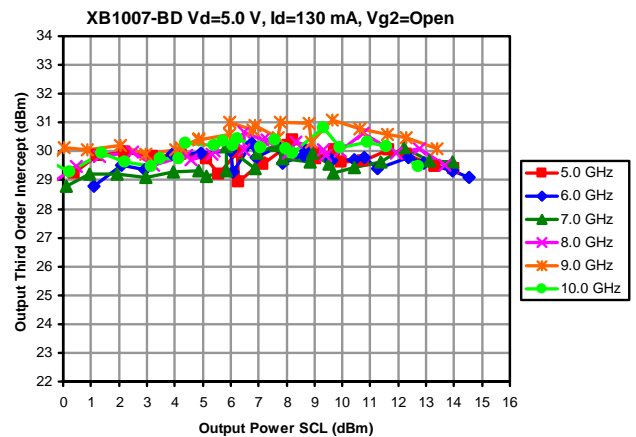
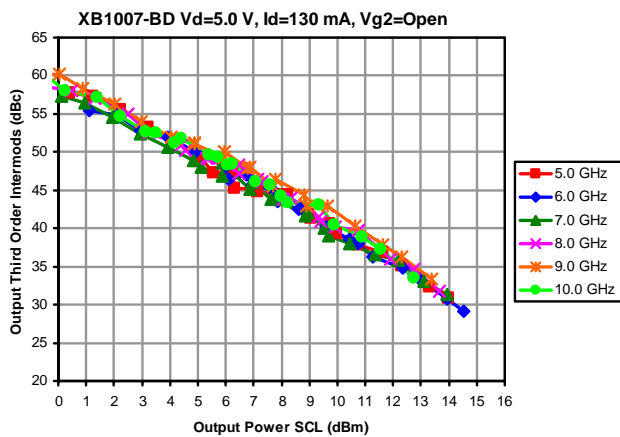
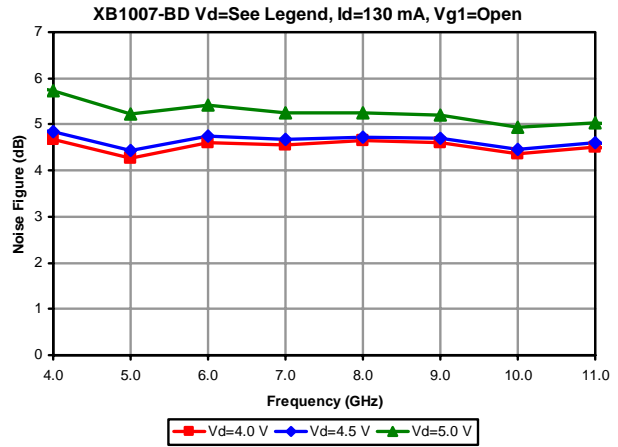
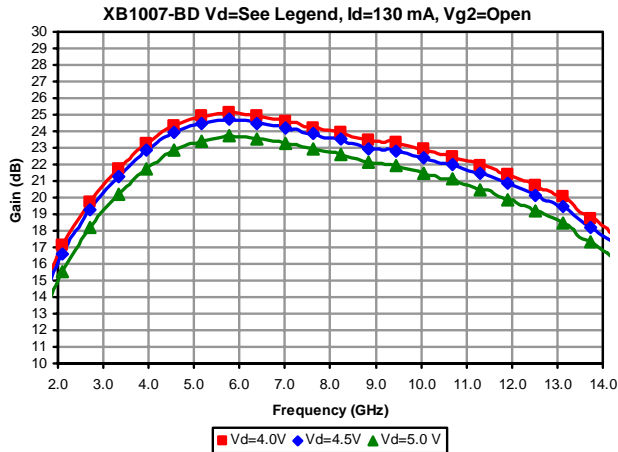

4.0-11.0 GHz GaAs MMIC Buffer Amplifier

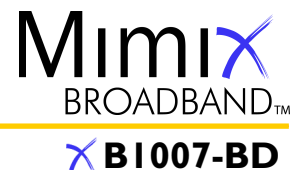

March 2007 - Rev 06-Mar-07

S-Parameters

Typical S-Parameter Data for XB1007-BD
Vd=4.5 V, Id=130 mA

Frequency (GHz)	S11 (Mag)	S11 (Ang)	S21 (Mag)	S21 (Ang)	S12 (Mag)	S12 (Ang)	S22 (Mag)	S22 (Ang)
0.045	0.978	-4.96	0.025	-167.48	0.0012	2.71	1.000	-3.23
1.0	0.558	-47.76	2.108	96.03	0.0001	-117.16	0.881	-75.42
2.0	0.292	-50.93	5.334	55.58	0.0009	141.34	0.646	-133.66
3.0	0.211	-59.68	8.848	17.23	0.0016	81.43	0.502	176.53
4.0	0.189	-81.69	12.975	-20.85	0.0013	32.52	0.392	126.19
5.0	0.148	-92.58	16.002	-61.20	0.0010	14.48	0.299	71.12
6.0	0.049	-131.19	17.813	-103.17	0.0006	-143.50	0.235	2.95
7.0	0.031	103.39	16.657	-140.92	0.0010	90.00	0.183	-58.81
8.0	0.052	40.99	16.006	-173.62	0.0018	76.58	0.177	-98.54
9.0	0.089	14.70	14.867	154.53	0.0027	60.07	0.160	-133.12
10.0	0.044	20.61	14.065	123.27	0.0021	-3.97	0.127	-159.96
11.0	0.014	91.02	12.785	91.14	0.0014	-34.03	0.049	-166.81
12.0	0.058	124.81	11.218	59.48	0.0018	-103.20	0.074	-66.32
13.0	0.141	114.80	9.492	28.22	0.0021	-159.33	0.216	-78.40
14.0	0.223	104.74	7.781	-2.27	0.0037	160.77	0.370	-101.39
15.0	0.279	92.29	6.067	-31.02	0.0041	132.87	0.501	-122.23
16.0	0.329	77.30	4.663	-57.12	0.0038	133.16	0.610	-142.71
17.0	0.361	67.40	3.548	-80.79	0.0030	141.13	0.693	-159.49
18.0	0.376	60.85	2.701	-103.10	0.0058	134.50	0.760	-175.38
19.0	0.373	52.87	2.084	-123.45	0.0082	102.56	0.794	170.52
20.0	0.361	48.90	1.623	-142.31	0.0105	61.49	0.804	159.64

4.0-11.0 GHz GaAs MMIC Buffer Amplifier

March 2007 - Rev 06-Mar-07

Mechanical Drawing

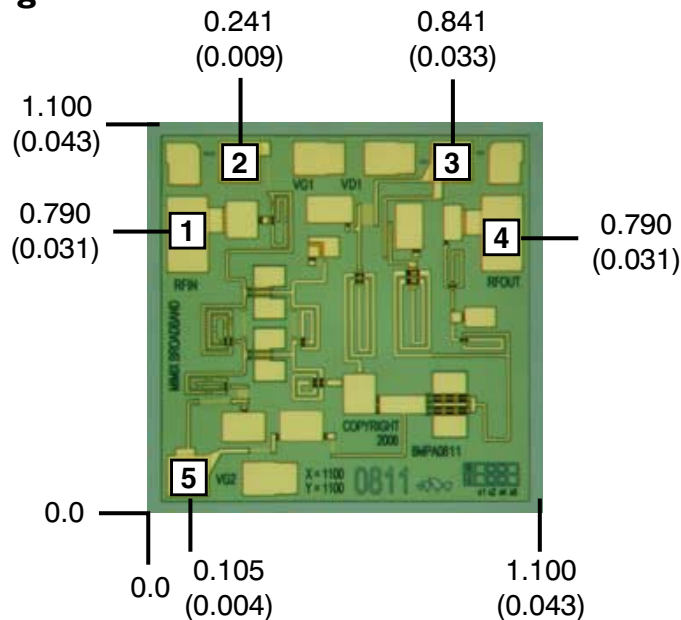

(Note: Engineering designator is 8MPA0811)

Units: millimeters (inches) Bond pad dimensions are shown to center of bond pad.
 Thickness: 0.110 +/- 0.010 (0.0043 +/- 0.0004), Backside is ground, Bond Pad/Backside Metallization: Gold
 All DC Bond Pads (except Vd3) are 0.100 x 0.100 (0.004 x 0.004). All RF Bond Pads (and Vd3) are 0.100 x 0.200 (0.004 x 0.008)
 Bond pad centers are approximately 0.109 (0.004) from the edge of the chip.
 Dicing tolerance: +/- 0.005 (+/- 0.0002). Approximate weight: 0.75 mg.

Bond Pad #1 (RF In)
Bond Pad #2 (Vg1)

Bond Pad #3 (Vd)
Bond Pad #4 (RF Out)

Bond Pad #5 (Vg2)

Bias Arrangement

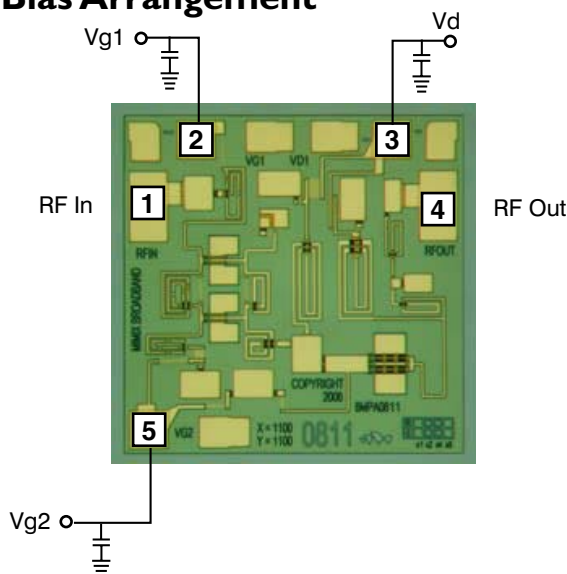

Bypass Capacitors - See App Note [2]

4.0-11.0 GHz GaAs MMIC Buffer Amplifier

March 2007 - Rev 06-Mar-07

App Note [1] Biasing - It is recommended to bias this device at $V_d=4.5V$ with $I_d=130\text{ mA}$ and $V_{g2}=-0.5V$ with V_{g1} left open. It is also recommended to use active biasing to keep the currents constant as the RF power and temperature vary; this gives the most reproducible results. Depending on the supply voltage available and the power dissipation constraints, the bias circuit may be a single transistor or a low power operational amplifier, with a low value resistor in series with the drain supply used to sense the current. The gate of the pHEMT is controlled to maintain correct drain current and thus drain voltage. The typical gate voltage needed to do this is $-0.5V$. Typically the gate is protected with Silicon diodes to limit the applied voltage. Also, make sure to sequence the applied voltage to ensure negative gate bias is available before applying the positive drain supply.

App Note [2] Bias Arrangement - For Individual Stage Bias (Recommended for saturated applications) -- Each DC pad (V_d and $V_{g1,2}$) needs to have DC bypass capacitance ($\sim 100\text{-}200\text{ pF}$) as close to the device as possible. Additional DC bypass capacitance ($\sim 0.01\text{ }\mu\text{F}$) is also recommended.

MTTF Graphs

These numbers were calculated based on accelerated life test information and thermal model analysis received from the fabricating foundry.

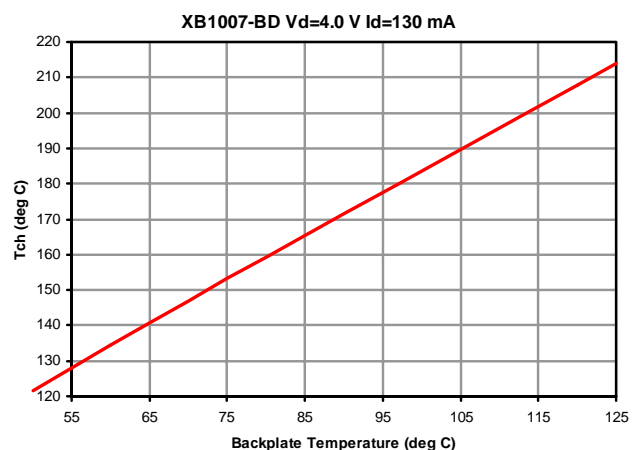
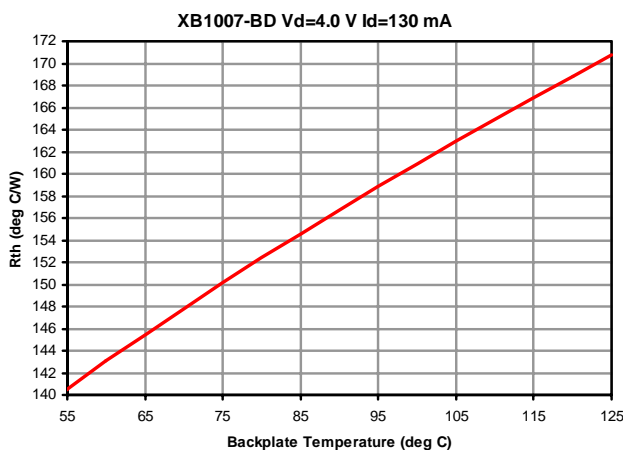
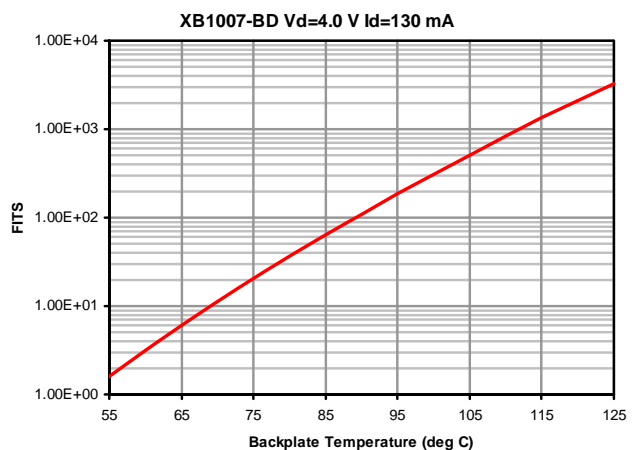
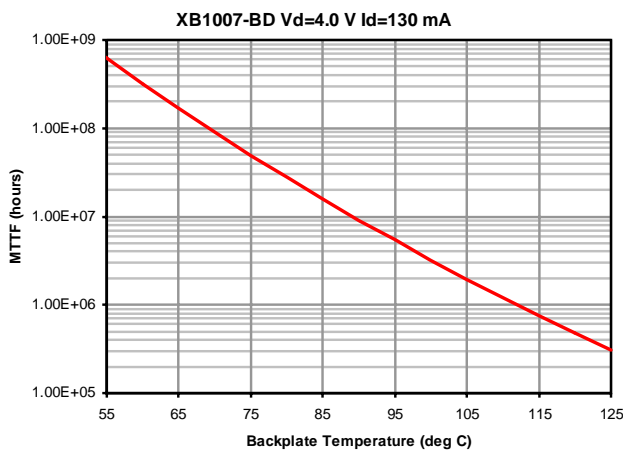

4.0-11.0 GHz GaAs MMIC Buffer Amplifier



March 2007 - Rev 06-Mar-07

Handling and Assembly Information

CAUTION! - Mimix Broadband MMIC Products contain gallium arsenide (GaAs) which can be hazardous to the human body and the environment. For safety, observe the following procedures:

- *Do not ingest.*
- *Do not alter the form of this product into a gas, powder, or liquid through burning, crushing, or chemical processing as these by-products are dangerous to the human body if inhaled, ingested, or swallowed.*
- *Observe government laws and company regulations when discarding this product. This product must be discarded in accordance with methods specified by applicable hazardous waste procedures.*

Life Support Policy - Mimix Broadband's products are not authorized for use as critical components in life support devices or systems without the express written approval of the President and General Counsel of Mimix Broadband. As used herein: (1) Life support devices or systems are devices or systems which, (a) are intended for surgical implant into the body, or (b) support or sustain life, and whose failure to perform when properly used in accordance with instructions for use provided in the labeling, can be reasonably expected to result in a significant injury to the user. (2) A critical component is any component of a life support device or system whose failure to perform can be reasonably expected to cause the failure of the life support device or system, or to affect its safety or effectiveness.

ESD - Gallium Arsenide (GaAs) devices are susceptible to electrostatic and mechanical damage. Die are supplied in antistatic containers, which should be opened in cleanroom conditions at an appropriately grounded anti-static workstation. Devices need careful handling using correctly designed collets, vacuum pickups or, with care, sharp tweezers.

Die Attachment - GaAs Products from Mimix Broadband are 0.100 mm (0.004") thick and have vias through to the backside to enable grounding to the circuit. Microstrip substrates should be brought as close to the die as possible. The mounting surface should be clean and flat. If using conductive epoxy, recommended epoxies are Tanaka TS3332LD, Die Mat DM6030HK or DM6030HK-Pt cured in a nitrogen atmosphere per manufacturer's cure schedule. Apply epoxy sparingly to avoid getting any on to the top surface of the die. An epoxy fillet should be visible around the total die periphery. For additional information please see the Mimix "Epoxy Specifications for Bare Die" application note. If eutectic mounting is preferred, then a fluxless gold-tin (AuSn) preform, approximately 0.001 thick, placed between the die and the attachment surface should be used. A die bonder that utilizes a heated collet and provides scrubbing action to ensure total wetting to prevent void formation in a nitrogen atmosphere is recommended. The gold-tin eutectic (80% Au 20% Sn) has a melting point of approximately 280 °C (Note: Gold Germanium should be avoided). The work station temperature should be 310 °C +/- 10 °C. Exposure to these extreme temperatures should be kept to minimum. The collet should be heated, and the die pre-heated to avoid excessive thermal shock. Avoidance of air bridges and force impact are critical during placement.

Wire Bonding - Windows in the surface passivation above the bond pads are provided to allow wire bonding to the die's gold bond pads. The recommended wire bonding procedure uses 0.076 mm x 0.013 mm (0.003" x 0.0005") 99.99% pure gold ribbon with 0.5-2% elongation to minimize RF port bond inductance. Gold 0.025 mm (0.001") diameter wedge or ball bonds are acceptable for DC Bias connections. Aluminum wire should be avoided. Thermo-compression bonding is recommended though thermosonic bonding may be used providing the ultrasonic content of the bond is minimized. Bond force, time and ultrasonics are all critical parameters. Bonds should be made from the bond pads on the die to the package or substrate. All bonds should be as short as possible.

Part Number for Ordering	Description
XB1007-BD-000V	Where "V" is RoHS compliant die packed in vacuum release gel paks
XB1007-BD-EV1	XB1007 die evaluation module