

POWER MAGNETICS



Pulse offers a complete range of magnetics for both high-frequency switching and low-frequency laminated power supply applications. The switching power magnetics include power inductors, power transformers, current sense magnetics, gate drive transformers and common mode chokes. The laminated power magnetics include both encapsulated and open-frame transformers, as well as ignition transformers for heating and ventilation. For complete product information, please see the "Power Switching Magnetics" or the "Laminated Transformers" catalogs.

Pulse also designs and manufactures a wide array of custom and semi-custom magnetics. Contact Pulse Power Applications Engineering for more information. This catalog section serves as an overview to the Pulse Power product line.

NOTE: For additional listings of Pulse Power magnetics, see other Power data sheets at this URL: <http://www.pulseeng.com/products/datasheets.aspx>.



OVERVIEW: PULSE POWER MAGNETICS



Power Inductors

Surface Mount (SMT)

- Unshielded Drum Core Inductors (up to 30 A)
- Shielded Drum Core Inductors (up to 14 A)
- Power Bead Inductors (up to 45 A)
- Flat Coil Inductors (up to 35 A)
- Planar and Wirewound Inductors (up to 73 A)
- Toroid Inductors (up to 40 A)

Through Hole (THT)

- Toroid Inductors (up to 48 A)
- Power Cube Inductors (up to 50 A)



High-Frequency Power Transformers

Surface Mount (SMT)

- Planar Transformers (30 W, 75 W, 140 W, 250 W)
- Conventional Wound Transformers (Up to 200 W)
- Custom transformers available upon request

Through Hole (THT)

- Conventional Wound Transformers (Up to 500 W)
- Custom transformers available upon request



Gate Drive Transformers

Surface Mount (SMT)

- Operational and Basic Insulation for DC/DC applications (1500 Vbc/1500 Vrms)

Through Hole (THT)

- Reinforced Insulation for AC/DC applications (3000 Vrms)



Current Sense Magnetics

Surface Mount (SMT)

- Operational Insulation (500 Vrms)
- Five platforms (4 A, 10 A, 15 A, 20 A, 35 A)

Through Hole (THT)

- Reinforced Insulation (3000 Vrms)
- Multiple platforms (up to 30 A)



Common Mode Chokes

Surface Mount (SMT)

- Up to 14 A
- 500VRMS and 1500 Vrms Isolation
- Over 10 package sizes available
- Customer designs available upon request

Through Hole (THT)

- Up to 23 A
- 3000 Vrms Isolation
- Multiple package sizes available.



Laminated Transformers

Encapsulated Transformers

- Up to 50 VA
- THT, Low-Profile and Bracket Mount options

Open-Frame Transformers

- Up to 140 VA
- THT, Low-Profile, and Chasis Mount options

Ignition Transformers

- Up to 23 kV

SURFACE MOUNT & THROUGH HOLE INDUCTOR OVERVIEW

Power Inductor Selection Charts, Surface Mount and Through-Hole

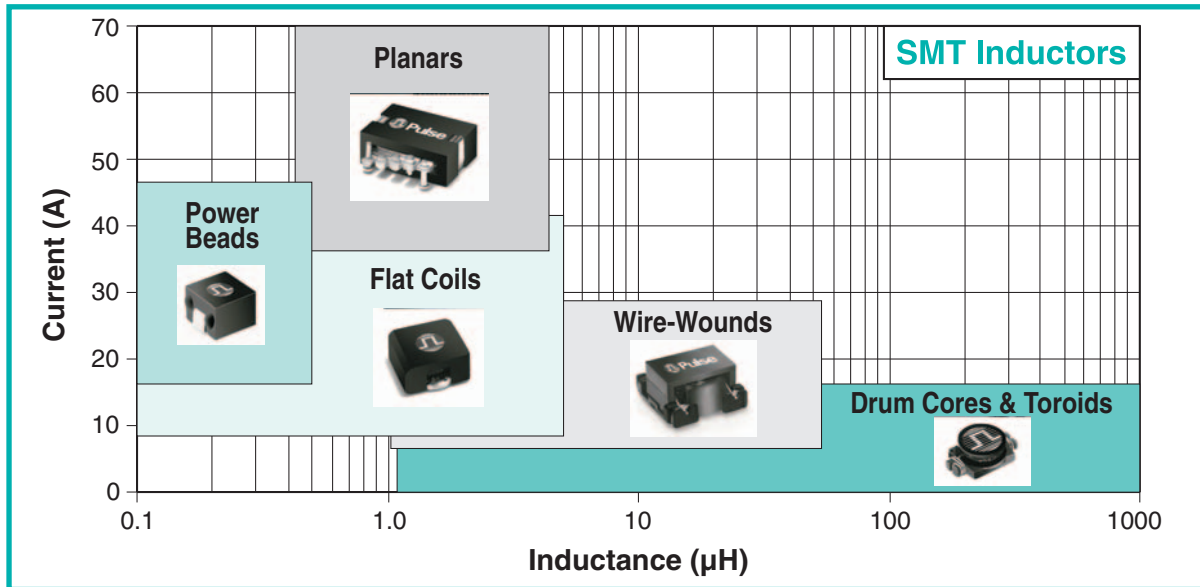

- Power Beads** - low inductance (<0.5 µH) - high current (>25 A) applications
- Flat Coils** - mid-inductance (.5 µH to 4 µH) - medium current (15-30 A) applications
- Planars** - mid-inductance (.5 µH to 4 µH) - high current (>25 A) applications
- Wirewound** - high inductance (>5 µH) - medium current (15-30 A) applications
- Unshielded Drum Core Inductors** - typically for lower current, portable or small power applications
- Shielded Drum Core Inductors** - typically for lower current, portable or small power applications
- Toroid Inductors** - versatile multi-use platforms for single and dual inductors

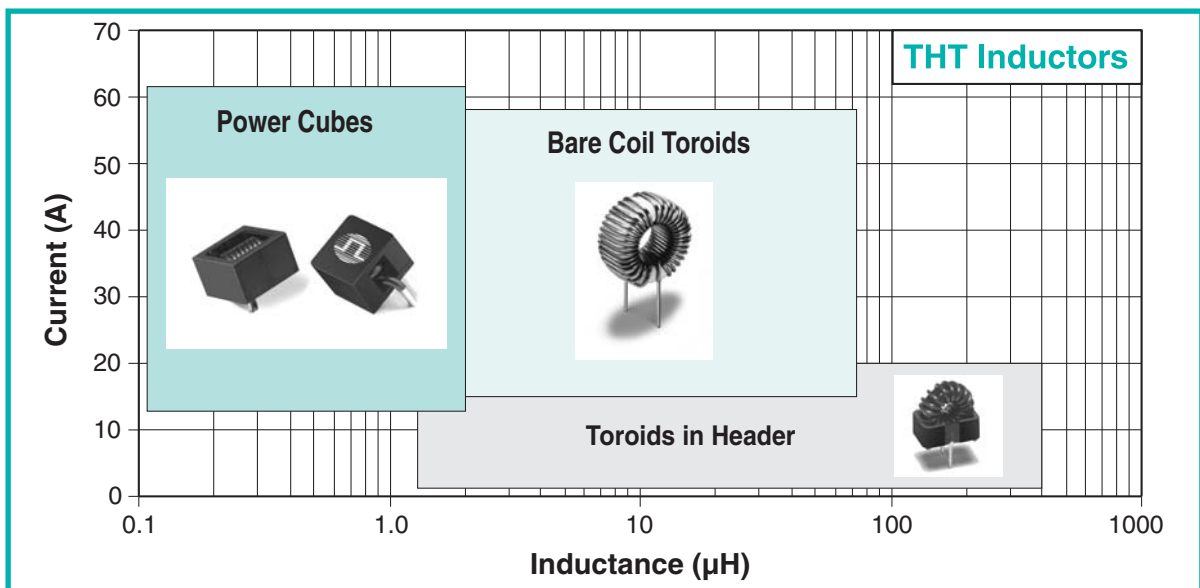

- Power Cube Inductors** - high-current inductors for use in low inductance applications where board space and height are critical
- Bare Coil Toroids** - low cost, general purpose inductors for mid- to high-current applications where over all size is a less critical factor
- Toroid in Header Inductors** - general purpose inductors for low to medium current ranges

POWER MAGNETICS



PRODUCT OVERVIEW: SMT UNSHIELDED DRUM CORE INDUCTORS



- Up to 30 A dc
- Typically for lower current, higher inductance applications
- Lower power DC/DC converters and filter inductors
- Portable and battery powered equipment
- Industry standard footprints

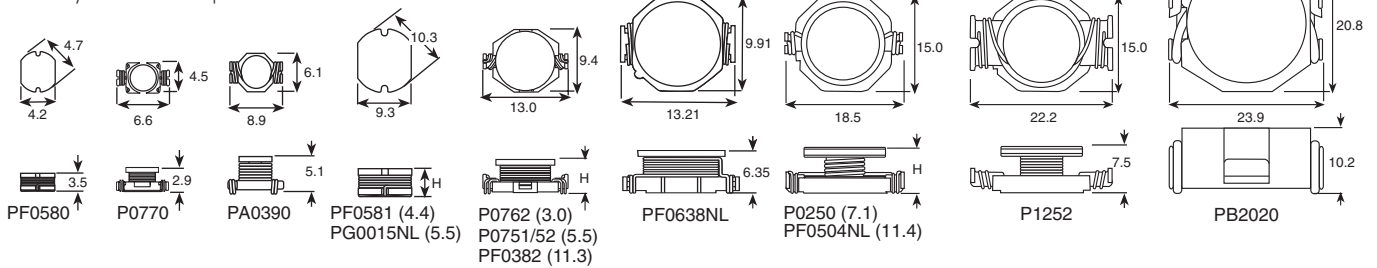
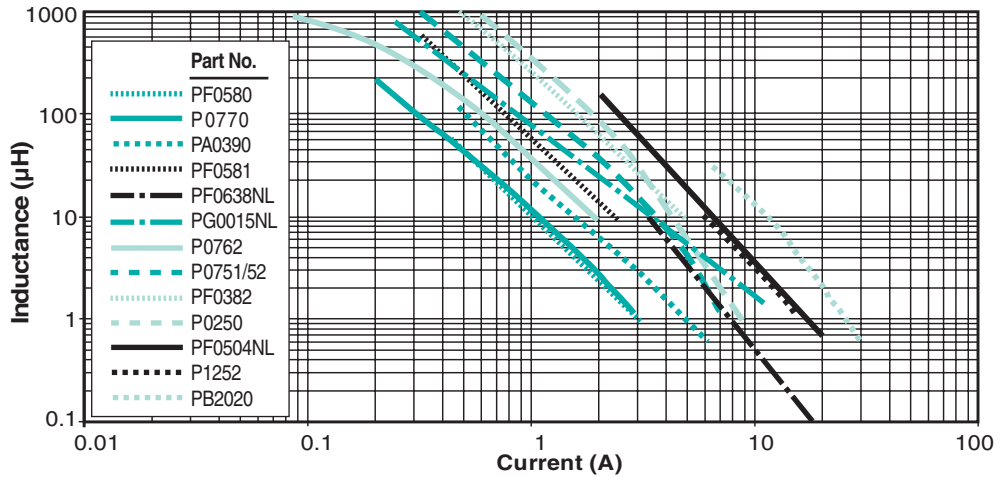

PRODUCT OVERVIEW: SMT SHIELDED DRUM CORE INDUCTORS



- Up to 14 A dc
- Typically for lower current, higher inductance applications requiring low EMI
- Lower power DC/DC converters
- Portable and battery powered equipment
- Industry standard footprints

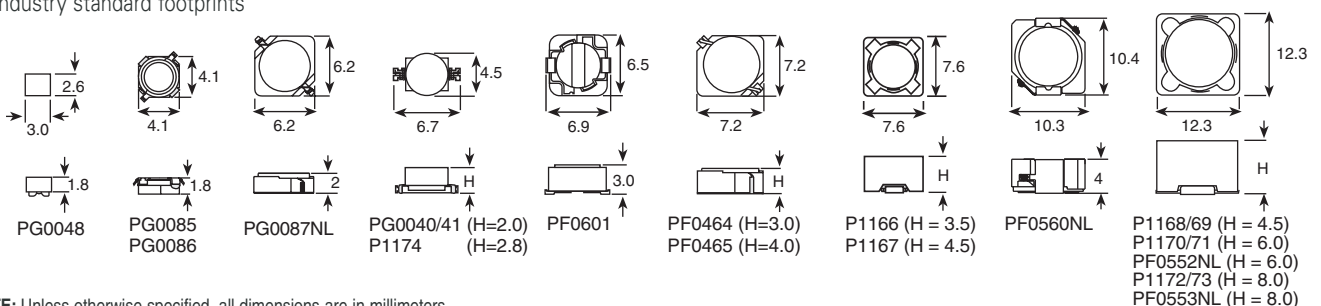
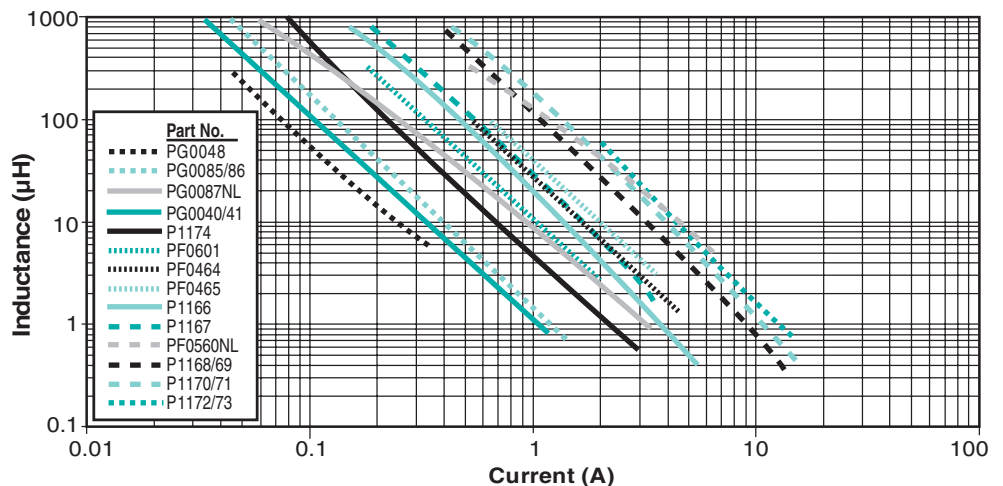

NOTE: Unless otherwise specified, all dimensions are in millimeters.

POWER MAGNETICS



PRODUCT OVERVIEW: POWER BEAD INDUCTORS



- Up to 70 A
- Typically for high current (>30 A) applications requiring inductance values below 0.5 μH
- VRM/VRD and DDR computing applications for server, workstation, portable and desktop
- Integrated and coupled inductors for multi-phase applications

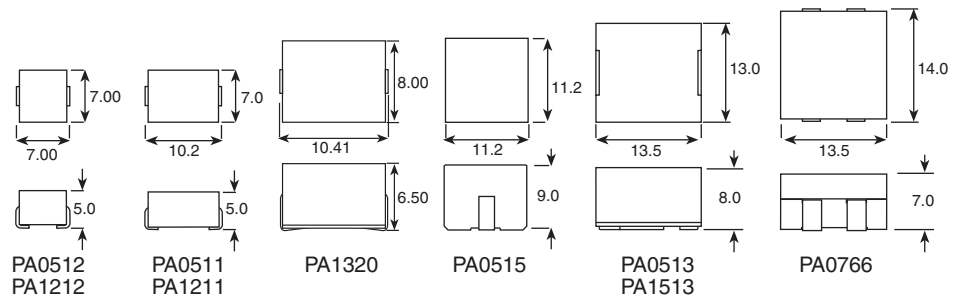
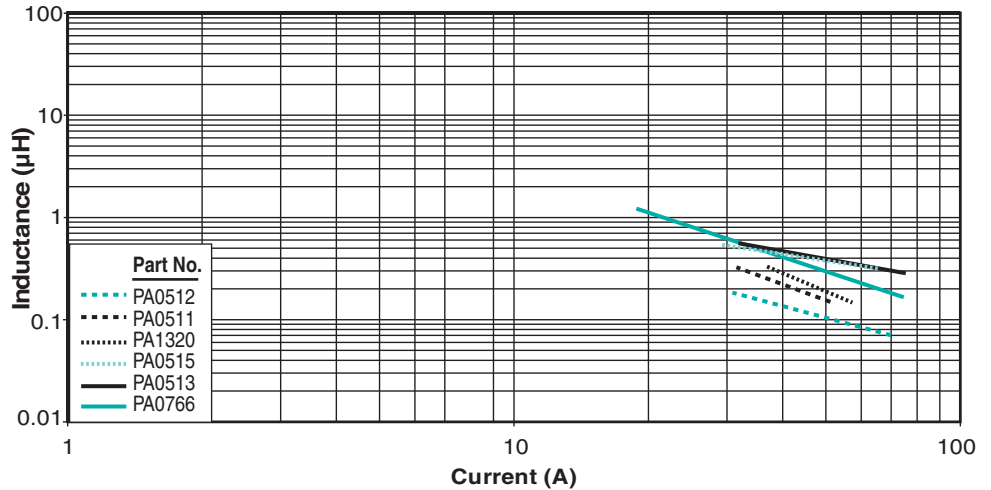

PRODUCT OVERVIEW: FLAT COIL INDUCTORS



- Up to 38 A dc
- Typically for mid- to high-current applications requiring inductance between 0.5 μH and 5.0 μH
- Portable computing, higher power DC/DC converters and Telecom applications
- Industry standard footprints

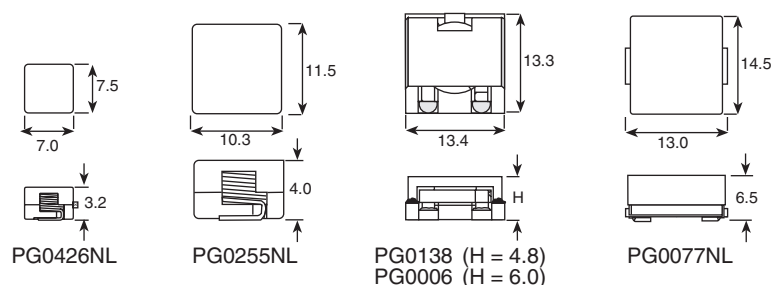
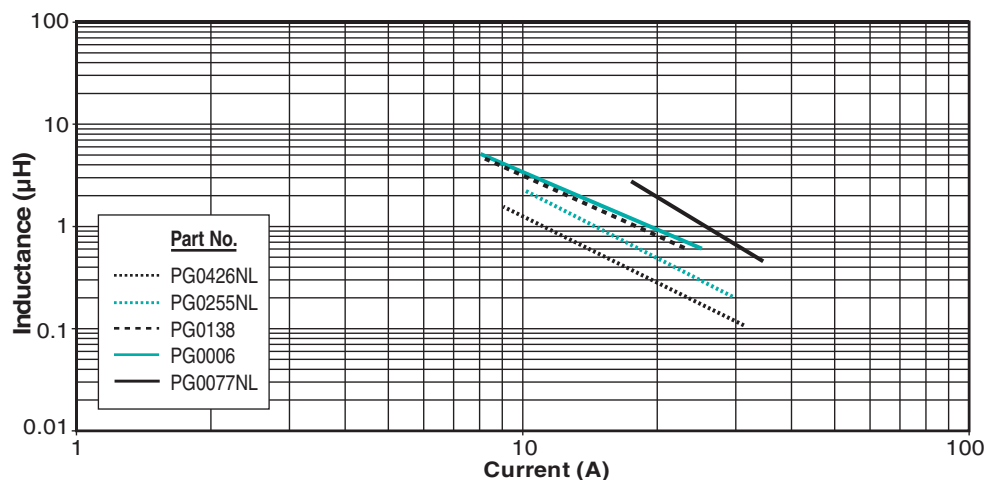

POWER MAGNETICS



PRODUCT OVERVIEW: PLANAR & WIREWOUND INDUCTORS



- Up to 73 A
- Typically for high current (>20 A) applications requiring mid-inductance values (1.0 μ H to 15 μ H)
- Output inductors for isolated DC/DC inductors

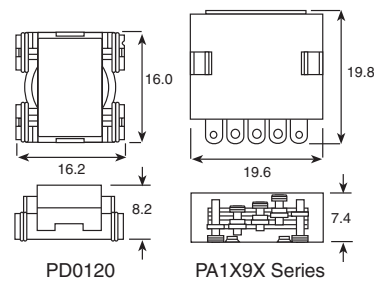
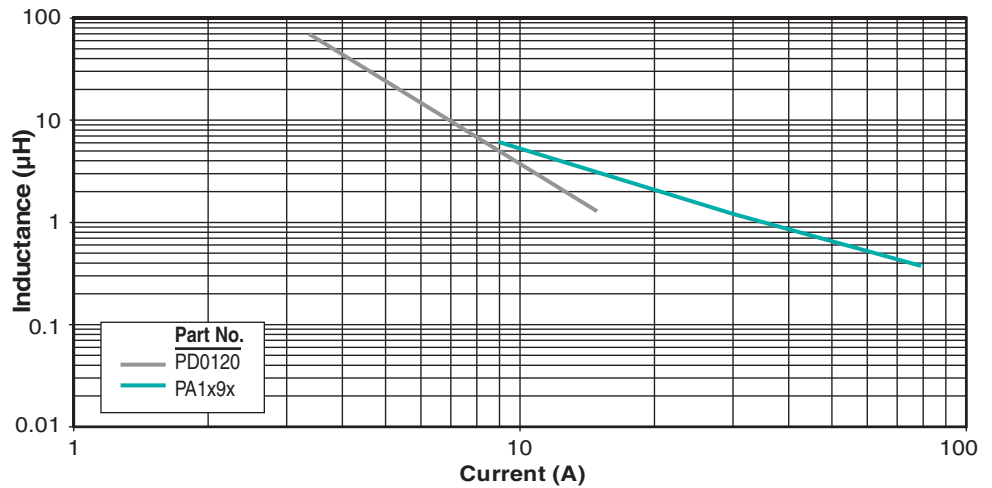

PRODUCT OVERVIEW: SMT TOROID INDUCTORS



- Up to 38 A dc
- Single and dual inductors
- General purpose DC/DC converters and EMI filters
- Versatile and cost-effective

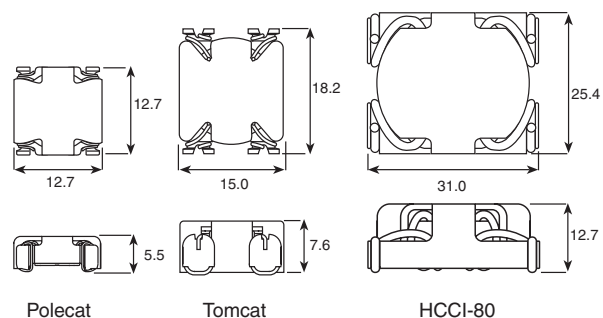
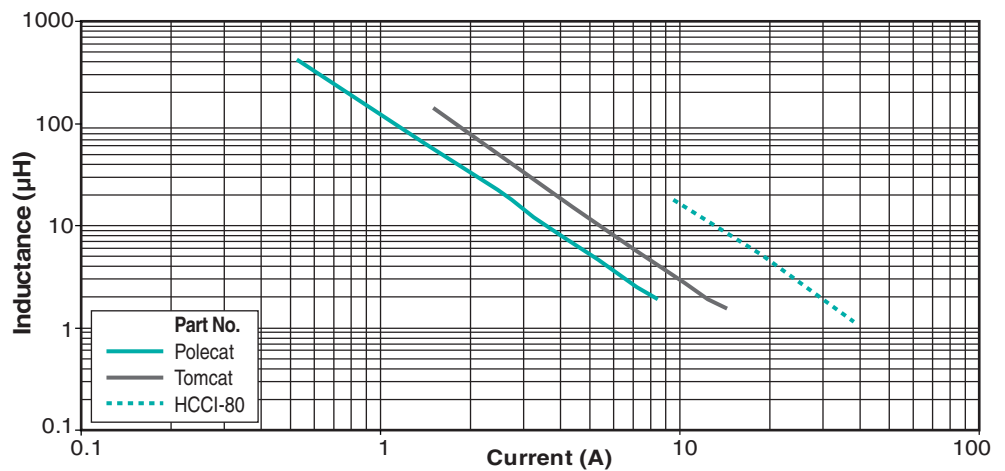

POWER MAGNETICS



PRODUCT OVERVIEW: THT POWER CUBE INDUCTORS

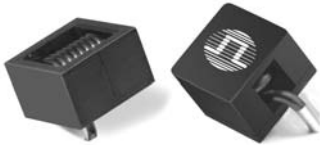

- Up to 45 A_{dc}
- Typically for mid- to high-current applications (10 A to 45 A) requiring lower inductance (0.2 μ H to 3.0 μ H)
- VRD applications for desktops
- Low profile (<10mm)

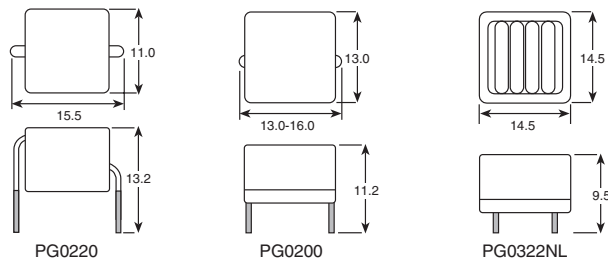
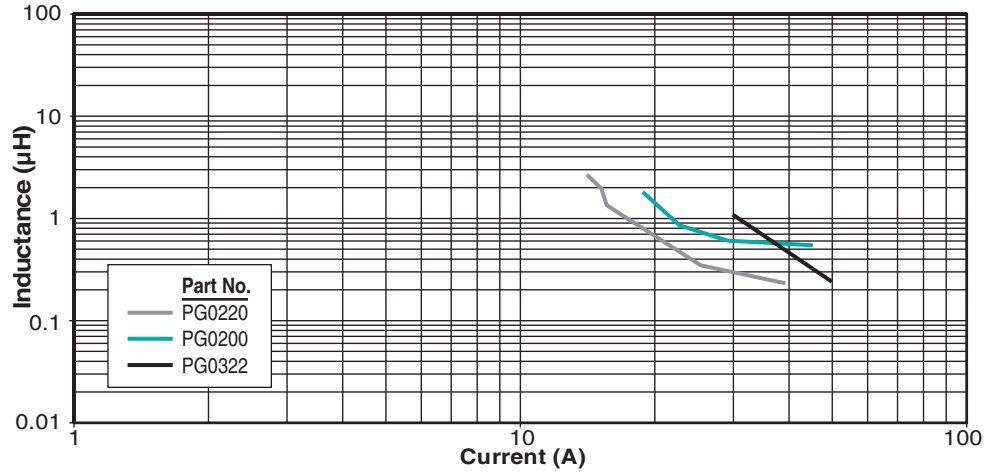

PRODUCT OVERVIEW: HIGH FREQUENCY PLANAR TRANSFORMERS



- Transformers for high-density DC/DC converters (30 W to 300 W)
- Low profile construction
- Low leakage inductance
- Four package sizes and over 400 winding configurations
- Basic/operational insulation

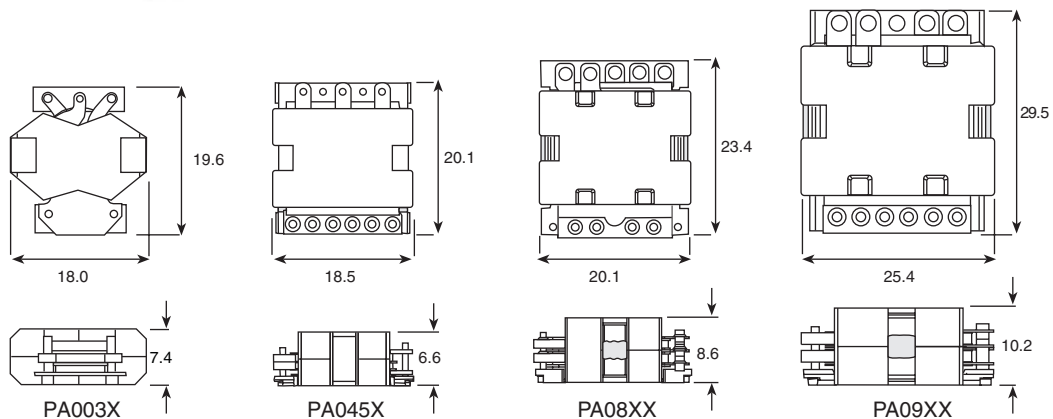

POWER MAGNETICS



PRODUCT OVERVIEW: CURRENT SENSE MAGNETICS

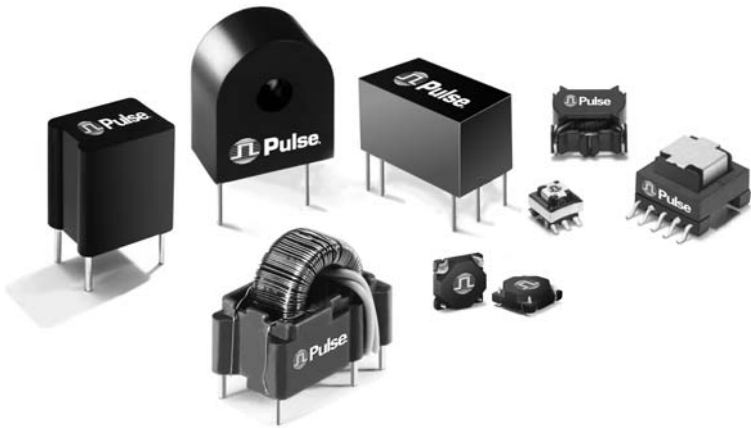

- Up to 35 A
- Wide range of winding ratios
- Versatile and cost-effective

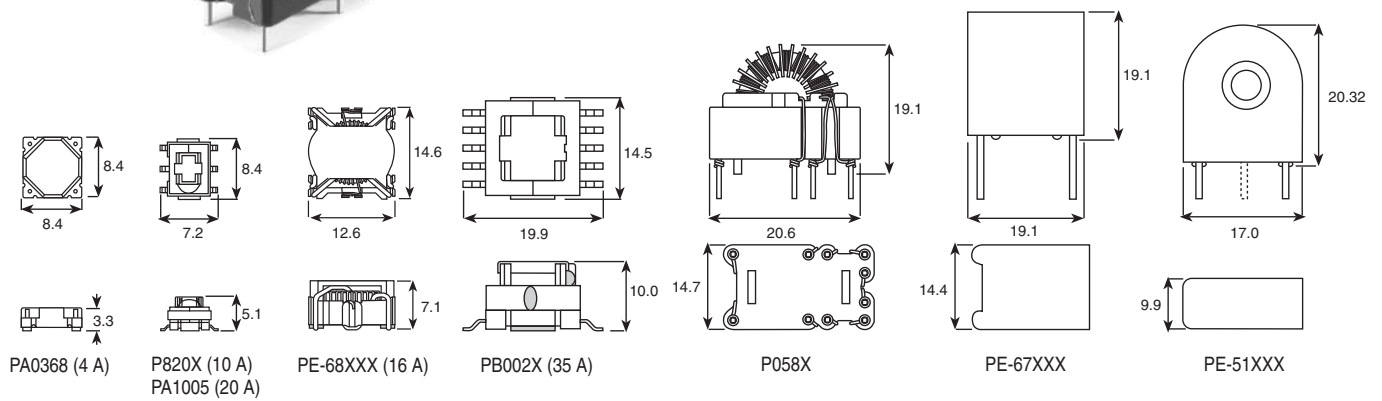

PRODUCT OVERVIEW: HIGH FREQUENCY CONVENTIONAL WOUND TRANSFORMERS

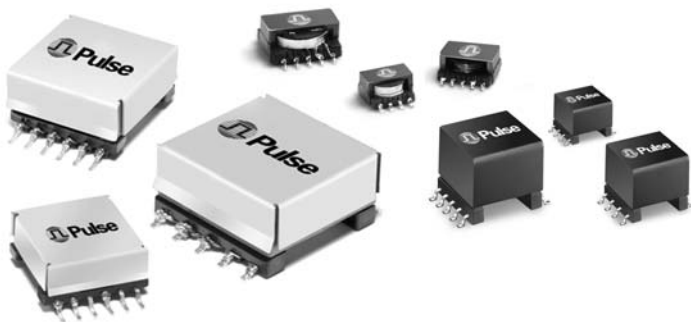

- Transformers for general purpose DC/DC isolated conversion and PoE applications (1 W to 150 W)
- Nine package sizes
- Custom designs available
- Industry standard footprints

POWER MAGNETICS



PRODUCT OVERVIEW: GATE DRIVE TRANSFORMERS



- Smallest footprints in the industry
- Operational, basic and reinforced insulation systems
- Versatile and cost-effective
- Custom winding ratios available

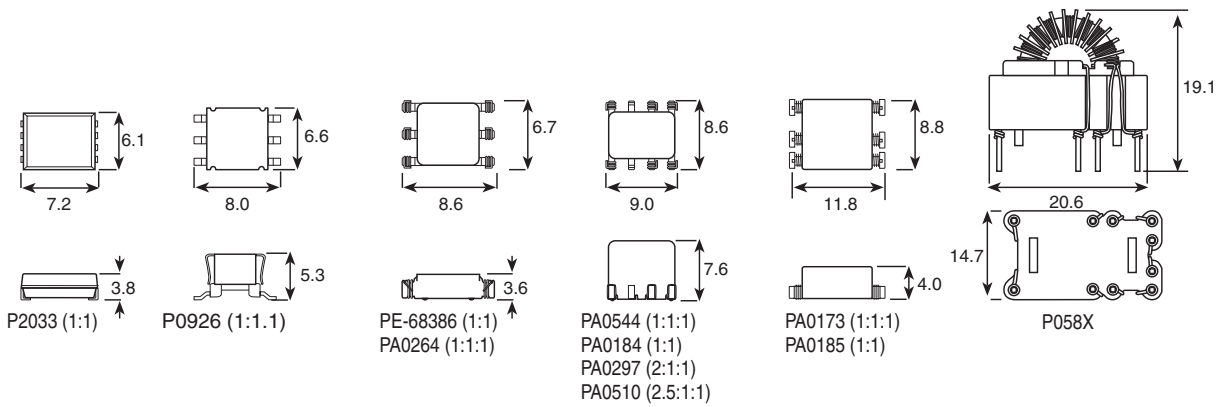

PRODUCT OVERVIEW: COMMON MODE CHOKES



- Up to 24 Adc
- SMT and THT
- AC/DC and DC/DC common mode filters
- Versatile and cost-effective

POWER MAGNETICS



PRODUCT OVERVIEW: LAMINATED TRANSFORMERS

With the addition of encapsulated 50/60 Hz transformers to the existing product line of Pulse open frame transformers, Pulse now offers a complete line of laminated transformers for all your low power, linear transformer requirements. Pulse offers power ratings from 0.08 VA to 175 VA, both fully encapsulated and open frame transformers, and split bobbin designs with a wide variety of domestic and international agency approvals. Pulse is truly the one-stop-shop for all your 50/60 Hz transformer needs.

Another new product line in the Pulse family is the Ignition Transformer, used in heating/ventilation applications for gas/oil burners and white goods. The 2003 European RoHS Directive is being applied to Pulse products, indicated by an NL suffix added to the end of the part number for most products.

This catalog serves as an overview for the Pulse Laminated Transformers product line. Please contact Pulse Power Applications Engineering by e-mail prodinfo_power@pulseeng.com, for more information.

Relative Comparison of Encapsulated vs. Open-frame Laminated Transformers

Type	Heat (same installation size)	Noise	Space	Resistance to Fluids	Resistance to Vibration	Recycling	High Voltage Stability
Encapsulated	++	++	+	++	+	0	++
Open Frame	0	0	0	+	+	++	0

**Mini-Line** - THT* (EE20)

- Up to 0.5 VA
- Temperature class t_a 70°C/B

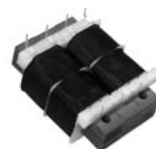
**Low Profile Plug-In**

- Print circuit mounting
- 1500 V, primary to secondary isolation
- Low profile design
- Vacuum impregnated
- Baked resin

**Print-Line** - THT* (EI30-EI54)

- Up to 16 VA
- Temperature class t_a 70°C/B (EI30 / EI42)
- Temperature class t_a 40°C/B (EI48 / EI54)

**Chasis Tran**

- Channel frame mounting
- 2500 V, primary to secondary isolation
- Non-concentric design
- Vacuum impregnated
- Baked resin

**Low Profile** - THT* (UI30-UI39)

- Up to 30 VA
- Temperature class t_a 40°C/B

**International PC Plug-In**

- PC board plug-in mounting
- Dual bobbin, high (4000 V) primary to secondary isolation
- Non-concentric design
- Vacuum impregnated
- Baked resin

**With Mounting Brackets***
(EI42-EI66)

- Up to 50 VA
- Temperature class t_a 70°C/B (EI42)
- Temperature class t_a 40°C/B (EI48/EI66)

**International High Power**

- Chassis mounting
- Dual bobbin; high (4000 V) primary to secondary isolation
- Non-concentric design
- Vacuum impregnated
- Baked resin

**Compact Power Supplies**

- Up to 60 VA
- Temperature class t_a 40°C/B
- Din-rail Mounting

**Split Bobbin, Horizontal Plug-In**

- Print circuit mounting
- 2500 Vrms Hipot
- Non-concentric design
- Vacuum impregnated
- Baked resin

**Ignition Transformers**
Spark-Line - THT

- Up to 23 kV
- Ambient temperature 70°C/B
- Up to 2 HT connections
- Compact design
- Custom designs available

**Concentric, Vertical Profile,**
PC Plug-In

- Industry standard footprint
- 1500 V primary to secondary isolation
- Concentric vertical mount
- Vacuum impregnated
- Baked resin

*Potted under vacuum, two-chamber bobbin, custom designs available upon request, THT = Through Hole.