

Compact, Low-cost Fail-safe SSR that Switches up to 2 Amps

- Unlike conventional solid-state devices, Omron's new fail-safe technology eliminates the need for external fuse or safety circuitry in many applications
- Smaller footprint (approximately 20% smaller than G3MB) is ideal for close PCB mounting applications
- Built in snubber circuit
- VDE versions available

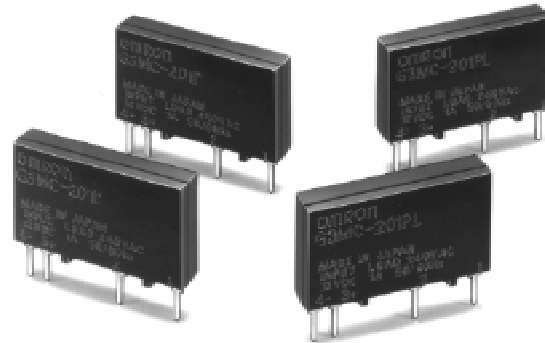

## Ordering Information

To Order: Select the part number and add the desired coil voltage rating, (e.g., G3MC-101P-DC12).

Isolation	Zero-cross function	Built-in snubber circuit	Rated output load	Rated input voltage	Part number
Phototriac	Yes	Yes	1 A at 100 to 120 VAC (75 to 132 VAC)	5 VDC	<b>G3MC-101P</b>
				12 VDC	
				24 VDC	
	No		5 VDC	<b>G3MC-101PL</b>	
					12 VDC
					24 VDC
	Yes		2 A at 100 to 120 VAC (75 to 132 VAC)	<b>G3MC-102P</b>	
					12 VDC
					24 VDC
	No		5 VDC	<b>G3MC-102PL</b>	
					12 VDC
					24 VDC
Yes	1 A at 100 to 240 VAC (75 to 264 VAC)	<b>G3MC-201P</b>			
			12 VDC		
			24 VDC		
No	5 VDC	<b>G3MC-201PL</b>			
			12 VDC		
			24 VDC		
Yes	2 A at 100 to 240 VAC (75 to 264 VAC)	<b>G3MC-202P</b>			
			12 VDC		
			24 VDC		
No	5 VDC	<b>G3MC-202PL</b>			
			12 VDC		
			24 VDC		

Note: VDE versions available. Contact your local Omron representative

# Specifications

## ■ RATINGS (AMBIENT TEMPERATURE 25°C)

### Input

Rated voltage	Operating voltage	Impedance	Voltage levels	
			Must operate voltage	Must dropout voltage
5 VDC	4 to 6 VDC	300Ω ±20%	4 VDC max.	1 VDC min.
12 VDC	9.6 to 14.4 VDC	800Ω ±20%	9.6 VDC max.	
24 VDC	19.2 to 28.8 VDC	1.6kΩ ±20%	19.2 VDC max.	

**Note:** Each model has 5-VDC, 12-VDC, and 24-VDC input versions.

### Output

Part number	Applicable load			
	Rated load voltage	Load voltage range	Load current	Surge current
G3MC-101P(L)	100 to 120 VAC	75 to 132 VAC	0.1 to 1 A	8 A (60 Hz, 1 cycle)
G3MC-201P(L)	100 to 240 VAC	75 to 264 VAC		
G3MC-102P(L)	100 to 120 VAC	75 to 132 VAC	0.1 to 2 A	30 A (60 Hz, 1 cycle)
G3MC-202P(L)	100 to 240 VAC	75 to 264 VAC		

## ■ CHARACTERISTICS

Item	G3MC-101P / G3MC-102P	G3MC-101PL / G3MC-102PL	G3MC-201P / G3MC-202P	G3MC-201PL / G3MC-202PL
Operate time	1/2 of load power source cycle + 1 ms	1 ms max.	1/2 of load power source cycle + 1 ms	1 ms max.
Release time	1/2 of load power source cycle + 1 ms)			
Output ON voltage drop	1.6 V (RMS) max.			
Leakage current	1 mA max. (at 100 VAC)		1.5 mA max. (at 200 VAC)	
Insulation resistance	1,000 MΩ min. (at 500 VDC)			
Dielectric strength	2,500 VAC, 50/60 Hz for 1 min			
Vibration resistance	Malfunction: 10 to 55 Hz, 0.75-mm double amplitude			
Shock resistance	Malfunction: 1,000 m/s <sup>2</sup> (approx. 100G)			
Ambient temperature	Operating: -30°C to 80°C (with no icing or condensation) Storage: -30°C to 100°C (with no icing or condensation)			
Approved standards	UL508 File No. E64562, CSA C22.2 (No. 14, No. 950) File No. LR35535, EN60950 File No. 5925UG			
Ambient humidity	Operating: 45% to 85%			
Weight	Approx. 2.5 g			

# Engineering Data

## ■ G3MC-101P(L), G3MC-201P(L)

**Load Current vs. Ambient Temperature Characteristics**

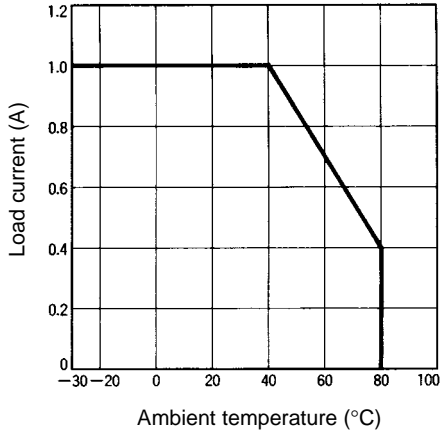

**Inrush Current Resistivity**

Non-repetitive (Keep the inrush current to half the rated value if it occurs repeatedly.)

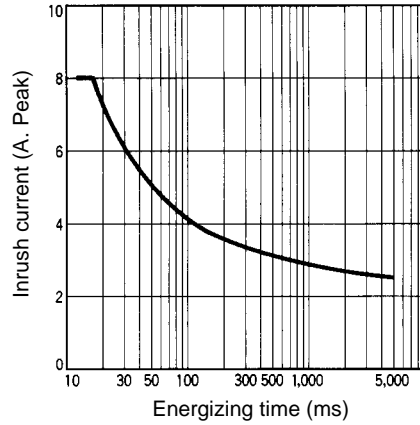

## ■ G3MC-102P(L), G3MC-202P(L)

**Load Current vs. Ambient Temperature Characteristics**

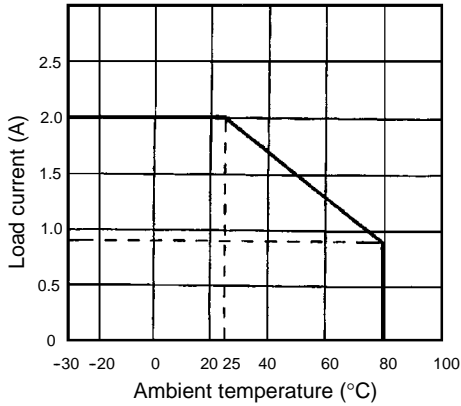

**Inrush Current Resistivity**

Non-repetitive (Keep the inrush current to half the rated value if it occurs repeatedly.)

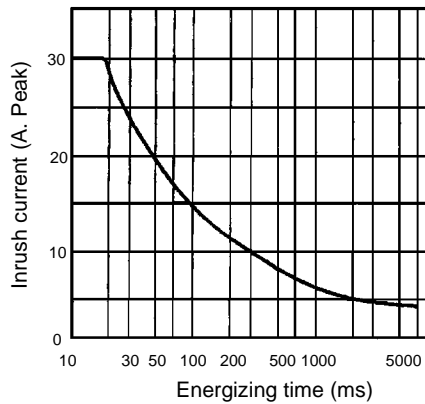

# Dimensions

Unit: mm (inch)

G3MC-101P  
G3MC-101PL  
G3MC-201P  
G3MC-201PL

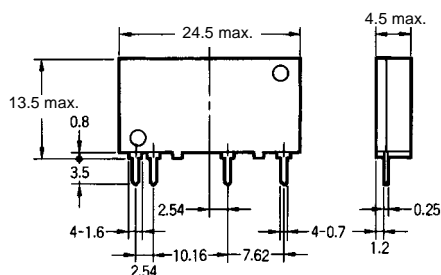
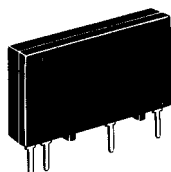

PCB Dimensions  
(Bottom View)

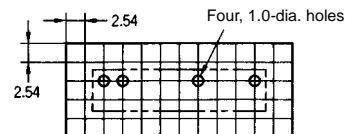

Terminal Arrangement  
(Bottom View)

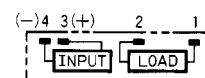

G3MC-102P  
G3MC-102PL  
G3MC-202P  
G3MC-202PL

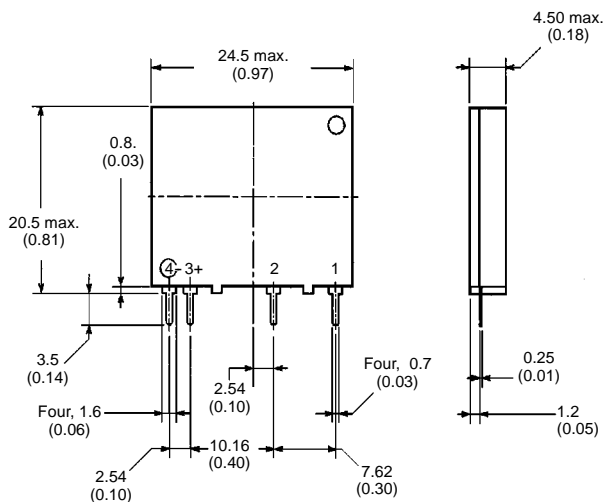
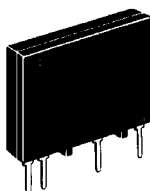

PCB Dimensions  
(Bottom View)

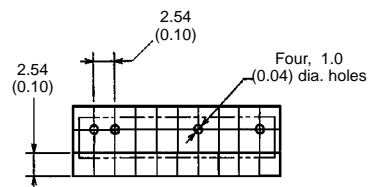

Terminal Arrangement  
(Bottom View)

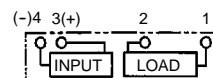

## Precautions

---

### ■ GENERAL PRECAUTIONS

Do not touch the terminals of the SSR while power is being supplied to the SSR. The terminals are charged with the power, and an electric shock may be received by touching the terminals.

The built-in capacitor may have a residual voltage after the SSR is turned off. Be sure to discharge the residual voltage before touching the terminals of the SSR, otherwise an electric shock may be received.

### ■ MOUNTING

1. Make sure that no excessive voltage or current is imposed on or flows to the input or output circuit of the SSR, otherwise the SSR may malfunction or burn.
2. Solder the terminals of the SSR properly under the required soldering conditions. The SSR may be abnormally heated and burn if power is supplied to the terminals soldered incorrectly.
3. Do not short-circuit the load of the SSR while power is supplied to the SSR. Do not short-circuit the power supply through the SSR. The SSR may be damaged, malfunction, or burn if the load or power supply is short-circuited.

### ■ CORRECT USE

The terminals of the SSR are highly heat-conductive. Each terminal must be soldered within 10 s at 260°C or within 5 s at 350°C.

The SSR is of a thin-profile construction. To maintain the vibration resistance of the SSR, make sure that the space between the SSR and PCB is 0.1 mm maximum. Lifting of the PCB can be prevented by setting the hole diameter of the PCBs on both sides slightly smaller than the actual terminal dimension.

Select the model without the zero-cross function when using the Unit for phase control output.

The casing works as a heat sink. When mounting two or more Units

closely, make sure that the Units are properly ventilated by taking ambient temperature rises into consideration. If Units are closely mounted and used in places with no ventilation, the load current of each Unit must be 1/2 of the rated load current.

**NOTE: DIMENSIONS SHOWN ARE IN MILLIMETERS. To convert millimeters to inches divide by 25.4.**

---

**OMRON**<sup>®</sup>**OMRON ELECTRONICS, INC.**

One East Commerce Drive

Schaumburg, IL 60173

**1-800-55-OMRON****OMRON CANADA, INC.**

885 Milner Avenue

Scarborough, Ontario M1B 5V8

**416-286-6465**