

élantec
HIGH PERFORMANCE ANALOG INTEGRATED CIRCUITS

EP2015/EP2015A
Fast Quad PNP Array

ELANTEC INC

T-43-25

Features

- Four independent fast PNP's
- 350 MHz f_t
- Tight V_{BE} matching—1 mV
- Tight H_{fe} matching—5%
- One chip construction with dielectric isolation
- Excellent thermal tracking
- High H_{fe} —150 minimum
- 40V minimum BV_{ceo}
- Each transistor similar to 2N3906
- Pin compatible with TPQ3906 and MPQ3906

Applications

- Current sources
- Current mirrors
- Log amplifiers
- Multipliers

Ordering Information

Part No.	Temp. Range	Package	Outline#
EP2015CN	0°C to +75°C	P-DIP	MDP0031
EP2015ACN	0°C to +75°C	P-DIP	MDP0031
EP2015CJ	0°C to +75°C	CerDIP	MDP0014
EP2015ACJ	0°C to +75°C	CerDIP	MDP0014
EP2015J	-55°C to +125°C	CerDIP	MDP0014
EP2015AJ	-55°C to +125°C	CerDIP	MDP0014
EP2015J/883B	-55°C to +125°C	CerDIP	MDP0014
EP2015AJ/883B	-55°C to +125°C	CerDIP	MDP0014
EP2015AL	-55°C to +125°C	LCC	MDP0007
EP2015L	-55°C to +125°C	LCC	MDP0007
EP2015L/883B	-55°C to +125°C	LCC	MDP0007
EP2015AL/883B	-55°C to +125°C	LCC	MDP0007
EP2015CM	0°C to +75°C	20-Lead SOL	MDP0027

5962-8977501 and 5962-8977502 are the SMD versions of this device.

General Description

The EP2015 family are quad monolithic vertical PNP transistor arrays which offer excellent parametric matching and high speed performance. The 350 MHz f_t provides A.C. performance similar to 2N3906 class devices. Manufactured on Elantec's Complementary Bipolar process, these transistors are electrically isolated from each other by a layer of oxide. The resulting low collector to substrate capacitance allows very high speed performance with minimal crosstalk. In addition, complete D.C. isolation is achieved. Substrate biasing is not required for normal operation, however for optimum high speed performance the substrate should be grounded. One-chip construction insures excellent parameter matching and tracking over temperature.

The low cost EP2015C is specified at 25°C. The EP2015AC is more tightly specified and guaranteed over the commercial temperature range of 0°C to +75°C. The EP2015 and the more stringently specified EP2015A are tested over the full military temperature range of -55°C to +125°C. The EP2015C and EP2015AC are available in either 14-pin plastic dual-in-line or ceramic dual-in-line packages. The EP2015 is also available in chip form for hybrid applications. Its large bonding pads provide for easy automated manufacturing.

For information on a complementary NPN transistor array, see Elantec's EN2016 family data sheet.

Elantec facilities comply with MIL-I-45208A and other applicable quality specifications. For information on Elantec's military processing, request our brochure: *Elantec's Military Processing—Monolithic Products.*

Connection Diagrams

DIP Package

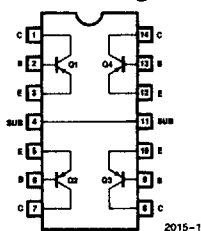

Top View

20-Lead SOL

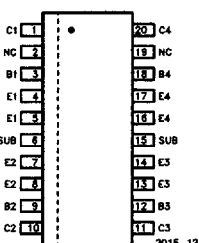

2015-13

LCC

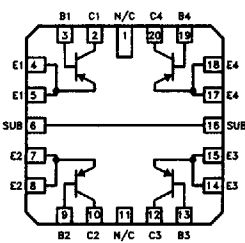

2015-3

Isolation Characteristics Test Circuit

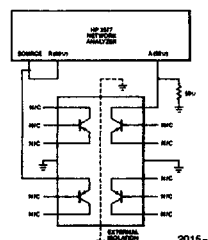

2015-2

EP2015/EP2015A

ELANTEC INC

Fast Quad PNP Array

Absolute Maximum Ratings

P _D	Power Dissipation		T _{ST}	Storage Temperature	-65°C to +150°C
	Each Transistor	500 mW (T _A = 25°C)		Lead Temperature	
	Total Package	1.25W (T _A = 25°C)		SOL Package	
T _A	Operating Temperature Range			Vapor Phase (60 seconds)	215°C
	EP2015A/EP2015	-55°C to +125°C		Infrared (15 seconds)	220°C
	EP2015C/EP2015AC	-0°C to +75°C		(Soldering, <10 seconds)	300°C
T _J	Maximum Junction Temperature		V _{CB}	Max	40V
	CerDIP, Ceramic LCC	175°C	V _{EB}	Max	5V
	Plastic DIP and SOL	150°C	V _{CE}	Max	40V
			I _C	Max	50 mA
			I _B	Max	10 mA

Important Note:

All parameters having Min/Max specifications are guaranteed. The Test Level column indicates the specific device testing actually performed during production and Quality inspection. Elantec performs most electrical tests using modern high-speed automatic test equipment, specifically the LTX77 Series system. Unless otherwise noted, all tests are pulsed tests, therefore T_J = T_C = T_A.

Test Level	Test Procedure
I	100% production tested and QA sample tested per QA test plan QCX0002.
II	100% production tested at T _A = 25°C and QA sample tested at T _A = 25°C, T _{MAX} and T _{MIN} per QA test plan QCX0002.
III	QA sample tested per QA test plan QCX0002.
IV	Parameter is guaranteed (but not tested) by Design and Characterization Data.
V	Parameter is typical value at T _A = 25°C for information purposes only.

Electrical Characteristics

Parameter	Description	Test Conditions	EP2015				EP2015C				Units
			Min	Typ	Max	Test Level	Min	Typ	Max	Test Level	
ΔV _{BE}	(Note 1)	V _{CE} = 4V, I _C = 1 mA T _A = 25°C			5	I			5	I	mV
		T _{MIN} < T _A < T _{MAX}			10	I					mV
ΔH _{fe1}	(Notes 1, 2)	V _{CE} = 1V, I _C = 0.1 mA T _A = 25°C			10	I			10	I	%
		T _{MIN} < T _A < T _{MAX}			20	I					%
ΔH _{fe2}	(Notes 1, 2)	V _{CE} = 1V, I _C = 1 mA T _A = 25°C			10	I			10	I	%
		T _{MIN} < T _A < T _{MAX}			20	I					%
ΔH _{fe3}	(Notes 1, 2)	V _{CE} = 1V, I _C = 10 mA T _A = 25°C			10	I			10	I	%
		T _{MIN} < T _A < T _{MAX}			20	I					%
H _{fe1}	(Note 3)	V _{CE} = 1V, I _C = 0.1 mA T _A = 25°C	75			I	75			I	
		T _{MIN} < T _A < T _{MAX}	30			I					
H _{fe2}	(Note 3)	V _{CE} = 1V, I _C = 1.0 mA T _A = 25°C	75			I	75			I	
		T _{MIN} < T _A < T _{MAX}	30			I					

ELANTEC INC

EP2015/EP2015A

Fast Quad PNP Array

EP2015/EP2015A

Electrical Characteristics — Contd.

Parameter	Description	Test Conditions	EP2015				EP2015C				Units
			Min	Typ	Max	Test Level	Min	Typ	Max	Test Level	
H_{fe3}	(Note 3)	$V_{CE} = 1V, I_C = 10 mA$ $T_A = 25^\circ C$	75			I	75			I	
		$T_{MIN} < T_A < T_{MAX}$	30			I					
V_{BEsat}	(Note 3)	$I_C = 10 mA, I_B = 1 mA$ $T_A = 25^\circ C$			0.90	I			0.90	I	V
		$T_{MIN} < T_A < T_{MAX}$			1.10	I					V
V_{CEsat}	(Note 3)	$I_C = 10 mA, I_B = 1 mA$ $T_A = 25^\circ C$			0.20	I			0.20	I	V
		$T_{MIN} < T_A < T_{MAX}$			0.30	I					V
BV_{ceo}	(Note 3)	$I_C = 1 mA, I_B = 0 mA$ $T_A = 25^\circ C$	40			I	40			I	V
		$T_{MIN} < T_A < T_{MAX}$	40			I					V
BV_{cbo}	(Note 3)	$I_C = 10 \mu A, I_E = 0 mA$ $T_A = 25^\circ C$	40			I	40			I	V
		$T_{MIN} < T_A < T_{MAX}$	40			I					V
BV_{ebo}	(Note 3)	$I_B = 10 \mu A, I_C = 0 mA$ $T_A = 25^\circ C$	5			I	5			I	V
		$T_{MIN} < T_A < T_{MAX}$	5			I					V
I_{cbo}	(Note 3)	$V_{CB} = 30V, I_E = 0 mA$ $T_A = 25^\circ C$			50	I			50	I	nA
		$T_{MIN} < T_A < T_{MAX}$			50	I					nA
I_{cbo}	(Note 3)	$V_{CE} = 4V, I_C = 0 mA$ $T_A = 25^\circ C$			50	I			50	I	nA
		$T_{MIN} < T_A < T_{MAX}$			50	I					nA
f_t	(Note 3)	$V_{CE} = 20V, I_C = 10 mA$ $T_A = 25^\circ C$		350		V		350		V	MHz
r_{BE}	(Notes 3, 4)	$10 \mu A, < I_C < 2 mA$ $T_A = 25^\circ C$		1		V		1		V	Ω

Parameter	Description	Test Conditions	EP2015A				EP2015AC				Units
			Min	Typ	Max	Test Level	Min	Typ	Max	Test Level	
ΔV_{BE}	(Note 1)	$V_{CE} = 4V, I_C = 1 mA$ $T_A = 25^\circ C$			1	I			1	I	mV
		$T_{MIN} < T_A < T_{MAX}$			2	I			2	III	mV
ΔH_{fe1}	(Notes 1, 2)	$V_{CE} = 1V, I_C = 0.1 mA$ $T_A = 25^\circ C$			5	I			5	I	%
		$T_{MIN} < T_A < T_{MAX}$			10	I			10	III	%
ΔH_{fe2}	(Notes 1, 2)	$V_{CE} = 1V, I_C = 1 mA$ $T_A = 25^\circ C$			5	I			5	I	%
		$T_{MIN} < T_A < T_{MAX}$			10	I			10	III	%
ΔH_{fe3}	(Notes 1, 2)	$V_{CE} = 1V, I_C = 10 mA$ $T_A = 25^\circ C$			5	I			5	I	%
		$T_{MIN} < T_A < T_{MAX}$			10	I			10	III	%

EP2015/EP2015A**Fast Quad PNP Array**

ELANTEC INC

Electrical Characteristics — Contd.

Parameter	Description	Test Conditions	EP2015A				EP2015AC				Units
			Min	Typ	Max	Test Level	Min	Typ	Max	Test Level	
H_{fe1}	(Note 3)	$V_{CE} = 1V, I_C = 0.1 \text{ mA}$ $T_A = 25^\circ\text{C}$	150			I	150			I	
		$T_{MIN} < T_A < T_{MAX}$	60			I	60			III	
H_{fe2}	(Note 3)	$V_{CE} = 1V, I_C = 1.0 \text{ mA}$ $T_A = 25^\circ\text{C}$	150			I	150			I	
		$T_{MIN} < T_A < T_{MAX}$	60			I	60			III	
H_{fe3}	(Note 3)	$V_{CE} = 1V, I_C = 10 \text{ mA}$ $T_A = 25^\circ\text{C}$	100			I	100			I	
		$T_{MIN} < T_A < T_{MAX}$	40			I	40			III	
V_{BEsat}	(Note 3)	$I_C = 10 \text{ mA}, I_B = 1 \text{ mA}$ $T_A = 25^\circ\text{C}$			0.90	I			0.90	I	V
		$T_{MIN} < T_A < T_{MAX}$			1.10	I			1.10	III	V
V_{CEsat}	(Note 3)	$I_C = 10 \text{ mA}, I_B = 1 \text{ mA}$ $T_A = 25^\circ\text{C}$			0.20	I			0.20	I	V
		$T_{MIN} < T_A < T_{MAX}$			0.30	I			0.30	III	V
BV_{ceo}	(Note 3)	$I_C = 1 \text{ mA}, I_B = 0 \text{ mA}$ $T_A = 25^\circ\text{C}$	40			I	40			I	V
		$T_{MIN} < T_A < T_{MAX}$	40			I	40			III	V
BV_{cbo}	(Note 3)	$I_C = 10 \mu\text{A}, I_E = 0 \text{ mA}$ $T_A = 25^\circ\text{C}$	40			I	40			I	V
		$T_{MIN} < T_A < T_{MAX}$	40			I	40			III	V
BV_{ebo}	(Note 3)	$I_B = 10 \mu\text{A}, I_C = 0 \text{ mA}$ $T_A = 25^\circ\text{C}$	5			I	5			I	V
		$T_{MIN} < T_A < T_{MAX}$	5			I	5			III	V
I_{cbo}	(Note 3)	$V_{CB} = 30V, I_E = 0 \text{ mA}$ $T_A = 25^\circ\text{C}$			50	I			50	I	nA
		$T_{MIN} < T_A < T_{MAX}$			50	I			50	III	nA
I_{ebo}	(Note 3)	$V_{CE} = 4V, I_C = 0 \text{ mA}$ $T_A = 25^\circ\text{C}$			50	I			50	I	nA
		$T_{MIN} < T_A < T_{MAX}$			50	I			50	III	nA
f_t	(Note 3)	$V_{CE} = 20V, I_C = 10 \text{ mA}$ $T_A = 25^\circ\text{C}$		350		V		350		V	MHz
r_{BE}	(Notes 3, 4)	$10 \mu\text{A} < I_C < 2 \text{ mA}$ $T_A = 25^\circ\text{C}$		1		V		1		V	Ω

Note 1: ΔV_{BE} and ΔH_{fe} are measured between each of six possible pairs of transistors.Note 2: ΔH_{fe} is calculated based on the difference divided by the larger of the two readings.

Note 3: Applies to all four transistors.

Note 4: Estimated from log conformity.

Typical Performance Curves

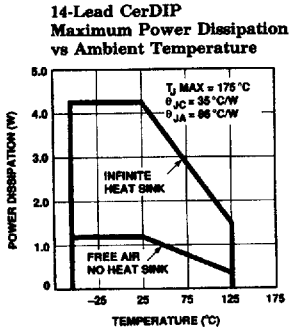

2015-11

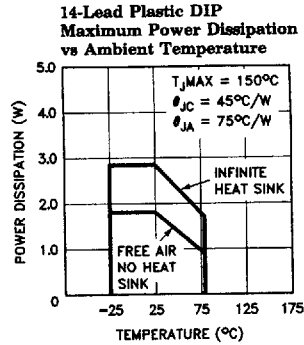

2015-12

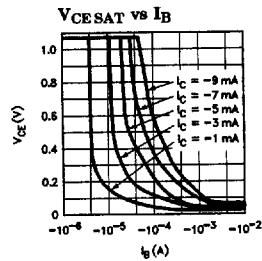
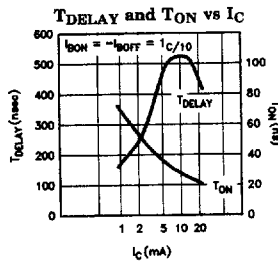
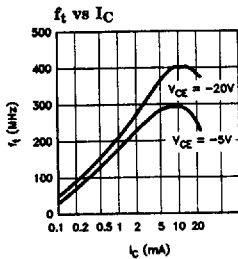
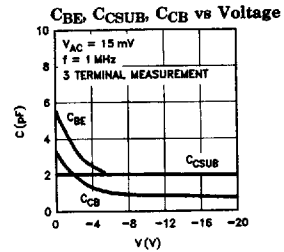
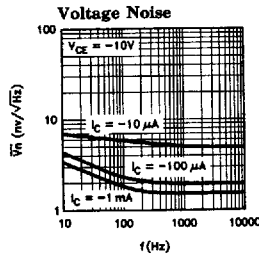
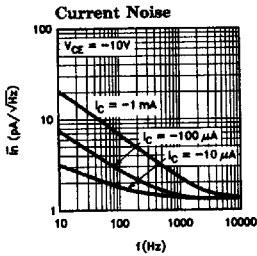

2015-4

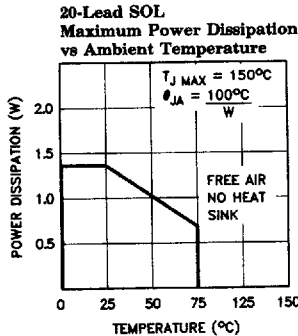

2015-14

EP2015/EP2015A

ELANTEC INC

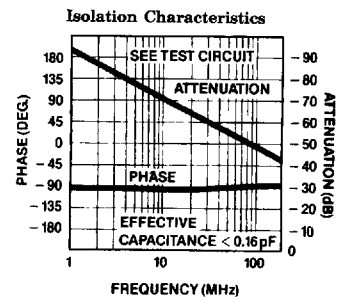
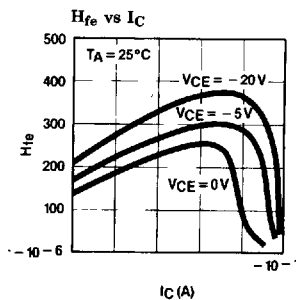
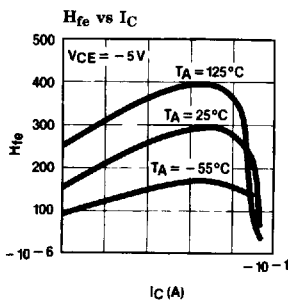
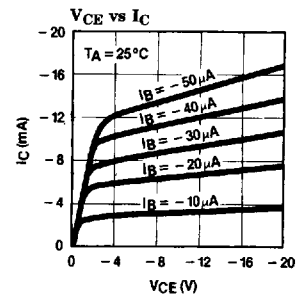
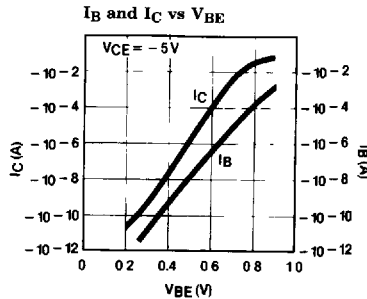
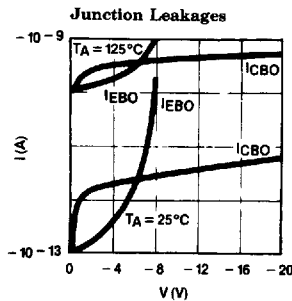
Fast Quad PNP Array**Typical Performance Curves — Contd.**

2015-5

EP2015 PSPICE® Model

IS = 8E-15 BF = 300 VA = 47 IK = 0.03
 XTb = 1.3 BR = 4.5 TF = 0.3N TR = 280N
 RB = 230 RC = 170 ISE = 1E-15 NE = 1.24
 CCS = 2P MS = 0 CJC = 3.7P PC = 0.5 MC = 0.45
 CJE = 5.4P PE = 0.6 ME = 0.33 PTF = 15

Note that for the above model the maximum "soft" saturation collector RC is used. For "hard" saturation modeling set RC ≈ 9.

PSPICE® is a registered trademark of MicroSim Corporation.

Matched NPN transistors have allowed system designers to make NPN current sinks. Now for the first time Elantec's fast matched PNP transistors are available. These make excellent, fast, matched current sources. The advantages of using current sources as active loads, instead of pullup resistors include:

- Faster, linear pull up (Not exponential)
- High output resistance (This increases voltage gain in many applications)

Current Sources and Current Mirrors

Current sinks and current mirrors have long been a tool available to the designer of monolithic ICs.

The Norton and Thevenin equivalent circuits of a current source are:

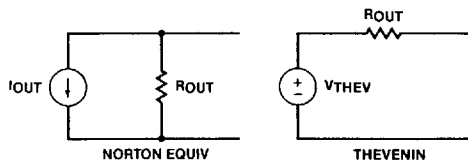

And $V_{THEV} = I_{OUT} \times R_{OUT}$

Four examples of current mirrors are shown, along with some of the advantages and limitations of each topology. For a more thorough discussion see "Analysis and Design of Analog Integrated Circuits" by Grey & Meyer (Wiley 1984), pages 233-247.

All current sources are only as good as the transistors that make them. If the transistors' V_{BE} match is 5 mV the output current would have a 20% error.

All current sources shown can be improved by putting a resistor in series with the topmost emitters. A 250 mV drop across these resistors reduces a 5 mV V_{BE} mismatch to a 2% current error. This has the added benefit of increasing output resistance. Elantec can guarantee a 1 mV V_{BE} match so resistors may not be necessary.

Basic Current Source

The Basic Current Mirror is simple and works well at low currents. Its limitations are low output resistance and it is not as fast as the Wilson.

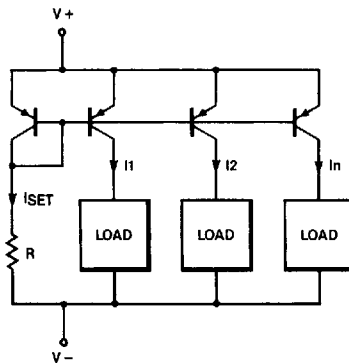

2015-7

$$I_{SET} \approx \frac{((V+) - (V-)) - V_{BE}}{R}$$

$$I_1 = I_2 = I_n = \frac{\beta I_1}{\beta + n + 1}$$

$$R_{OUT} = \frac{V_A}{I_{OUT}} = \frac{\text{EARLY VOLTAGE}}{I_{OUT}} = r_o$$

PNP Wilson Current Mirror

The Wilson is the best Current Mirror for high frequency applications, and it has plenty of output resistance.

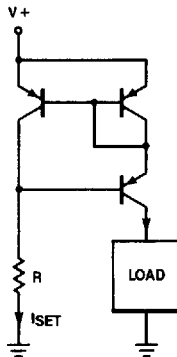

$$I_{OUT} = I_{REF} \left(1 - \frac{2}{\beta^2 + 2\beta + 2} \right)$$

$$R_{OUT} \approx \frac{\beta r_o}{2}$$

$$V_{THEV} \approx \frac{\beta V_A}{2}$$

2015-9

EP2015/EP2015A

ELANTEC INC

Fast Quad PNP Array

Precision Current Source

The Precision Current Source has excellent current match since the error reduction is proportional to β^2 . It is slow to turn off since it has no base turn off current. The turn off speed can be increased by using R_X , at the expense of reduced accuracy.

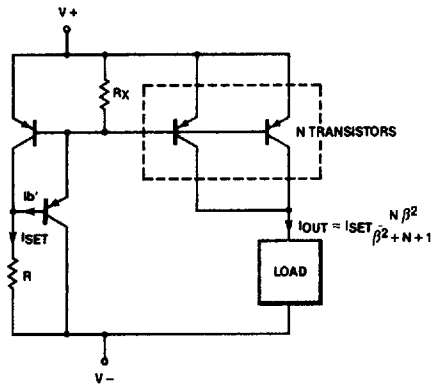

2015-8

$$I_{SET} \approx \frac{((V+) - (V-)) - 2(V_{BE})}{R}$$

$$I_{OUT} \approx I_{SET} \frac{N \beta^2}{\beta^2 + N + 1}$$

$$R_{OUT} = \frac{V_A}{I_{OUT}}$$

Cascode Current Source

The Cascode Current Source is a basic current mirror with a common base transistor in the collector. This makes V_{CE} relatively constant for the mirror transistors and greatly increases the output resistance. This has good high frequency characteristics. Note that Q4 and Q5 can be in a package separate from Q1, Q2 and Q3.

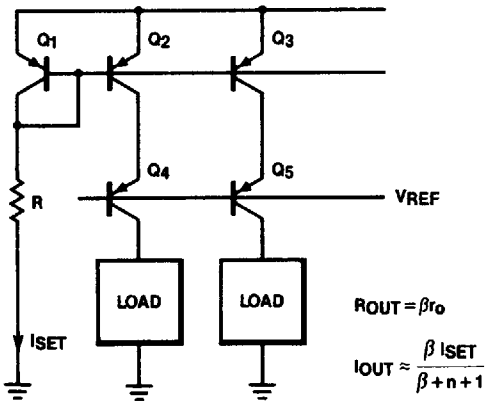

2015-10

ELANTEC INC

EP2015/EP2015A

Fast Quad PNP Array

EP2015/EP2015A

EP2015 Macromodel

```

* Connections:
*      q1c
*      q1b
*      q1e
*      q2c
*      q2b
*      q2e
*      q3c
*      q3b
*      q3e
*      q4c
*      q4b
*      q4e
*
.subckt em2015 1 2 3 7 6 5 8 9 10 14 13 12
* Models
.model ep2015 pnp (is=8e-15 bf=300 va=47 ikf=30mA xtb=1.3 br=4.5 tf=0.3nS
+tr=280nS rb=230 rc=170 ise=1e-15 ne=1.24 ccs=2pF cjc=3.7pF pc=0.5
+mc=0.45 cje=5.4pF pe=0.6 me=0.33 ptf=15)
* Transistors
q1 1 2 3 ep2015
q2 7 6 5 ep2015
q3 8 9 10 ep2015
q4 14 13 12 ep2015
.ends
    
```

EP2015/EP2015A

ELANTEC INC

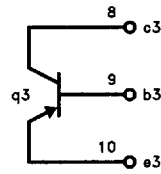
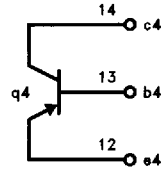
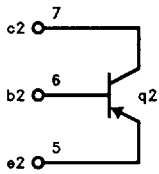
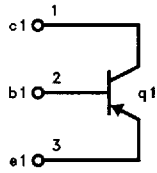
Fast Quad PNP Array**EP2015 Macromodel — Contd.**

2015-16