

## Features

- Low On-Resistance
  - 90 mΩ @  $V_{GS} = 4.5V$
  - 110 mΩ @  $V_{GS} = 2.5V$
  - 200 mΩ @  $V_{GS} = 1.5V$
- Very Low Gate Threshold Voltage
- Low Input Capacitance
- ESD Protected Gate
- Fast Switching Speed
- Lead, Halogen and Antimony Free, RoHS Compliant "Green" Device (Notes 2, 3 and 5)**
- Qualified to AEC-Q101 Standards for High Reliability**

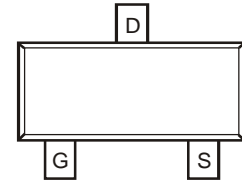

SOT-23

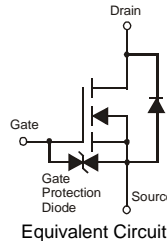

TOP VIEW

## Maximum Ratings @ $T_A = 25^\circ C$ unless otherwise specified

Characteristic	Symbol	Value	Units
Drain-Source Voltage	$V_{DSS}$	30	V
Gate-Source Voltage	$V_{GSS}$	$\pm 8$	V
Drain Current (Note 1)	$I_D$	2.2	A
Pulsed Drain Current (Note 1)	$I_{DM}$	9	A

## Thermal Characteristics @ $T_A = 25^\circ C$ unless otherwise specified

Characteristic	Symbol	Value	Units
Total Power Dissipation (Note 1)	$P_D$	650	mW
Thermal Resistance, Junction to Ambient	$R_{\theta JA}$	192	$^\circ C/W$
Operating and Storage Temperature Range	$T_J, T_{STG}$	-55 to +150	$^\circ C$

## Electrical Characteristics @ $T_A = 25^\circ C$ unless otherwise specified

Characteristic	Symbol	Min	Typ	Max	Unit	Test Condition
<b>OFF CHARACTERISTICS (Note 4)</b>						
Drain-Source Breakdown Voltage	$BV_{DSS}$	30	—	—	V	$V_{GS} = 0V, I_D = 250\mu A$
Zero Gate Voltage Drain Current	$I_{DSS}$	—	—	1	$\mu A$	$V_{DS} = 30V, V_{GS} = 0V$
Gate-Source Leakage	$I_{GSS}$	—	—	$\pm 5$	$\mu A$	$V_{GS} = \pm 8V, V_{DS} = 0V$
<b>ON CHARACTERISTICS (Note 4)</b>						
Gate Threshold Voltage	$V_{GS(th)}$	0.45	—	1.0	V	$V_{DS} = V_{GS}, I_D = 250\mu A$
Static Drain-Source On-Resistance	$R_{DS(on)}$	—	62	90	mΩ	$V_{GS} = 4.5V, I_D = 2.2A$
			70	110		$V_{GS} = 2.5V, I_D = 2A$
			150	200		$V_{GS} = 1.5V, I_D = 0.67A$
Forward Transfer Admittance	$ Y_{fs} $	—	5	—	S	$V_{DS} = 5V, I_D = 2.2A$
Diode Forward Voltage (Note 4)	$V_{SD}$	—	—	0.9	V	$V_{GS} = 0V, I_S = 1A$
<b>DYNAMIC CHARACTERISTICS</b>						
Input Capacitance	$C_{iss}$	—	290	—	pF	$V_{DS} = 10V, V_{GS} = 0V$ $f = 1.0MHz$
Output Capacitance	$C_{oss}$	—	66	—	pF	
Reverse Transfer Capacitance	$C_{rss}$	—	35	—	pF	

- Notes:
- Device mounted on FR-4 PCB, on minimum recommended pad layout on 2oz. Copper pads.
  - No purposefully added lead. Halogen and Antimony Free.
  - Diodes Inc.'s "Green" policy can be found on our website at [http://www.diodes.com/products/lead\\_free/index.php](http://www.diodes.com/products/lead_free/index.php).
  - Short duration pulse test used to minimize self-heating effect.
  - Product manufactured with Green Molding Compound and does not contain Halogens or  $Sb_2O_3$  Fire Retardants.

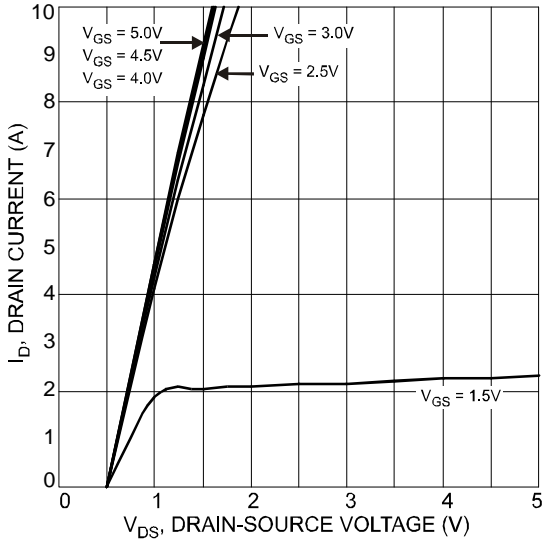

Fig. 1 Typical Output Characteristic

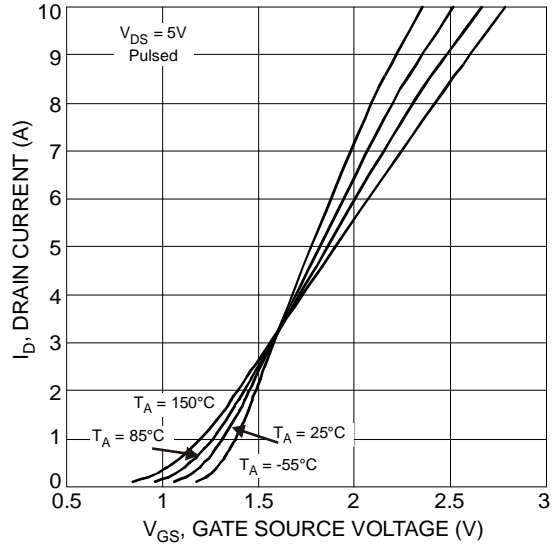

Fig. 2 Typical Transfer Characteristics

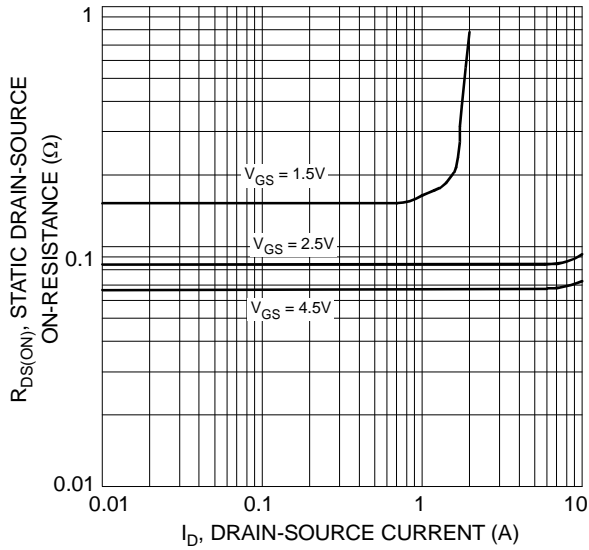

Fig. 3 On-Resistance vs. Drain Current & Gate Voltage

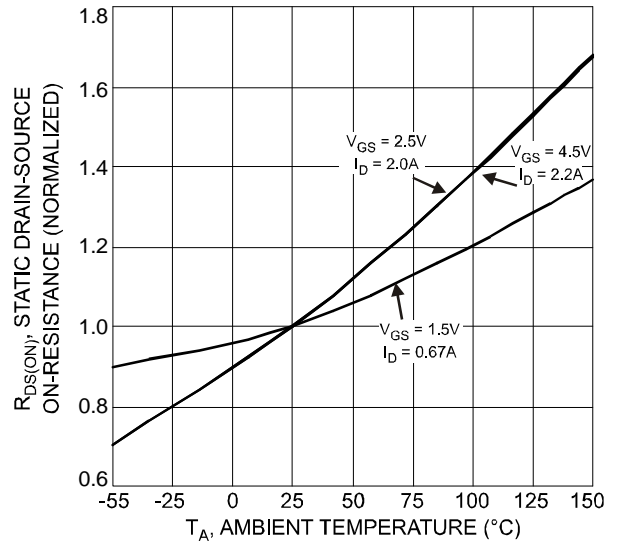

Fig. 4 Normalized Static Drain-Source On-Resistance vs. Ambient Temperature

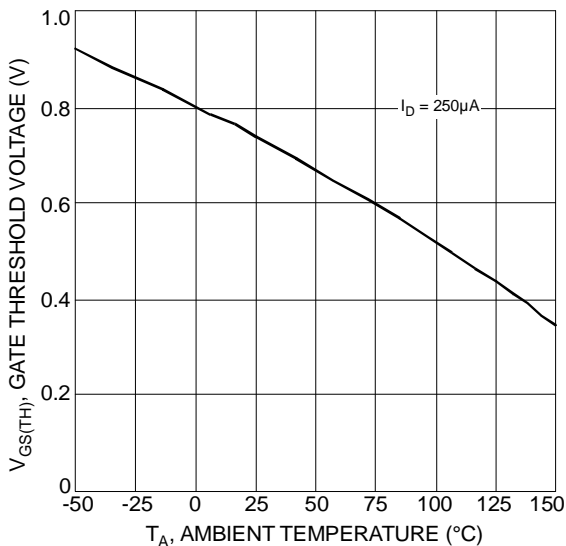

Fig. 5 Gate Threshold Variation vs. Ambient Temperature

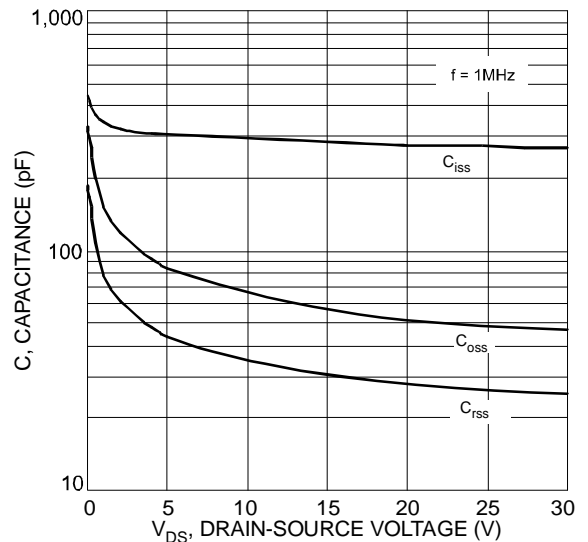

Fig. 6 Typical Total Capacitance

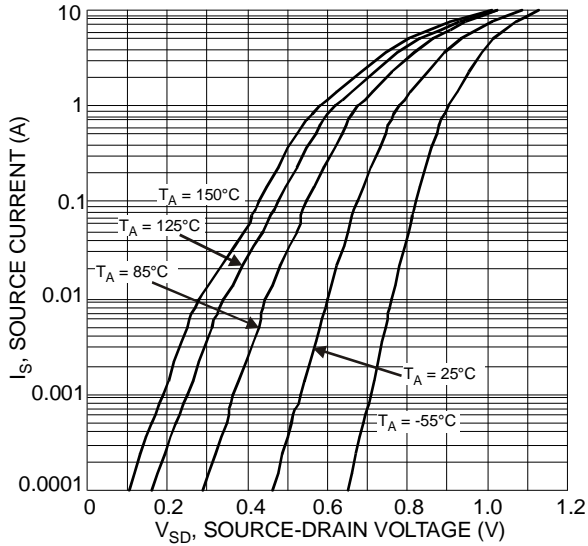

Fig. 7 Reverse Drain Current vs. Source-Drain Voltage

**Ordering Information** (Note 6)

Part Number	Case	Packaging
DMN3200U-7	SOT-23	3000/Tape & Reel

Notes: 6. For packaging details, go to our website at <http://www.diodes.com/datasheets/ap02007.pdf>.

**Marking Information**

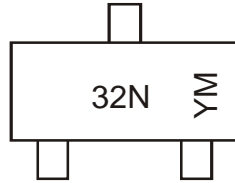

32N = Marking Code  
 YM = Date Code Marking  
 Y = Year ex: U = 2007  
 M = Month ex: 9 = September

Date Code Key

Year	2007	2008	2009	2010	2011	2012
Code	U	V	W	X	Y	Z

Month	Jan	Feb	Mar	Apr	May	Jun	Jul	Aug	Sep	Oct	Nov	Dec
Code	1	2	3	4	5	6	7	8	9	O	N	D

**Package Outline Dimensions**

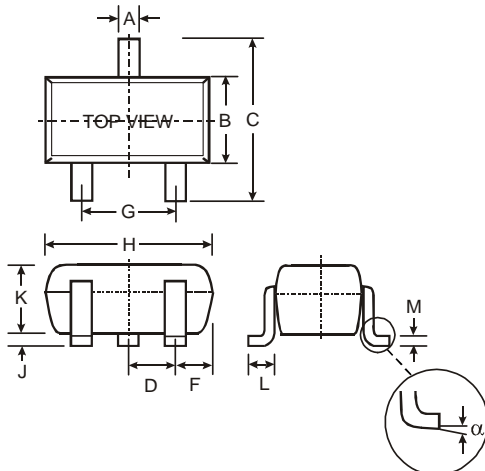

SOT-23		
Dim	Min	Max
A	0.37	0.51
B	1.20	1.40
C	2.30	2.50
D	0.89	1.03
F	0.45	0.60
G	1.78	2.05
H	2.80	3.00
J	0.013	0.10
K	0.903	1.10
L	0.45	0.61
M	0.085	0.180
α	0°	8°
All Dimensions in mm		

**Suggested Pad Layout**

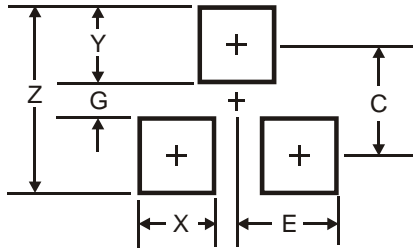

Dimensions	Value (in mm)
Z	3.4
G	0.7
X	0.9
Y	1.4
C	2.0
E	0.9

**IMPORTANT NOTICE**

Diodes Incorporated and its subsidiaries reserve the right to make modifications, enhancements, improvements, corrections or other changes without further notice to any product herein. Diodes Incorporated does not assume any liability arising out of the application or use of any product described herein; neither does it convey any license under its patent rights, nor the rights of others. The user of products in such applications shall assume all risks of such use and will agree to hold Diodes Incorporated and all the companies whose products are represented on our website, harmless against all damages.

**LIFE SUPPORT**

Diodes Incorporated products are not authorized for use as critical components in life support devices or systems without the expressed written approval of the President of Diodes Incorporated.

NEW PRODUCT