

SMF05C, SMF12C, SMF15C, SMF24C

5-Line Transient Voltage Suppressor Array

This 5-line voltage transient suppressor array is designed for application requiring transient voltage protection capability. It is intended for use in over-transient voltage and ESD sensitive equipment such as computers, printers, automotive electronics, networking communication and other applications. This device features a monolithic common anode design which protects five independent lines in a single SC-88 package.

Features

- Protects up to 5-Line in a Single SC-88 Package
- Peak Power Dissipation – 100 W (8 x 20 μ s Waveform)
- ESD Rating of Class 3B (Exceeding 8 kV) per Human Body Model and Class C (Exceeding 400 V) per Machine Model.
- Compliance with IEC 61000-4-2 (ESD) 15 kV (Air), 8 kV (Contact)
- Flammability Rating of UL 94 V-0
- Pb-Free Packages are Available

Applications

- Hand-Held Portable Applications
- Networking and Telecom
- Automotive Electronics
- Serial and Parallel Ports
- Notebooks, Desktops, Servers

www.DataSheet4U.com

MAXIMUM RATINGS ($T_J=25^\circ\text{C}$ unless otherwise specified)

Symbol	Rating	Value	Unit
P_{PK} 1	Peak Power Dissipation 8 x 20 μ s Double Exponential Waveform (Note 1)	100	W
T_J	Operating Junction Temperature Range	-40 to 125	$^\circ\text{C}$
T_{STG}	Storage Temperature Range	-55 to 150	$^\circ\text{C}$
T_L	Lead Solder Temperature (10 s)	260	$^\circ\text{C}$
ESD	Human Body Model (HBM) Machine Model (MM) IEC 61000-4-2 Air (ESD) IEC 61000-4-2 Contact (ESD)	16000 400 15000 15000	V

Maximum ratings are those values beyond which device damage can occur. Maximum ratings applied to the device are individual stress limit values (not normal operating conditions) and are not valid simultaneously. If these limits are exceeded, device functional operation is not implied, damage may occur and reliability may be affected.

1. Nonrepetitive current pulse per Figure 3.



ON Semiconductor[®]

<http://onsemi.com>

SC-88 FIVE TRANSIENT VOLTAGE SUPPRESSOR 100 W PEAK POWER

MARKING DIAGRAM

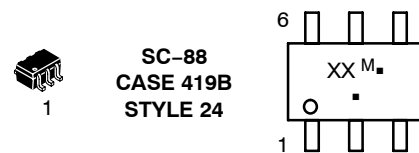

- XX = Specific Device Code
 6J = SMF05C
 6K = SMF12C
 6L = SMF15C
 6M = SMF24C
 M = Date Code
 ■ = Pb-Free Package

PIN ASSIGNMENT

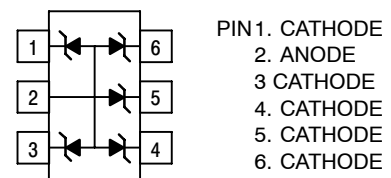

ORDERING INFORMATION

See detailed ordering and shipping information in the package dimensions section on page 4 of this data sheet.

SMF05C, SMF12C, SMF15C, SMF24C

SMF05C ELECTRICAL CHARACTERISTICS ($T_J = 25^\circ\text{C}$ unless otherwise specified)

Parameter	Symbol	Conditions	Min	Typ	Max	Unit
Reverse Working Voltage	V_{RWM}	(Note 2)			5.0	V
Breakdown Voltage	V_{BR}	$I_T = 1\text{ mA}$, (Note 3)	6.2		7.2	V
Reverse Leakage Current	I_R	$V_{RWM} = 5\text{ V}$		0.07	5.0	μA
Clamping Voltage	V_C	$I_{PP} = 5\text{ A}$ (8 x 20 μs Waveform)			9.8	V
Clamping Voltage	V_C	$I_{PP} = 8\text{ A}$ (8 x 20 μs Waveform)			12.5	V
Maximum Peak Pulse Current	I_{PP}	8 x 20 μs Waveform			8.0	A
Capacitance	C_J	$V_R = 0\text{ V}$, $f = 1\text{ MHz}$ (Line to GND)		80	130	pF

SMF12C ELECTRICAL CHARACTERISTICS ($T_J = 25^\circ\text{C}$ unless otherwise specified)

Parameter	Symbol	Conditions	Min	Typ	Max	Unit
Reverse Working Voltage	V_{RWM}	(Note 2)			12	V
Breakdown Voltage	V_{BR}	$I_T = 1\text{ mA}$, (Note 3)	13.3		15	V
Reverse Leakage Current	I_R	$V_{RWM} = 12\text{ V}$		0.01	0.1	μA
Clamping Voltage	V_C	$I_{PP} = 3\text{ A}$ (8 x 20 μs Waveform)			21	V
Clamping Voltage	V_C	$I_{PP} = 6\text{ A}$ (8 x 20 μs Waveform)			23	V
Maximum Peak Pulse Current	I_{PP}	8 x 20 μs Waveform			6.0	A
Capacitance	C_J	$V_R = 0\text{ V}$, $f = 1\text{ MHz}$ (Line to GND)		40	60	pF

SMF15C ELECTRICAL CHARACTERISTICS ($T_J = 25^\circ\text{C}$, unless otherwise specified)

Parameter	Symbol	Conditions	Min	Typ	Max	Unit
Reverse Working Voltage	V_{RWM}	(Note 2)			15	V
Breakdown Voltage	V_{BR}	$I_T = 1\text{ mA}$, (Note 3)	17		19	V
Reverse Leakage Current	I_R	$V_{RWM} = 15\text{ V}$		0.01	1.0	μA
Clamping Voltage	V_C	$I_{PP} = 1\text{ A}$ (8 x 20 μs Waveform)			23	V
Clamping Voltage	V_C	$I_{PP} = 5\text{ A}$ (8 x 20 μs Waveform)			29	V
Maximum Peak Pulse Current	I_{PP}	8 x 20 μs Waveform			5.0	A
Capacitance	C_J	$V_R = 0\text{ V}$, $f = 1\text{ MHz}$ (Line to GND)		33	45	pF

SMF24C ELECTRICAL CHARACTERISTICS ($T_J = 25^\circ\text{C}$, unless otherwise specified)

Parameter	Symbol	Conditions	Min	Typ	Max	Unit
Reverse Working Voltage	V_{RWM}	(Note 2)			24	V
Breakdown Voltage	V_{BR}	$I_T = 1\text{ mA}$, (Note 3)	26.7		32	V
Reverse Leakage Current	I_R	$V_{RWM} = 24\text{ V}$		0.01	1.0	μA
Clamping Voltage	V_C	$I_{PP} = 1\text{ A}$ (8 x 20 μs Waveform)			40	V
Clamping Voltage	V_C	$I_{PP} = 2.5\text{ A}$ (8 x 20 μs Waveform)			44	V
Maximum Peak Pulse Current	I_{PP}	8 x 20 μs Waveform			2.5	A
Capacitance	C_J	$V_R = 0\text{ V}$, $f = 1\text{ MHz}$ (Line to GND)		21	25	pF

2. TVS devices are normally selected according to the working peak reverse voltage (V_{RWM}), which should be equal or greater than the DC or continuous peak operating voltage level.
3. V_{BR} is measured at pulse test current I_T .

SMF05C, SMF12C, SMF15C, SMF24C

TYPICAL PERFORMANCE CURVES

($T_J = 25^\circ\text{C}$ unless otherwise specified)

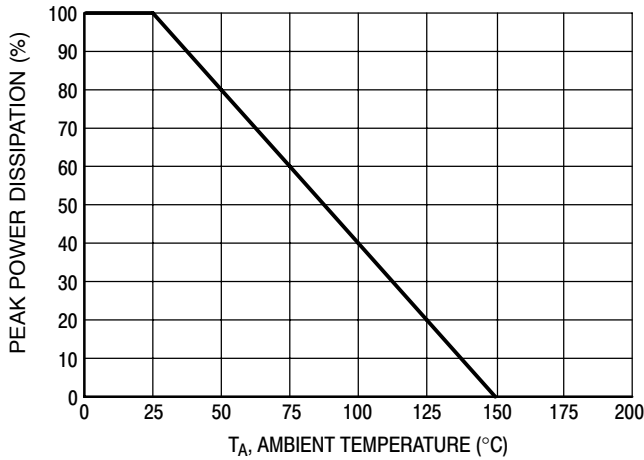

Figure 1. Pulse Derating Curve

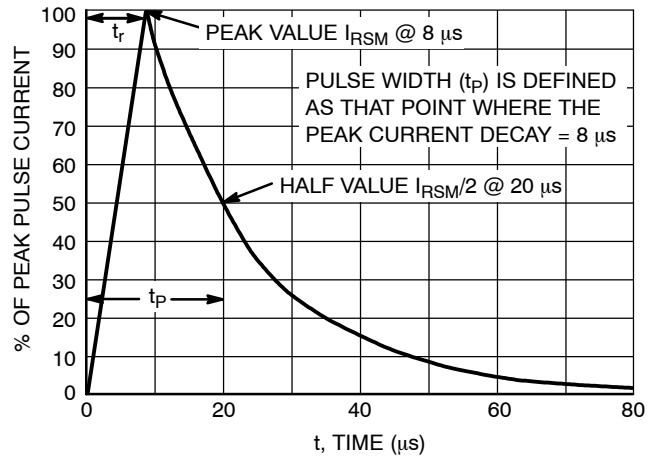

Figure 2. $8 \times 20 \mu\text{s}$ Pulse Waveform

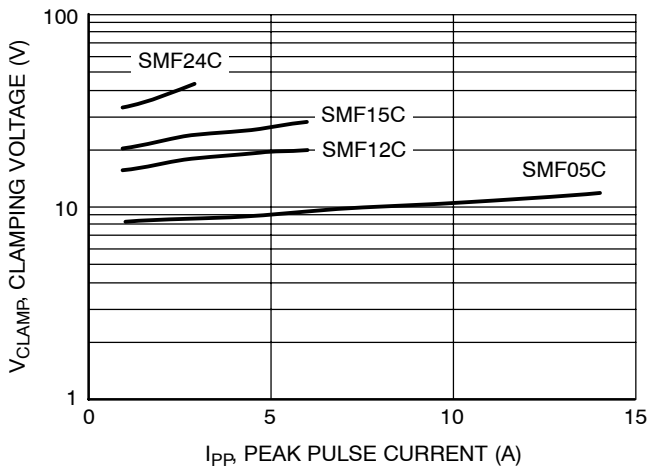

Figure 3. Clamping Voltage vs Peak Pulse Current

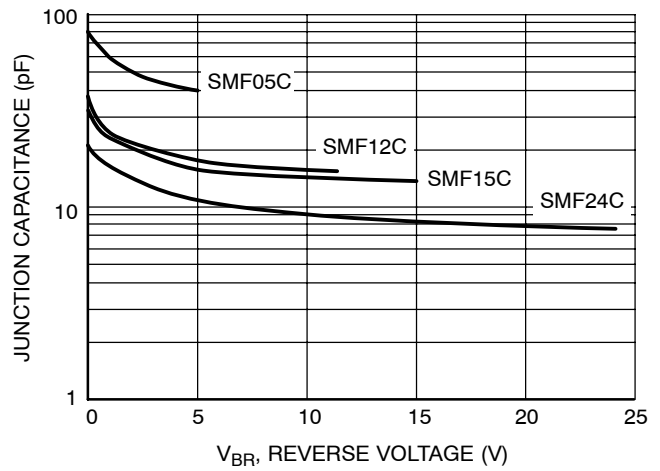

Figure 4. Junction Capacitance vs Reverse Voltage

SMF05C, SMF12C, SMF15C, SMF24C

ORDERING INFORMATION

Device	Package	Shipping†
SMF05CT1	SC-88	3000 / Tape & Reel
SMF05CT1G	SC-88 (Pb-Free)	3000 / Tape & Reel
SMF05CT2*	SC-88	3000 / Tape & Reel
SMF05CT2G*	SC-88 (Pb-Free)	3000 / Tape & Reel
SMF12CT1	SC-88	3000 / Tape & Reel
SMF12CT1G	SC-88 (Pb-Free)	3000 / Tape & Reel
SMF15CT1	SC-88	3000 / Tape & Reel
SMF15CT1G	SC-88 (Pb-Free)	3000 / Tape & Reel
SMF24CT1	SC-88	3000 / Tape & Reel
SMF24CT1G	SC-88 (Pb-Free)	3000 / Tape & Reel

†For information on tape and reel specifications, including part orientation and tape sizes, please refer to our Tape and Reel Packaging Specifications Brochure, BRD8011/D.

*The "T2" suffix refers to an alternate tape & reel orientation.

SMF05C, SMF12C, SMF15C, SMF24C

PACKAGE DIMENSIONS

SC-88/SC70-6/SOT-363
CASE 419B-02
ISSUE V

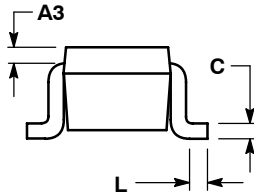
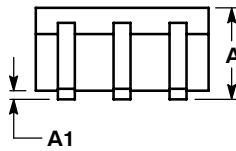
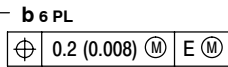
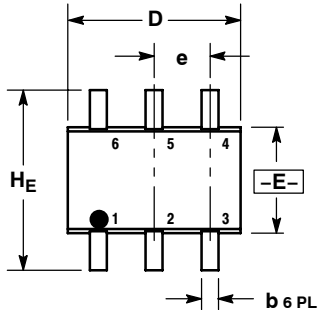

NOTES:

1. DIMENSIONING AND TOLERANCING PER ANSI Y14.5M, 1982.
2. CONTROLLING DIMENSION: INCH.
3. 419B-01 OBSOLETE, NEW STANDARD 419B-02.

DIM	MILLIMETERS			INCHES		
	MIN	NOM	MAX	MIN	NOM	MAX
A	0.80	0.95	1.10	0.031	0.037	0.043
A1	0.00	0.05	0.10	0.000	0.002	0.004
A3	0.20 REF			0.008 REF		
b	0.10	0.21	0.30	0.004	0.008	0.012
C	0.10	0.14	0.25	0.004	0.005	0.010
D	1.80	2.00	2.20	0.070	0.078	0.086
E	1.15	1.25	1.35	0.045	0.049	0.053
e	0.65 BSC			0.026 BSC		
L	0.10	0.20	0.30	0.004	0.008	0.012
HE	2.00	2.10	2.20	0.078	0.082	0.086

STYLE 24:

- PIN 1. CATHODE
- 2. ANODE
- 3. CATHODE
- 4. CATHODE
- 5. CATHODE
- 6. CATHODE

SOLDERING FOOTPRINT*

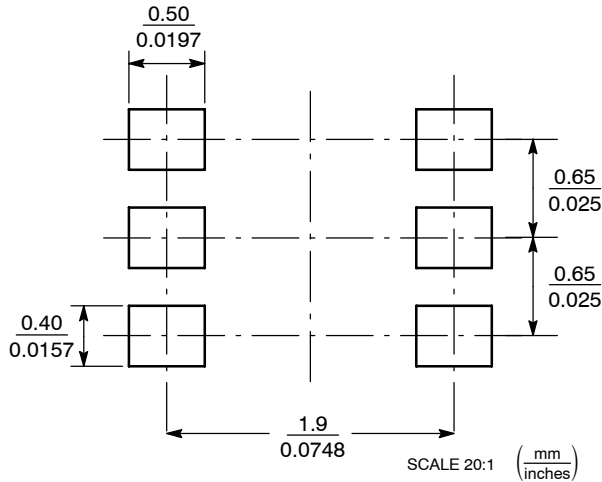

*For additional information on our Pb-Free strategy and soldering details, please download the ON Semiconductor Soldering and Mounting Techniques Reference Manual, SOLDERRM/D.

SMF05C, SMF12C, SMF15C, SMF24C

ON Semiconductor and  are registered trademarks of Semiconductor Components Industries, LLC (SCILLC). SCILLC reserves the right to make changes without further notice to any products herein. SCILLC makes no warranty, representation or guarantee regarding the suitability of its products for any particular purpose, nor does SCILLC assume any liability arising out of the application or use of any product or circuit, and specifically disclaims any and all liability, including without limitation special, consequential or incidental damages. "Typical" parameters which may be provided in SCILLC data sheets and/or specifications can and do vary in different applications and actual performance may vary over time. All operating parameters, including "Typicals" must be validated for each customer application by customer's technical experts. SCILLC does not convey any license under its patent rights nor the rights of others. SCILLC products are not designed, intended, or authorized for use as components in systems intended for surgical implant into the body, or other applications intended to support or sustain life, or for any other application in which the failure of the SCILLC product could create a situation where personal injury or death may occur. Should Buyer purchase or use SCILLC products for any such unintended or unauthorized application, Buyer shall indemnify and hold SCILLC and its officers, employees, subsidiaries, affiliates, and distributors harmless against all claims, costs, damages, and expenses, and reasonable attorney fees arising out of, directly or indirectly, any claim of personal injury or death associated with such unintended or unauthorized use, even if such claim alleges that SCILLC was negligent regarding the design or manufacture of the part. SCILLC is an Equal Opportunity/Affirmative Action Employer. This literature is subject to all applicable copyright laws and is not for resale in any manner.

PUBLICATION ORDERING INFORMATION

LITERATURE FULFILLMENT:

Literature Distribution Center for ON Semiconductor
P.O. Box 61312, Phoenix, Arizona 85082-1312 USA
Phone: 480-829-7710 or 800-344-3860 Toll Free USA/Canada
Fax: 480-829-7709 or 800-344-3867 Toll Free USA/Canada
Email: orderlit@onsemi.com

N. American Technical Support: 800-282-9855 Toll Free
USA/Canada

Japan: ON Semiconductor, Japan Customer Focus Center
2-9-1 Kamimeguro, Meguro-ku, Tokyo, Japan 153-0051
Phone: 81-3-5773-3850

ON Semiconductor Website: <http://onsemi.com>

Order Literature: <http://www.onsemi.com/litorder>

For additional information, please contact your
local Sales Representative.