



6 Lake Street, Lawrence, MA 01841
 1-800-446-1158 / (978) 620-2600 / Fax: (978) 689-0803
 Website: <http://www.microsemi.com>

PRELIMINARY TECHNICAL DATA SHEET

Gort Road Business Park, Ennis, Co. Clare, Ireland
 Tel: +353 (0) 65 6840044 Fax: +353 (0) 65 6822298

SILICON CARBIDE DUAL SCHOTTKY POWER RECTIFIER

DEVICES

MSiCSN10120CC MSiCSN10120CA MSiCSN10120D

MSiCSS10120CC MSiCSS10120CA MSiCSS10120D

**10A / 1200V
 Silicon Carbide
 Dual Schottky Rectifier**

ABSOLUTE MAXIMUM RATINGS ($T_C = +25^\circ\text{C}$ unless otherwise noted)

Parameters / Test Conditions	Symbol	Value	Unit
Peak Repetitive Reverse Voltage	V_{RWM}	1200	V
Surge Peak Reverse Voltage	V_{RSM}	1200	V
DC Blocking Voltage	V_{DC}	1200	V
Average Forward Current, 25°C	I_o	10	Apk
Peak Surge Forward Current @ $t_p = 8.3\text{ms}$, half sinewave, $I_o = 0$; $V_{RM} = 0$	I_{FSM}	50	Apk
Thermal Resistance, Junction to Case	$R_{\theta jc}$		$^\circ\text{C}/\text{W}$
Thermal Resistance, Junction to Ambient	$R_{\theta ja}$		$^\circ\text{C}/\text{W}$
Operating Junction Temperature	T_j	-65°C to $+225$	$^\circ\text{C}$
Storage Temperature	T_{stg}	-65°C to $+225$	$^\circ\text{C}$

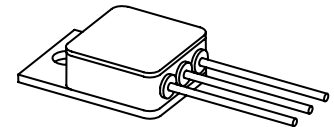

**TO-257
 MSiCSN10120** _____

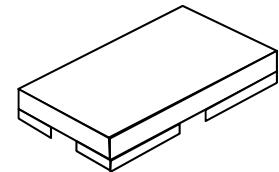

**U-3
 (SURFACE MOUNT: SMD.5)
 MSiCSS10120** _____

ELECTRICAL CHARACTERISTICS ($T_A = +25^\circ\text{C}$, unless otherwise noted) (Per Diode)

Parameters / Test Conditions	Symbol	Min.	Max.	Unit
Forward Voltage* $I_F = 1\text{A}, T_j = 25^\circ\text{C}$ $I_F = 2.5\text{A}, T_j = 25^\circ\text{C}$ $I_F = 5.0\text{A}, T_j = 25^\circ\text{C}$ $I_F = 10.0\text{A}, T_j = 25^\circ\text{C}$	V_F		1.0 1.2 1.4 1.8	V
Reverse Current $V_R = 1200\text{V}, T_j = 25^\circ\text{C}$ $V_R = 1200\text{V}, T_j = 175^\circ\text{C}$	I_R		100 200	μA
Junction Capacitance $V_R = 0\text{V}$ $f = 1\text{MHz}$	C_j		1200	pF

* Pulse test: Pulse width 300 μsec , Duty cycle 2%

Note:

- Derate linearly @ tbd

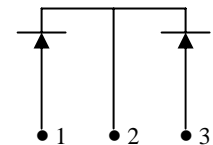

CC - COMMON CATHODE

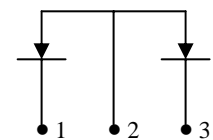

CA - COMMON ANODE

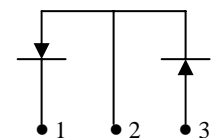

D - DOUBLER

PACKAGE DIMENSIONS

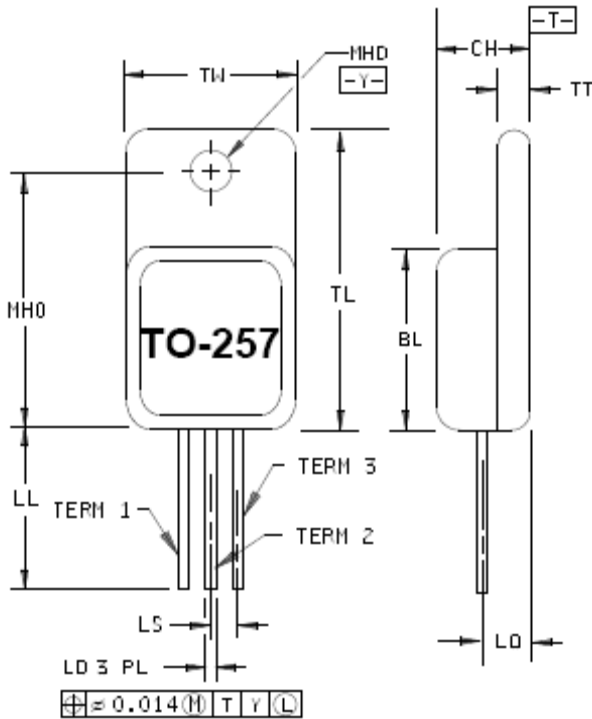

Ltr	Dimensions			
	Millimeters		Inches	
	Min	Max	Min	Max
BL	10.41	10.92	.410	.430
CH	4.83	5.08	.190	.200
LD	0.64	0.89	.025	.035
LL	12.82	15.11	.505	.595
LO	3.05 BSC		.120 BSC	
LS	2.54 BSC		.100 BSC	
MHD	3.56	3.81	.140	.150
MHO	13.39	13.64	.527	.537
TL	16.38	16.89	.6450	.665
TT	0.89	1.14	.035	.045
TW	10.41	10.67	.410	.420
TERM 1	SEE SCHEMATIC			
TERM 2	SEE SCHEMATIC			
TERM 3	SEE SCHEMATIC			

SCHEMATIC

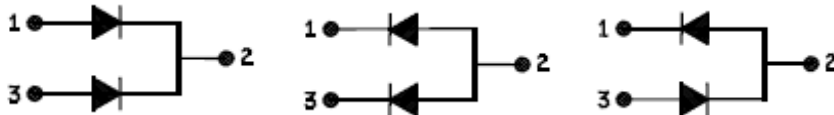

NOTE:

1. Dimensions are in millimeters.
2. Inch equivalents are given for general information only.
3. Glass meniscus included in dimension TL and BL

FIGURE 1 – Dimensions and configuration (TO-257AA)

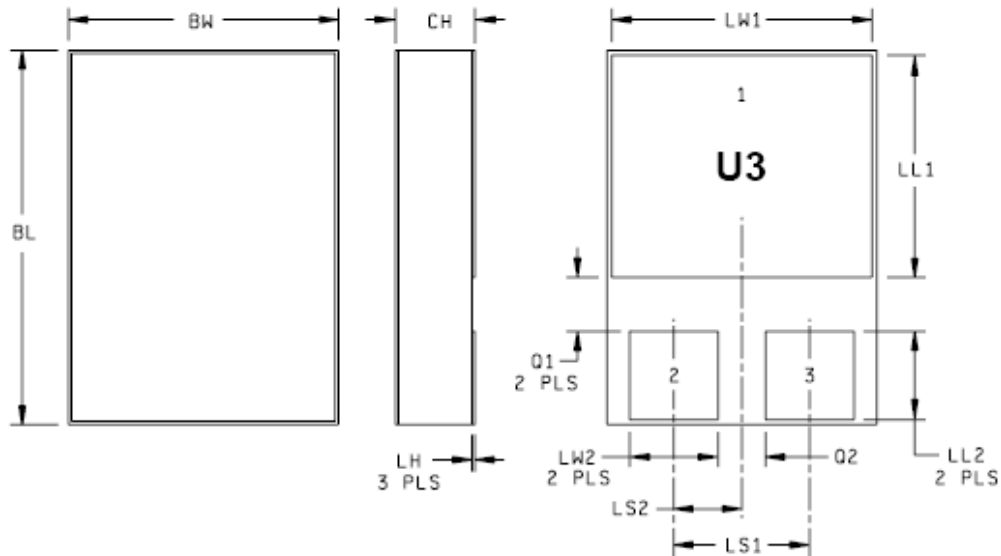

NOTE:

1. Dimensions are in inches.
2. Millimeters are given for general information only.
3. In accordance with ASME Y14.5M, diameters are equivalent to ϕ x symbology.

Symbol	Dimensions			
	Inches		Millimeters	
	Min	Max	Min	Max
BL	.395	.405	10.04	10.28
BW	.291	.301	7.40	7.64
CH	.1085	.1205	2.76	3.06
LH	.010	.020	0.25	0.51
LW1	.281	.291	7.14	7.41
LW2	.090	.100	2.29	2.54
LL1	.220	.230	5.59	5.84
LL2	.115	.125	2.93	3.17
LS1	.150 BSC		3.81 BSC	
LS2	.075 BSC		1.91 BSC	
Q1	.030		0.762	
Q2	.030		0.762	

SCHEMATIC

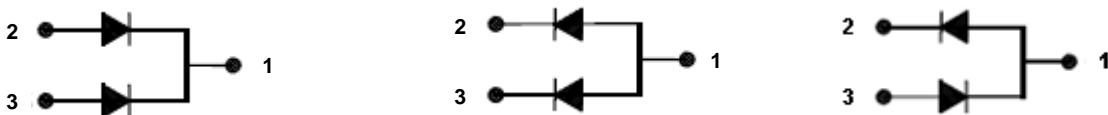

FIGURE 2 – Physical dimensions, surface mount U3 (SMD.5)