

## FAST RECOVERY RECTIFIER DIODES

- VERY LOW REVERSE RECOVERY TIME
- VERY LOW SWITCHING LOSSES
- LOW NOISE TURN-OFF SWITCHING

### SUITABLE APPLICATIONS

- FREE WHEELING DIODE IN CONVERTERS AND MOTOR CONTROL CIRCUITS
- RECTIFIER IN S.M.P.S.

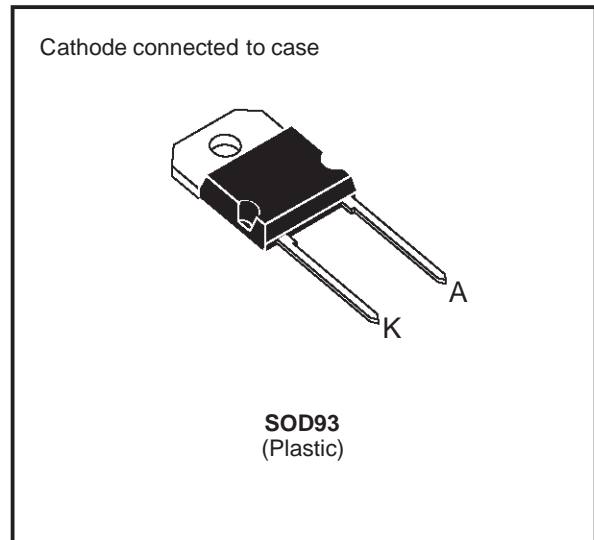

### ABSOLUTE RATINGS (limiting values)

Symbol	Parameter		Value	Unit
$I_{FRM}$	Repetitive Peak Forward Current	$t_p \leq 10\mu s$	500	A
$I_{F(RMS)}$	RMS Forward Current		50	A
$I_{F(AV)}$	Average Forward Current	$T_c = 100^\circ C$ $\delta = 0.5$	30	A
$I_{FSM}$	Surge non Repetitive Forward Current	$t_p = 10ms$ Sinusoidal	350	A
P	Power Dissipation	$T_c = 100^\circ C$	50	W
$T_{stg}$ $T_j$	Storage and Junction Temperature Range		- 40 to + 150 - 40 to + 150	$^\circ C$

Symbol	Parameter	Value	Unit
$V_{RRM}$	Repetitive Peak Reverse Voltage	400	V
$V_{RSM}$	Non Repetitive Peak Reverse Voltage	440	V

### THERMAL RESISTANCE

Symbol	Parameter	Value	Unit
$R_{th(j-c)}$	Junction-case	1	$^\circ C/W$

**ELECTRICAL CHARACTERISTICS**

STATIC CHARACTERISTICS

Symbol	Test Conditions		Min.	Typ.	Max.	Unit
I <sub>R</sub>	T <sub>j</sub> = 25°C	V <sub>R</sub> = V <sub>RRM</sub>			35	μA
	T <sub>j</sub> = 100°C				6	mA
V <sub>F</sub>	T <sub>j</sub> = 25°C	I <sub>F</sub> = 30A			1.5	V
	T <sub>j</sub> = 100°C				1.4	

RECOVERY CHARACTERISTICS

Symbol	Test Conditions			Min.	Typ.	Max.	Unit
t <sub>rr</sub>	T <sub>j</sub> = 25°C	I <sub>F</sub> = 1A	di <sub>F</sub> /dt = - 15A/μs			100	ns
		I <sub>F</sub> = 0.5A	I <sub>R</sub> = 1A			I <sub>rr</sub> = 0.25A	

TURN-OFF SWITCHING CHARACTERISTICS (Without Series Inductance)

Symbol	Test Conditions		Min.	Typ.	Max.	Unit
t <sub>IRM</sub>	di <sub>F</sub> /dt = - 120A/μs	V <sub>CC</sub> = 200 V I <sub>F</sub> = 30A L <sub>p</sub> ≤ 0.05μH T <sub>j</sub> = 100°C See figure 11			75	ns
	di <sub>F</sub> /dt = - 240A/μs			50		
I <sub>RM</sub>	di <sub>F</sub> /dt = - 120A/μs				9	A
	di <sub>F</sub> /dt = - 240A/μs			12		

TURN-OFF OVERVOLTAGE COEFFICIENT (With Series Inductance)

Symbol	Test Conditions			Min.	Typ.	Max.	Unit
$C = \frac{V_{RP}}{V_{CC}}$	T <sub>j</sub> = 100°C	V <sub>CC</sub> = 60V	I <sub>F</sub> = I <sub>F(AV)</sub> See figure 12		3.3		
	di <sub>F</sub> /dt = - 30A/μs	L <sub>p</sub> = 1μH					

To evaluate the conduction losses use the following equations:

$$V_F = 1.1 + 0.0095 I_F \quad P = 1.1 \times I_{F(AV)} + 0.0095 I_{F(RMS)}^2$$

Figure 1. Low frequency power losses versus average current

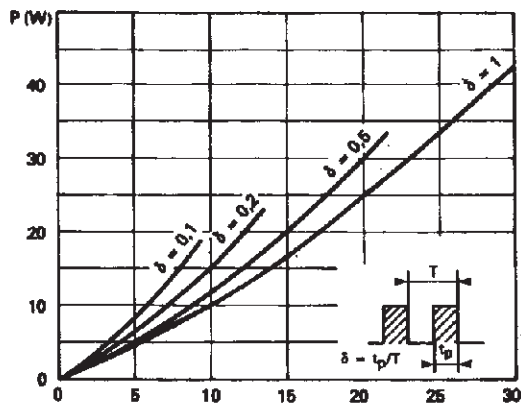

Figure 2. Peak current versus form factor

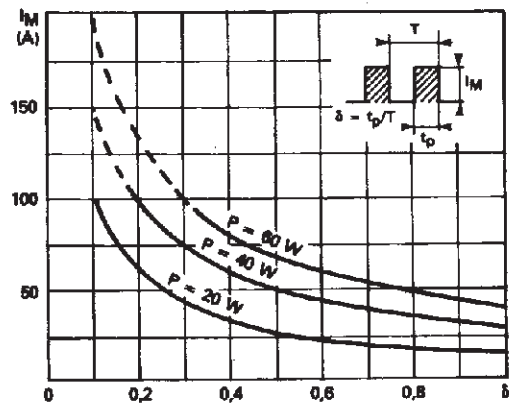

Figure 3. Non repetitive peak surge current versus overload duration

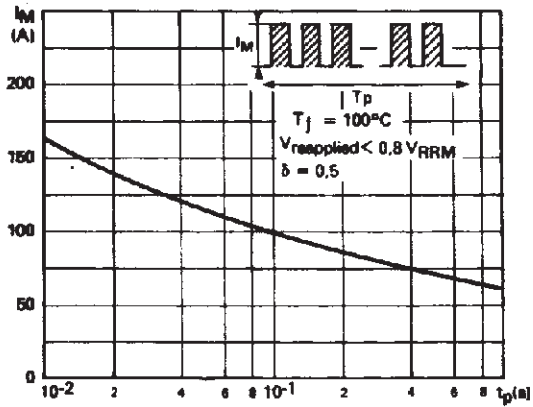

Figure 4. Thermal impedance versus pulse width

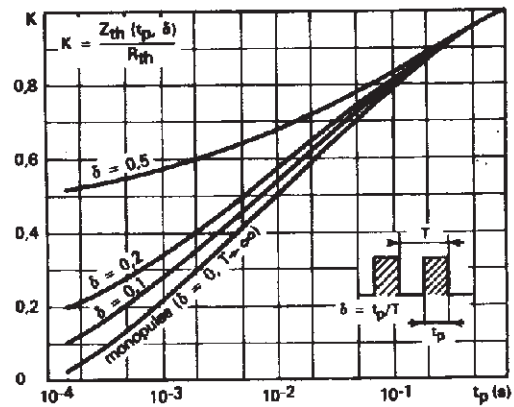

Figure 5. Voltage drop versus forward current

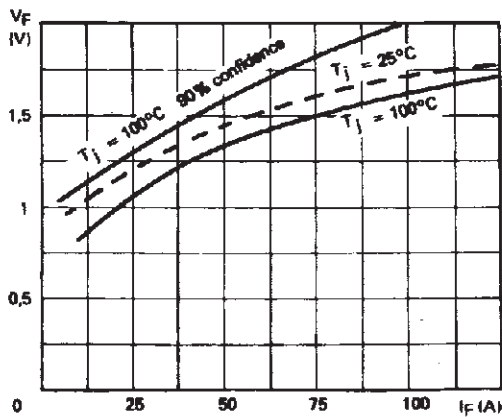

Figure 6. Recovery charge versus di\_F/dt

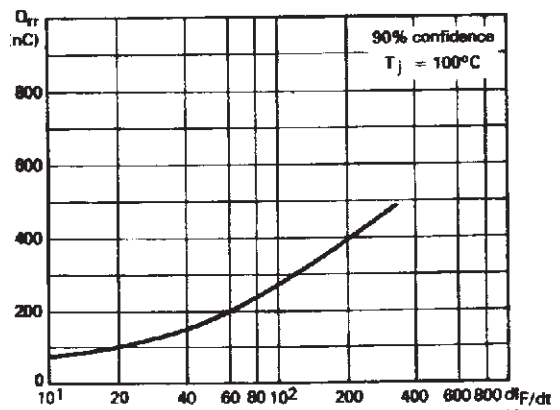

Figure 7. Recovery time versus di\_F/dt

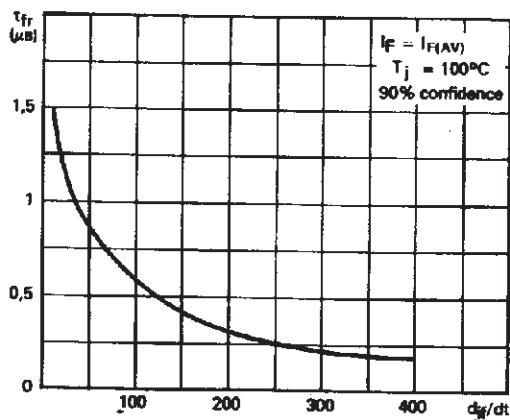

Figure 8. Peak reverse current versus di\_F/dt

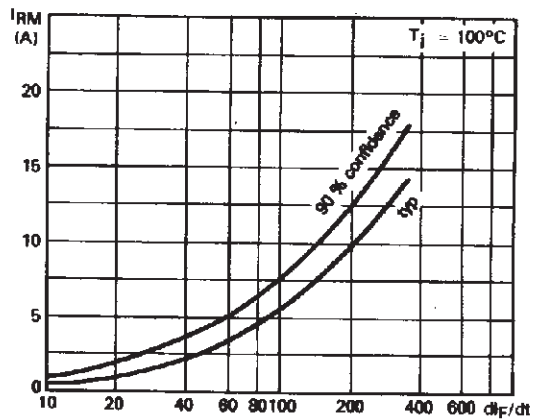

Figure 9. Peak forward voltage versus  $di_F/dt$ .

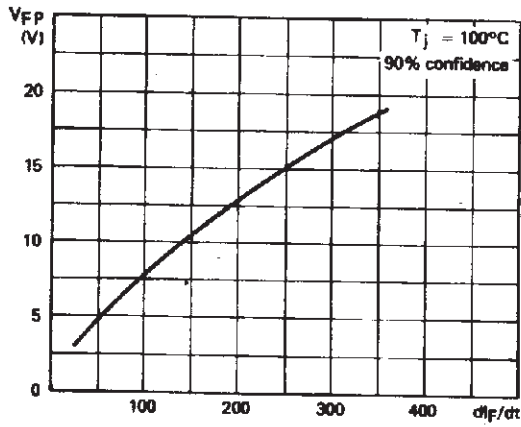

Figure 10. Dynamic parameters versus junction temperature.

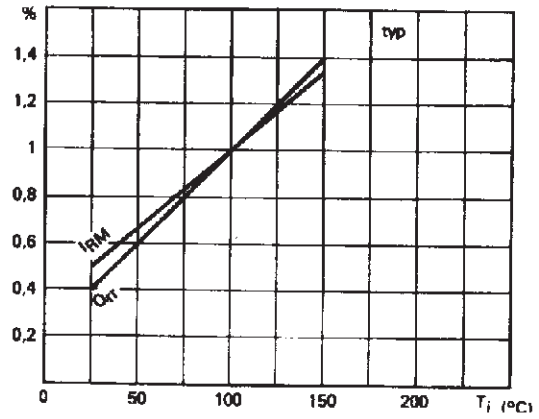

Figure 11. Turn-off switching characteristics (without series inductance).

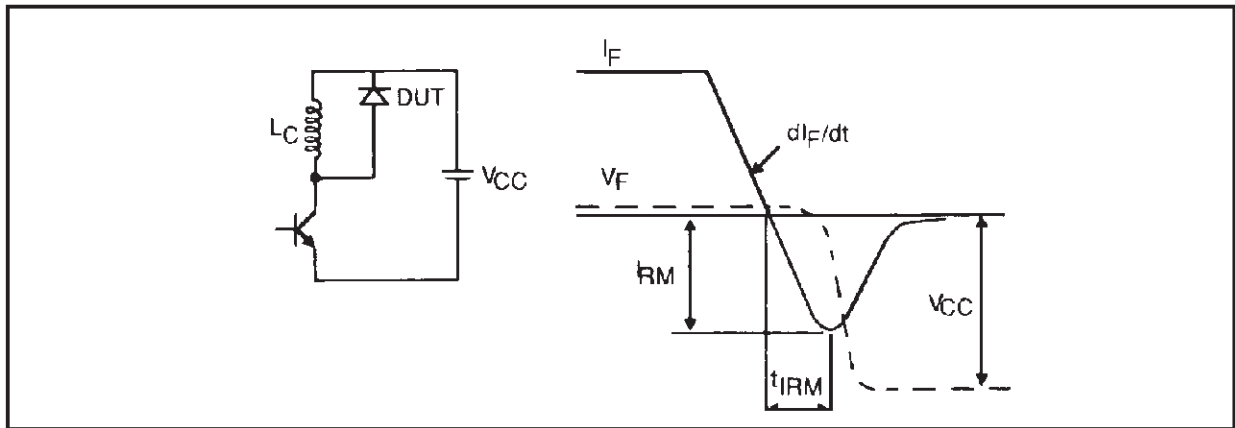
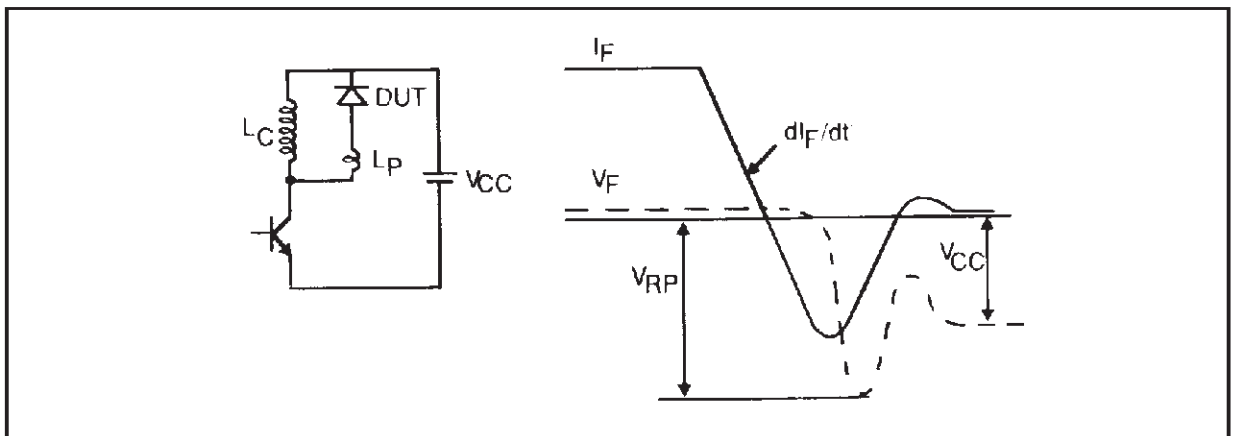
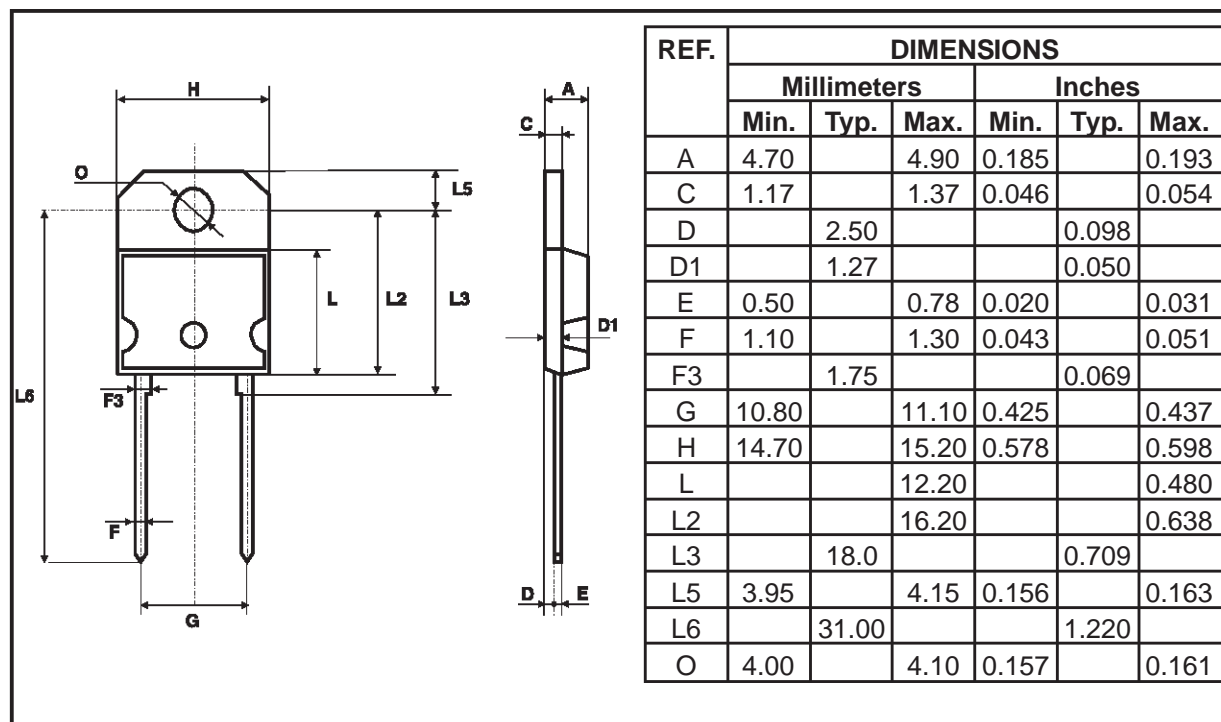

Figure 12. Turn-off switching characteristics (with series inductance)



**PACKAGE MECHANICAL DATA :**  
SOD93 Plastic



- **Marking:** type number
- **Cooling method:** by conduction (method C)
- **Weight:** 3.79g
- **Recommended torque value:** 80cm. N
- **Maximum torque value:** 100cm. N

Information furnished is believed to be accurate and reliable. However, STMicroelectronics assumes no responsibility for the consequences of use of such information nor for any infringement of patents or other rights of third parties which may result from its use. No license is granted by implication or otherwise under any patent or patent rights of STMicroelectronics. Specifications mentioned in this publication are subject to change without notice. This publication supersedes and replaces all information previously supplied. STMicroelectronics products are not authorized for use as critical components in life support devices or systems without express written approval of STMicroelectronics.

The ST logo is a registered trademark of STMicroelectronics  
© 1999 STMicroelectronics - Printed in Italy - All rights reserved.

STMicroelectronics GROUP OF COMPANIES  
Australia - Brazil - China - Finland - France - Germany - Hong Kong - India - Italy - Japan - Malaysia  
Malta - Morocco - Singapore - Spain - Sweden - Switzerland - United Kingdom - U.S.A.

<http://www.st.com>