

### General Description

The AAT7103 25V N-Channel Power MOSFET is a member of AnalogicTech™'s TrenchDMOS™ product family. Using the ultra-high density proprietary TrenchDMOS technology, the product demonstrates high power handling and small size.

### Features

- $V_{DS(MAX)} = 25V$
- $I_{D(MAX)}^{(1)} = 6.8 A @ 25^{\circ}C$
- Low  $R_{DS(ON)}$ :
  - $26 m\Omega @ V_{GS} = 4.5V$
  - $41 m\Omega @ V_{GS} = 2.5V$

### Applications

- Battery Packs
- Cellular & Cordless Telephones
- PDAs, Camcorders, and Cell Phones

### Dual SOP-8 Package

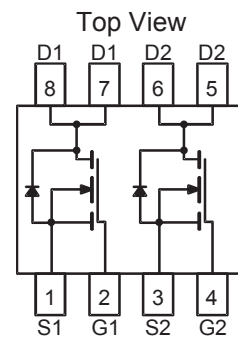

www.DataSheet4U.com

### Absolute Maximum Ratings ( $T_A=25^{\circ}C$ unless otherwise noted)

Symbol	Description	Value	Units
$V_{DS}$	Drain-Source Voltage	25	V
$V_{GS}$	Gate-Source Voltage	$\pm 12$	
$I_D$	Continuous Drain Current @ $T_J=150^{\circ}C$ <sup>1</sup>	$T_A = 25^{\circ}C$	$\pm 6.8$
		$T_A = 70^{\circ}C$	$\pm 5.4$
$I_{DM}$	Pulsed Drain Current <sup>3</sup>	$\pm 24$	A
$I_S$	Continuous Source Current (Source-Drain Diode) <sup>1</sup>	1.8	
$P_D$	Maximum Power Dissipation <sup>1</sup>	$T_A = 25^{\circ}C$	2.0
		$T_A = 70^{\circ}C$	1.25
$T_J, T_{STG}$	Operating Junction and Storage Temperature Range	-55 to 150	$^{\circ}C$

### Thermal Characteristics

Symbol	Description	Value	Units
$R_{\theta JA}$	Typical Junction-to-Ambient steady state, one FET on <sup>2</sup>	100	$^{\circ}C/W$
$R_{\theta JA2}$	Maximum Junction-to-Ambient Figure, $t < 10$ sec. <sup>1</sup>	62.5	$^{\circ}C/W$
$R_{\theta JF}$	Typical Junction-to-Foot, one FET on <sup>1</sup>	35	$^{\circ}C/W$

### Electrical Characteristics (T<sub>J</sub>=25°C unless otherwise noted)

Symbol	Description	Conditions	Min	Typ	Max	Units
<b>DC Characteristics</b>						
BV <sub>DSS</sub>	Drain-Source Breakdown Voltage	V <sub>GS</sub> =0V, I <sub>D</sub> =250μA	25			V
R <sub>DS(ON)</sub>	Drain-Source ON-Resistance <sup>3</sup>	V <sub>GS</sub> =4.5V, I <sub>D</sub> =6.8A		19	26	mΩ
		V <sub>GS</sub> =2.5V, I <sub>D</sub> =5.4A		28	41	
I <sub>D(ON)</sub>	On-State Drain Current <sup>3</sup>	V <sub>GS</sub> =4.5V, V <sub>DS</sub> =5V (Pulsed)	24			A
V <sub>GS(th)</sub>	Gate Threshold Voltage	V <sub>GS</sub> =V <sub>DS</sub> , I <sub>D</sub> =250μA	0.6			V
I <sub>GSS</sub>	Gate-Body Leakage Current	V <sub>GS</sub> = ±12V, V <sub>DS</sub> =0V			±100	nA
I <sub>DSS</sub>	Drain Source Leakage Current	V <sub>GS</sub> =0V, V <sub>DS</sub> =25V			1	μA
		V <sub>GS</sub> =0V, V <sub>DS</sub> =20V, T <sub>J</sub> =70°C			5	
g <sub>fs</sub>	Forward Transconductance <sup>3</sup>	V <sub>DS</sub> =5V, I <sub>D</sub> =6.8A		20		S
<b>Dynamic Characteristics <sup>4</sup></b>						
Q <sub>G</sub>	Total Gate Charge	V <sub>DS</sub> =15V, R <sub>D</sub> =2.2Ω, V <sub>GS</sub> =4.5V		13	19	nC
Q <sub>GS</sub>	Gate-Source Charge	V <sub>DS</sub> =15V, R <sub>D</sub> =2.2Ω, V <sub>GS</sub> =4.5V		1.9		
Q <sub>GD</sub>	Gate-Drain Charge	V <sub>DS</sub> =15V, R <sub>D</sub> =2.2Ω, V <sub>GS</sub> =4.5V		2.9		
t <sub>D(ON)</sub>	Turn-ON Delay	V <sub>DD</sub> =15V, V <sub>GS</sub> =10V, R <sub>D</sub> =2.2Ω, RG=6Ω		15		ns
t <sub>R</sub>	Turn-ON Rise Time	V <sub>DD</sub> =15V, V <sub>GS</sub> =10V, R <sub>D</sub> =2.2Ω, RG=6Ω		18		
t <sub>D(OFF)</sub>	Turn-OFF Delay	V <sub>DD</sub> =15V, V <sub>GS</sub> =10V, R <sub>D</sub> =2.2Ω, RG=6Ω		36		
t <sub>F</sub>	Turn-OFF Fall Time	V <sub>DD</sub> =15V, V <sub>GS</sub> =10V, R <sub>D</sub> =2.2Ω, RG=6Ω		27		
<b>Source-Drain Diode Characteristics</b>						
V <sub>SD</sub>	Source-Drain Forward Voltage <sup>3</sup>	V <sub>GS</sub> =0, I <sub>S</sub> =6.8A			1.5	V
I <sub>S</sub>	Continuous Diode Current <sup>1</sup>				1.8	A

Note 1: Based on thermal dissipation from junction to ambient while mounted on a 1" x 1" PCB with optimized layout. A 10 second pulse on a 1" x 1" PCB approximates testing a device mounted on a large multi-layer PCB as in many applications. R<sub>θJF</sub> + R<sub>θFA</sub> = R<sub>θJA</sub> where the foot thermal reference is defined as the normal solder mounting surface of the device's leads. R<sub>θJF</sub> is guaranteed by design; however, R<sub>θFA</sub> is determined by PCB design. Actual maximum continuous current is limited by the application's design.

Note 2: Steady state thermal response while mounted on a 1" x 1" PCB with maximum copper area is provided for comparison with other devices. This test condition approximates many battery pack applications.

Note 3: Pulsed measurement 300 μs, single pulse.

Note 4: Guaranteed by design. Not subject to production testing.

### Typical Characteristics

( $T_J = 25^\circ\text{C}$  unless otherwise noted)

#### Output Characteristics

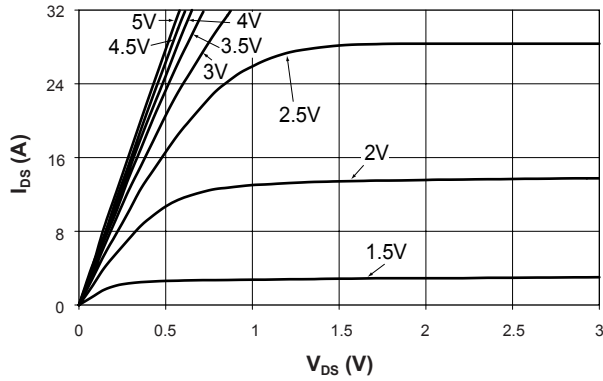

#### Transfer Characteristics

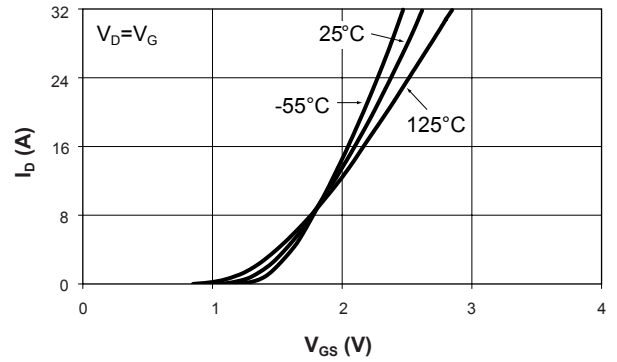

#### On-Resistance vs. Drain Current

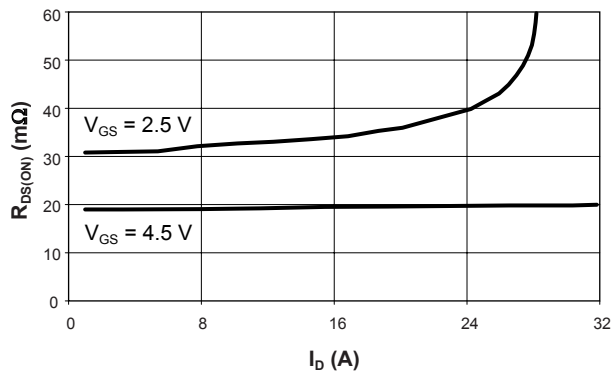

#### On-Resistance vs. Gate to Source Voltage

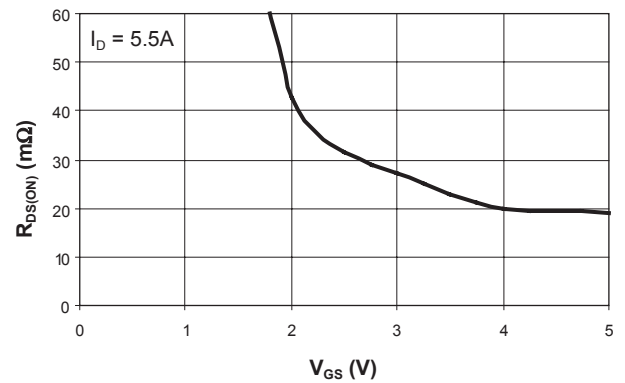

#### Gate Charge

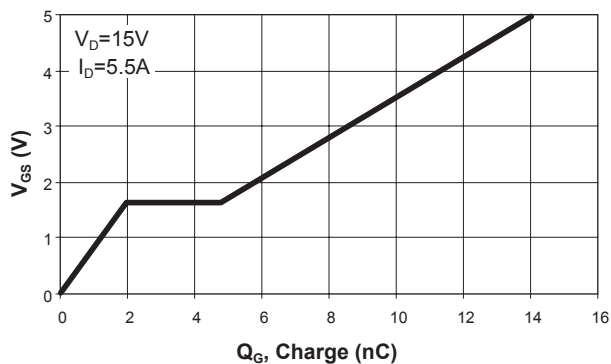

#### Source-Drain Diode Forward Voltage

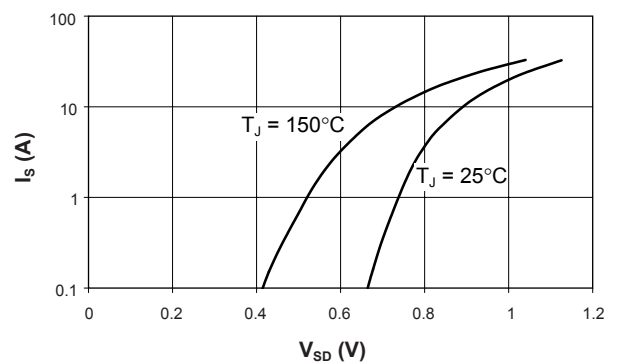

## Ordering Information

Package	Marking	Part Number (Tape and Reel)
SOP-8	7103	<b>AAT7103IAS-T1</b>

Note: Sample stock is generally held on all part numbers listed in **BOLD**.

## Package Information

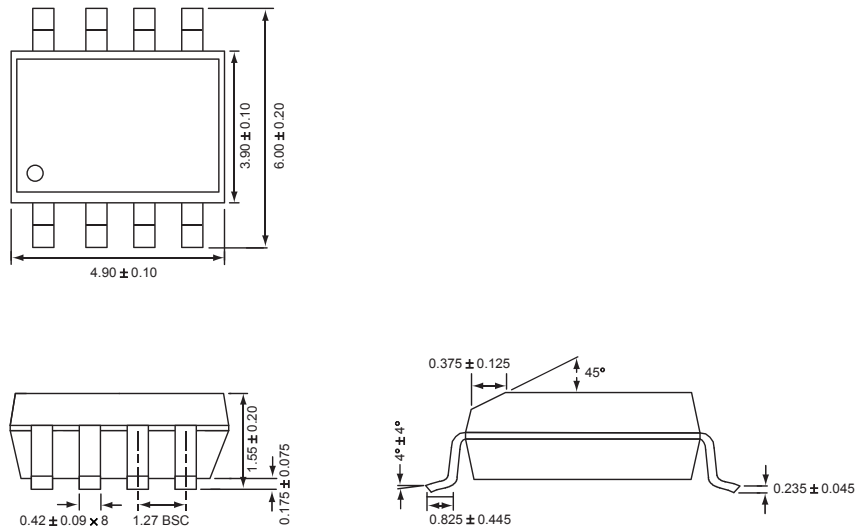

All dimensions in millimeters.

AnalogicTech cannot assume responsibility for use of any circuitry other than circuitry entirely embodied in an AnalogicTech product. No circuit patent licenses, copyrights, mask work rights, or other intellectual property rights are implied.

AnalogicTech reserves the right to make changes to their products or specifications or to discontinue any product or service without notice, and advise customers to obtain the latest version of relevant information to verify, before placing orders, that information being relied on is current and complete. All products are sold subject to the terms and conditions of sale supplied at the time of order acknowledgement, including those pertaining to warranty, patent infringement, and limitation of liability.

AnalogicTech warrants performance of its semiconductor products to the specifications applicable at the time of sale in accordance with AnalogicTech's standard warranty. Testing and other quality control techniques are utilized to the extent AnalogicTech deems necessary to support this warranty. Specific testing of all parameters of each device is not necessarily performed.

**Advanced Analogic Technologies, Inc.**  
 830 E. Arques Avenue, Sunnyvale, CA 94085  
 Phone (408) 737-4600  
 Fax (408) 737-4611