

# BIPOLAR ANALOG INTEGRATED CIRCUITS

# $\mu$ PC2791TB, $\mu$ PC2792TB

### 5 V, SUPER MINIMOLD SILICON MMIC VHF-UHF WIDEBAND AMPLIFIER

#### DESCRIPTION

The  $\mu$ PC2791TB and  $\mu$ PC2792TB are silicon monolithic integrated circuits designed as 2nd IF buffer amplifier for DBS tuners. These ICs are packaged in super minimold package which is smaller than conventional minimold. So, in the case of reducing your system size,  $\mu$ PC2791TB and  $\mu$ PC2792TB are suitable. Among the 6-pin mini/super-minimold amplifiers,  $\mu$ PC2791TB and  $\mu$ PC2792TB have unique pin locations taken over from conventional 4-pin minimold  $\mu$ PC1675G,  $\mu$ PC1676G and  $\mu$ PC1688G.

These ICs are manufactured using NEC's 10GHz fr NESAT™ II AL silicon bipolar process. This process uses silicon nitride passivation film. The material can protect chip surface from external pollution and prevent corrosion/migration. Thus, these IC have excellent performance, uniformity and reliability.

#### FEATURES

- High-density surface mounting : 6-pin super minimold package (2.0 × 1.25 × 0.9 mm)
- Supply voltage :  $V_{CC} = 4.5$  to  $5.5$  V
- Wideband response :  $\mu$ PC2791TB;  $f_u = 1.9$  GHz TYP. @3 dB bandwidth  
 $\mu$ PC2792TB;  $f_u = 1.2$  GHz TYP. @3 dB bandwidth
- Power gain :  $\mu$ PC2791TB;  $G_P = 12$  dB TYP. @f = 500 MHz  
 $\mu$ PC2792TB;  $G_P = 22$  dB TYP. @f = 500 MHz

#### APPLICATION

- 400 MHz band 2nd IF buffer amplifiers in DBS tuners (2nd frequency converter block), etc.

#### ORDERING INFORMATION

Part Number	Package	Marking	Supplying Form
$\mu$ PC2791TB-E3	6-pin super minimold	C2S	Embossed tape 8 mm wide. 1, 2, 3 pins face to perforation side of the tape. Qty 3kpcs/reel.
$\mu$ PC2792TB-E3		C2T	

**Remark** To order evaluation samples, please contact your local NEC sales office. (Part number for sample order:  $\mu$ PC2791TB,  $\mu$ PC2792TB)

#### Caution Electro-static sensitive devices

The information in this document is subject to change without notice. Before using this document, please confirm that this is the latest version.  
Not all devices/types available in every country. Please check with local NEC representative for availability and additional information.

PIN CONNECTIONS

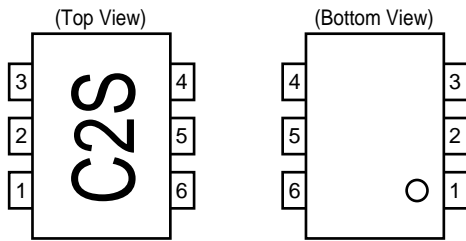

Marking is an example of μPC2791TB

Pin No.	Pin Name
1	GND
2	GND
3	OUTPUT
4	V <sub>CC</sub>
5	GND
6	INPUT

**Caution** μPC2791TB, μPC2792TB pin locations are different from the other 6-pin mini/super-minimold amplifiers.

PRODUCT LINE-UP (T<sub>A</sub> = +25°C, V<sub>CC</sub> = 5.0 V, Z<sub>S</sub> = Z<sub>L</sub> = 50 Ω)

Part Number	f <sub>u</sub> (GHz)	P <sub>o(sat)</sub> (dBm)	G <sub>P</sub> (dB)	NF (dB)	I <sub>cc</sub> (mA)	Package	Marking
μPC1675G	1.9	+4.0	12	5.5	17	4-pin minimold	C1A
μPC2791TB						6-pin super minimold	C2S
μPC1688G	1.1	+4.0	21	4.0	19	4-pin minimold	C1C
μPC1676G	1.2	+5.0	22	4.5	19	4-pin minimold	C1B
μPC2792TB			20	3.5		6-pin super minimold	C2T

**Remarks** Typical performance. Please refer to ELECTRICAL CHARACTERISTICS in detail.

**Caution** This document is to specified for μPC2791TB and μPC2792TB. For the other part numbers mentioned in this document, the data sheet of each part number should be referred.

SYSTEM APPLICATION EXAMPLE

Example of DBS tuners (2nd frequency converter block)

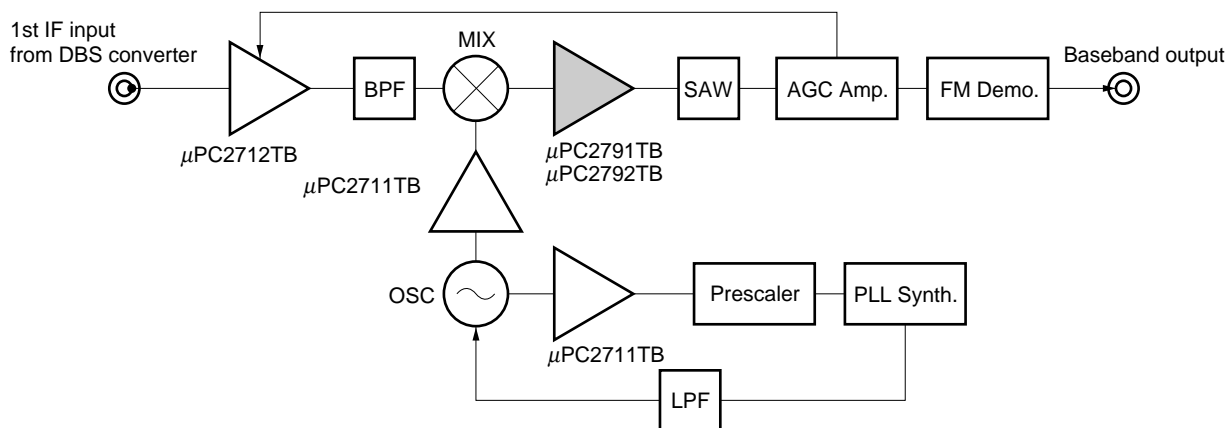

PIN EXPLANATION

Pin No.	Pin Name	Applied Voltage (V)	Pin Voltage (V) <sup>Note</sup>	Function and Applications	Internal Equivalent Circuit
1 2 5	GND	0	—	Ground pin. This pin should be connected to system ground with minimum inductance. Ground pattern on the board should be formed as wide as possible. All the ground pins must be connected together with wide ground pattern to decrease impedance difference.	<p><b>μPC2791TB</b></p>
3	OUTPUT	—	3.92 ----- 3.96	Signal output pin. A internal matching circuit, configured with resistors, enables 50 Ω connection over a wide band. This pin must be coupled to next stage with capacitor for DC cut.	
4	Vcc	4.5 to 5.5	—	Power supply pin. This pin should be externally equipped with bypass capacity to minimize ground impedance.	<p><b>μPC2792TB</b></p>
6	INPUT	—	1.11 ----- 0.92	Signal input pin. A internal matching circuit, configured with resistors, enables 50 Ω connection over a wide band. A multi-feedback circuit is designed to cancel the deviations of h <sub>FE</sub> and resistance. This pin must be coupled to front stage with capacitor for DC cut.	

**Note** Pin voltage is measured at V<sub>cc</sub> = 5.0 V. Above: μPC2791TB, Below: μPC2792TB

**ABSOLUTE MAXIMUM RATINGS**

Parameter	Symbol	Conditions	Ratings	Unit
Supply Voltage	$V_{CC}$	$T_A = +25^\circ\text{C}$	6	V
Power Dissipation	$P_D$	Mounted on doublesided copper clad 50 × 50 × 1.6 mm epoxy glass PWB ( $T_A = +85^\circ\text{C}$ )	200	mW
Operating Ambient Temperature	$T_A$		-40 to +85	$^\circ\text{C}$
Storage Temperature	$T_{stg}$		-55 to +150	$^\circ\text{C}$
Input Power	$P_{in}$	$T_A = +25^\circ\text{C}$	+10	dBm

**RECOMMENDED OPERATING CONDITIONS**

Parameter	Symbol	MIN.	TYP.	MAX.	Unit
Supply Voltage	$V_{CC}$	4.5	5.0	5.5	V
Operating Ambient Temperature	$T_A$	-40	+25	+85	$^\circ\text{C}$

**ELECTRICAL CHARACTERISTICS ( $T_A = +25^\circ\text{C}$ ,  $V_{CC} = 5.0\text{ V}$ ,  $Z_s = Z_L = 50\Omega$ )**

Parameter	Symbol	Test Conditions	$\mu$ PC2791TB			$\mu$ PC2792TB			Unit
			MIN.	TYP.	MAX.	MIN.	TYP.	MAX.	
Circuit Current	$I_{CC}$	No signal	12	17	22	14	19	24	mA
Power Gain	$G_P$	$f = 500\text{ MHz}$	10	12	14	17	20	22	dB
Noise Figure	NF	$f = 500\text{ MHz}$	—	5.5	7.0	—	3.5	6.0	dB
Upper Limit Operating Frequency	$f_u$	3 dB down from flat gain	1.6	1.9	—	1.0	1.2	—	GHz
Isolation	ISL	$f = 500\text{ MHz}$	20	24	—	24	28	—	dB
Input Return Loss	$RL_{in}$	$f = 500\text{ MHz}$	9	12	—	12	15	—	dB
Output Return Loss	$RL_{out}$	$f = 500\text{ MHz}$	8	11	—	9	12	—	dB
Saturated Output Power	$P_{O(sat)}$	$f = 500\text{ MHz}$ , $P_{in} = 0\text{ dBm}$	+2.0	+4.0	—	+3.0	+5.0	—	dBm

TEST CIRCUIT

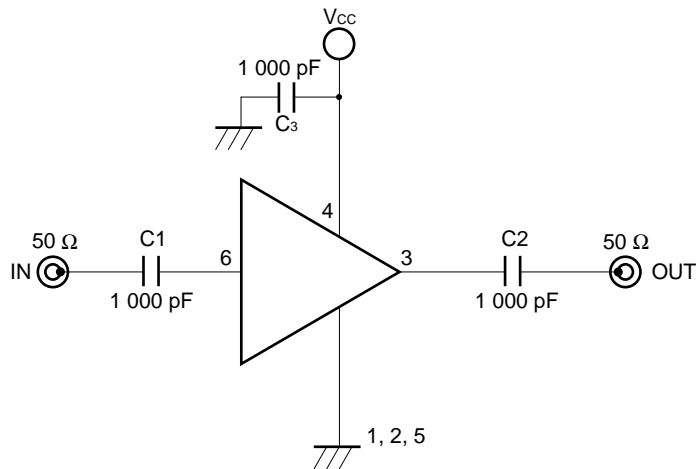

EXAMPLE OF APPLICATION CIRCUIT

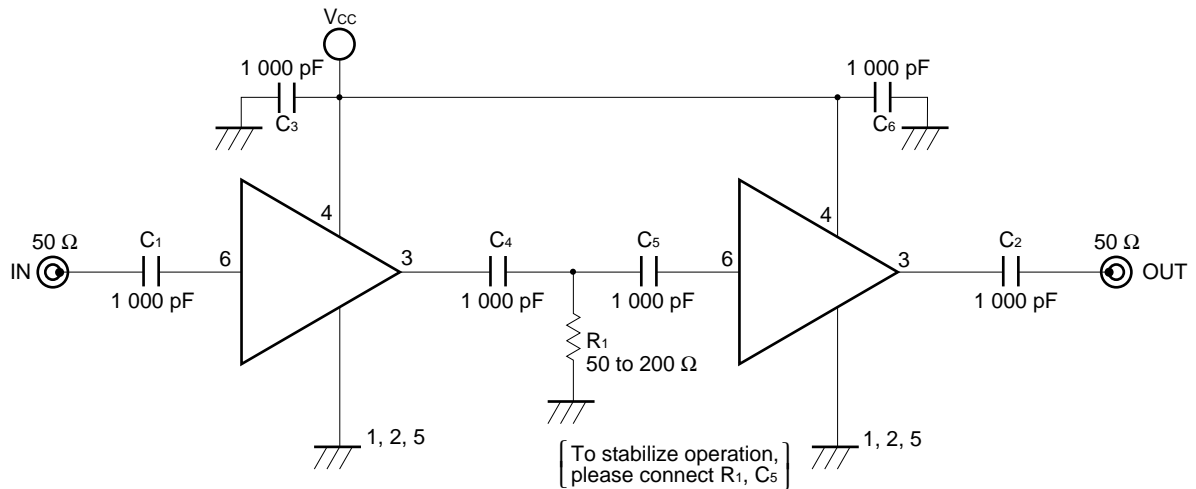

The application circuits and their parameters are for reference only and are not intended for use in actual design-ins.

CAPACITORS FOR THE V<sub>cc</sub>, INPUT AND OUTPUT PINS

1 000 pF capacitors are recommendable as bypass capacitor for V<sub>cc</sub> pin and coupling capacitors for input/output pins.

Bypass capacitor for V<sub>cc</sub> pin is intended to minimize V<sub>cc</sub> pin's ground impedance. Therefore, stable bias can be supplied against V<sub>cc</sub> fluctuation.

Coupling capacitors for input/output pins are intended to minimize RF serial impedance and cut DC.

To get flat gain from 100 MHz up, 1 000 pF capacitors are assembled on the test circuit. [Actually, 1 000 pF capacitors give flat gain at least 10 MHz. In the case of under 10 MHz operation, increase the value of coupling capacitor such as 2 200 pF. Because the coupling capacitors are determined by the equation of  $C = 1/(2 \pi fZ_s)$ .]

ILLUSTRATION OF THE TEST CIRCUIT ASSEMBLED ON EVALUATION BOARD

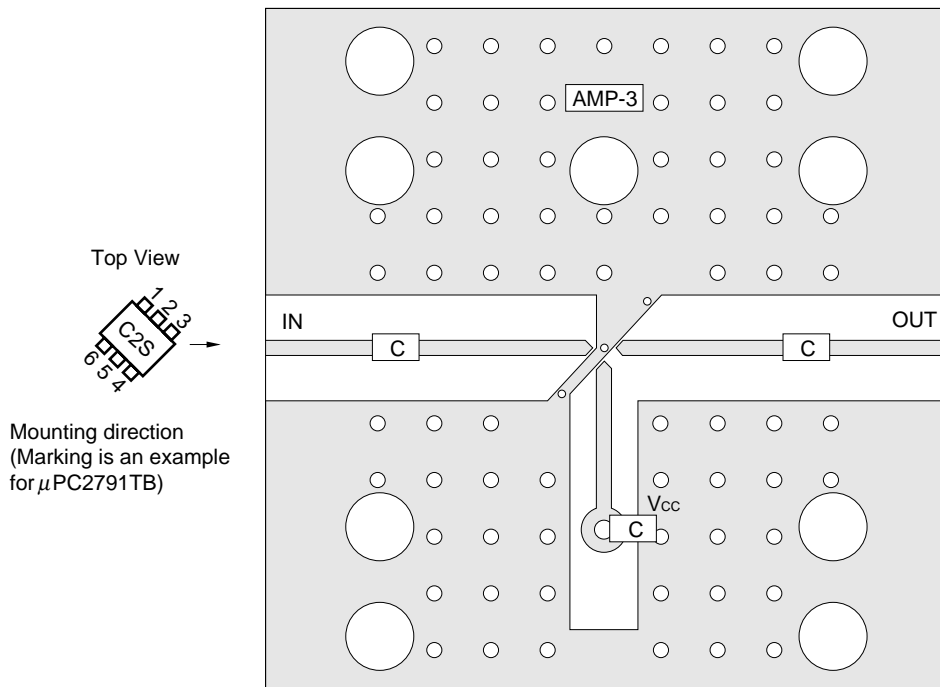

COMPONENT LIST

	Value
C	1 000 pF

Notes

1. 30 × 30 × 0.4 mm double sided copper clad polyimide board.
2. Back side : GND pattern
3. Solder plated on pattern
4. ○ ○ : Through holes

For more information on the use of this IC, refer to the following application note: USAGE AND APPLICATIONS OF 6-PIN MINI-MOLD, 6-PIN SUPER MINI-MOLD SILICON HIGH-FREQUENCY WIDEBAND AMPLIFIER MMIC (P11976E).

★ TYPICAL CHARACTERISTICS (Unless otherwise specified,  $T_A = +25^\circ\text{C}$ )

–  $\mu$ PC2791TB –

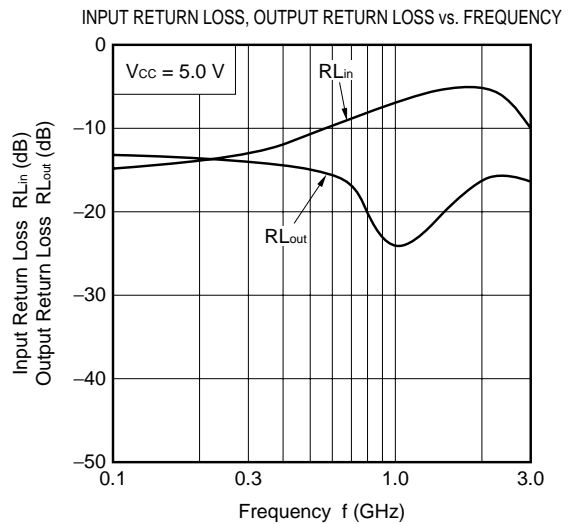
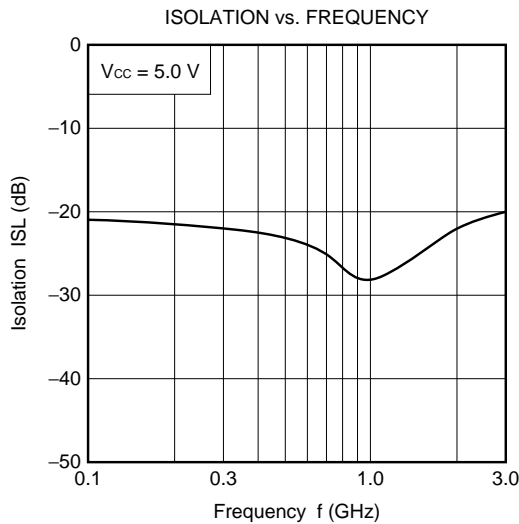
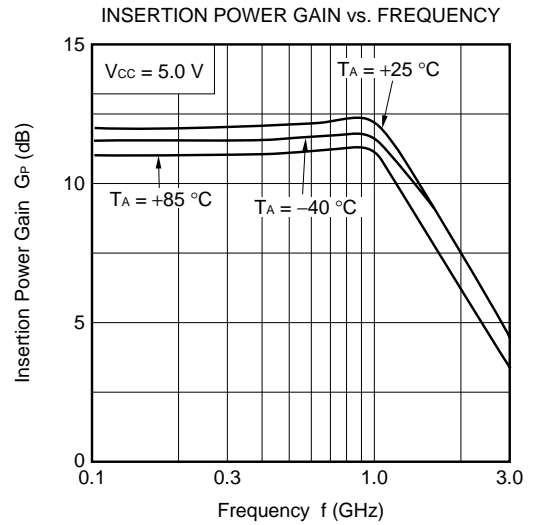
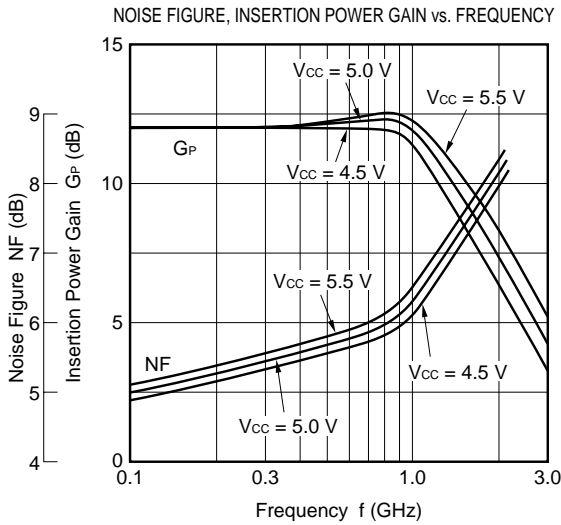
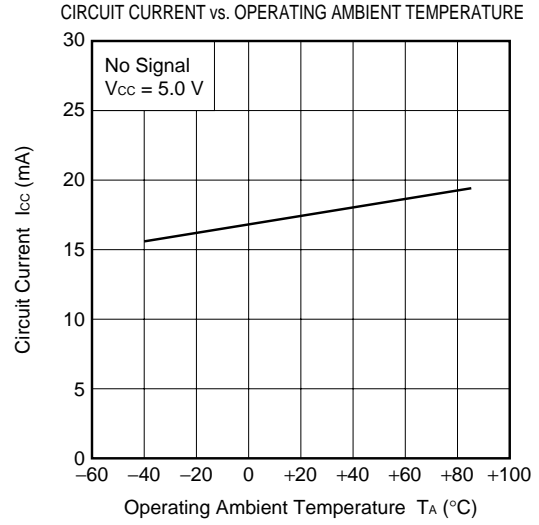
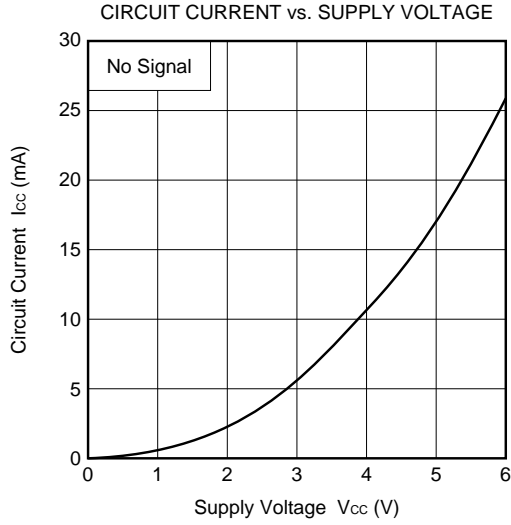

-  $\mu$ PC2791TB -

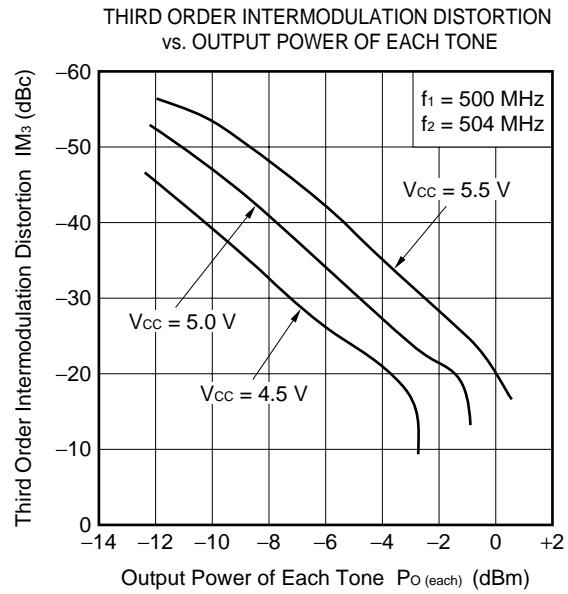
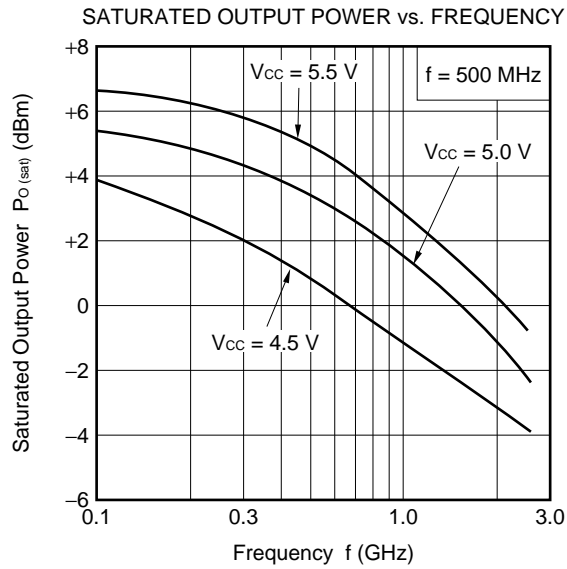
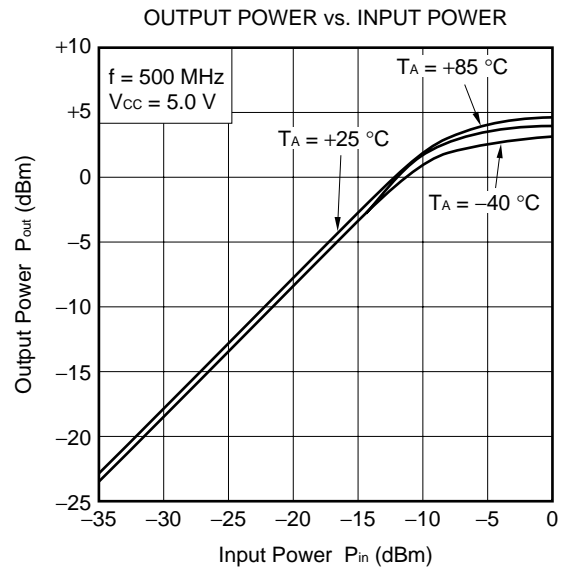
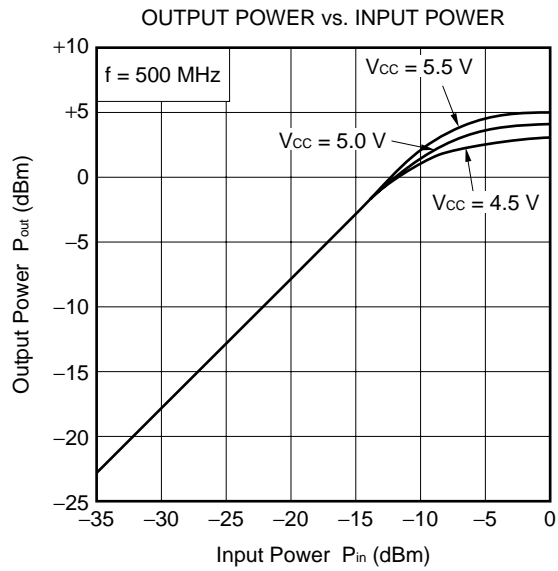



★ S-PARAMETER ( $T_A = +25^\circ\text{C}$ ,  $V_{CC} = 5.0\text{ V}$ )

–  $\mu$ PC2791TB –

S<sub>11</sub>-FREQUENCY

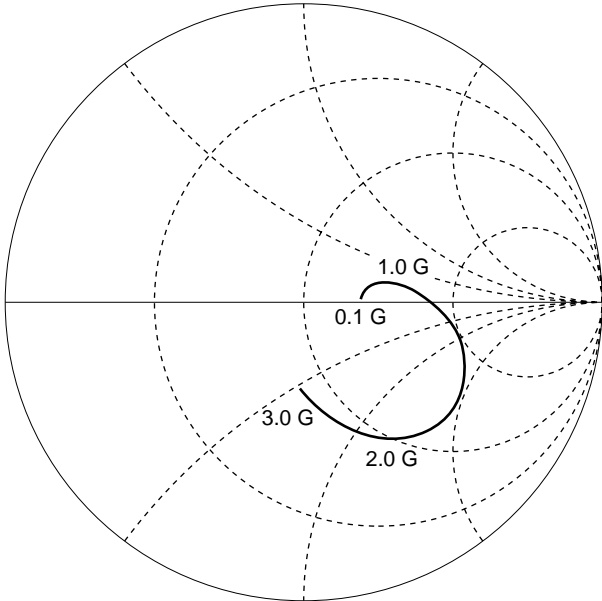

S<sub>22</sub>-FREQUENCY

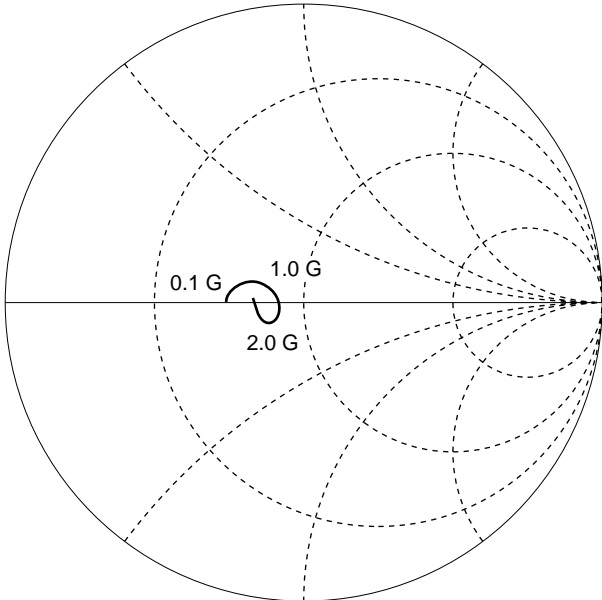

★ TYPICAL S-PARAMETER VALUES (T<sub>A</sub> = +25°C)

– μPC2791TB –

V<sub>CC</sub> = 5.0 V, I<sub>CC</sub> = 17.0 mA

FREQUENCY MHz	S <sub>11</sub>		S <sub>21</sub>		S <sub>12</sub>		S <sub>22</sub>		K
	MAG.	ANG.	MAG.	ANG.	MAG.	ANG.	MAG.	ANG.	
100.0000	0.155	11.8	4.157	-8.1	0.085	-4.4	0.211	174.9	1.53
200.0000	0.191	21.7	4.179	-16.4	0.081	-7.2	0.203	168.6	1.56
300.0000	0.240	25.3	4.193	-24.6	0.079	-11.0	0.192	163.1	1.56
400.0000	0.290	25.6	4.245	-33.2	0.075	-11.1	0.179	156.8	1.59
500.0000	0.337	22.9	4.288	-42.4	0.068	-13.2	0.161	152.3	1.65
600.0000	0.383	18.1	4.320	-51.7	0.064	-13.3	0.140	149.8	1.69
700.0000	0.418	11.0	4.316	-61.9	0.059	-13.2	0.115	149.8	1.74
800.0000	0.459	3.2	4.316	-72.0	0.054	-11.4	0.087	156.4	1.81
900.0000	0.499	-4.9	4.268	-82.3	0.049	-8.3	0.067	175.9	1.90
1000.0000	0.553	-12.7	4.243	-91.9	0.045	-1.1	0.069	-155.3	1.88
1100.0000	0.604	-19.5	4.218	-102.2	0.045	4.7	0.097	-138.9	1.72
1200.0000	0.647	-26.4	4.140	-113.2	0.041	13.4	0.133	-137.3	1.71
1300.0000	0.670	-33.9	3.981	-124.8	0.045	20.2	0.175	-140.2	1.53
1400.0000	0.672	-42.4	3.753	-136.1	0.049	27.7	0.214	-145.4	1.50
1500.0000	0.665	-50.1	3.473	-146.3	0.054	28.4	0.251	-152.7	1.47
1600.0000	0.659	-57.4	3.169	-155.5	0.058	33.3	0.279	-159.6	1.53
1700.0000	0.653	-65.1	2.924	-164.3	0.063	32.8	0.302	-166.3	1.55
1800.0000	0.645	-71.8	2.680	-172.6	0.067	33.0	0.320	-172.9	1.60
1900.0000	0.642	-77.8	2.490	-179.7	0.071	31.2	0.328	-178.8	1.63
2000.0000	0.621	-83.3	2.302	173.0	0.071	31.0	0.336	175.6	1.84
2100.0000	0.605	-89.3	2.137	166.6	0.072	30.6	0.340	170.4	1.98
2200.0000	0.577	-94.9	1.977	160.2	0.074	30.3	0.344	165.3	2.19
2300.0000	0.561	-101.0	1.838	154.2	0.076	31.4	0.343	161.7	2.35
2400.0000	0.536	-106.7	1.714	148.2	0.075	30.8	0.345	158.1	2.62
2500.0000	0.521	-111.7	1.596	142.9	0.078	31.2	0.343	154.9	2.77
2600.0000	0.509	-116.1	1.499	137.1	0.078	31.4	0.342	151.7	2.98
2700.0000	0.493	-120.9	1.416	132.2	0.080	32.1	0.340	149.4	3.12
2800.0000	0.482	-125.0	1.353	126.6	0.080	34.2	0.336	146.9	3.33
2900.0000	0.467	-128.6	1.283	122.6	0.082	33.8	0.341	144.6	3.45
3000.0000	0.453	-132.3	1.222	116.8	0.085	34.0	0.341	142.5	3.55
3100.0000	0.441	-137.2	1.172	113.1	0.087	34.2	0.341	140.4	3.68

★ TYPICAL CHARACTERISTICS (Unless otherwise specified,  $T_A = +25^\circ\text{C}$ )

–  $\mu$ PC2792TB –

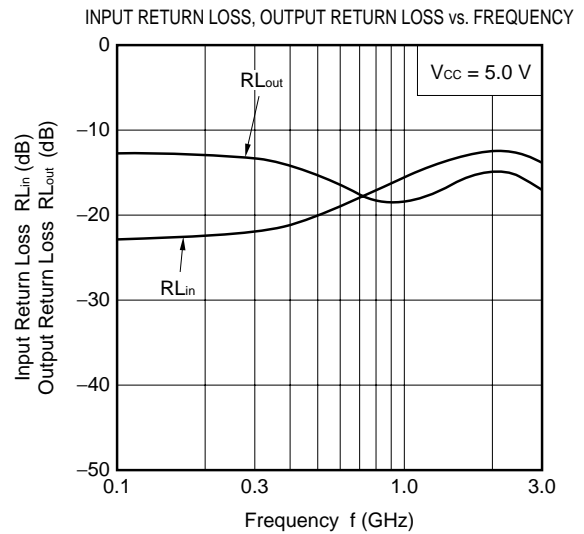
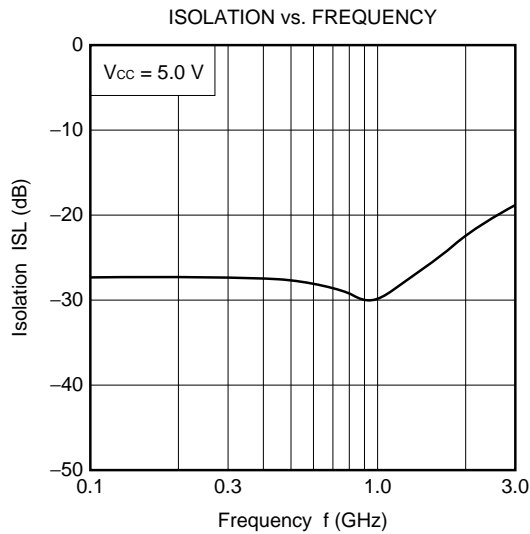
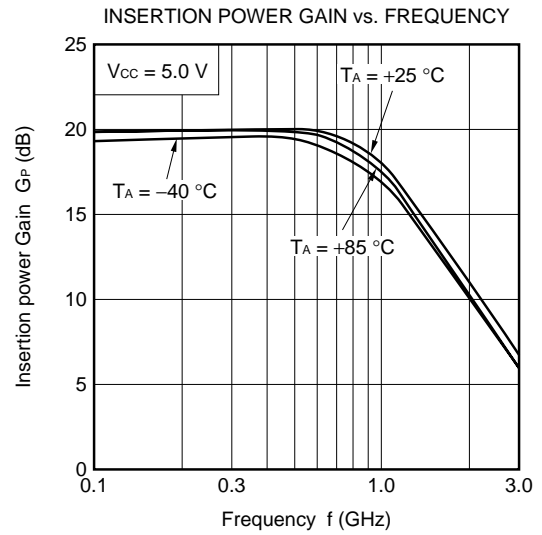
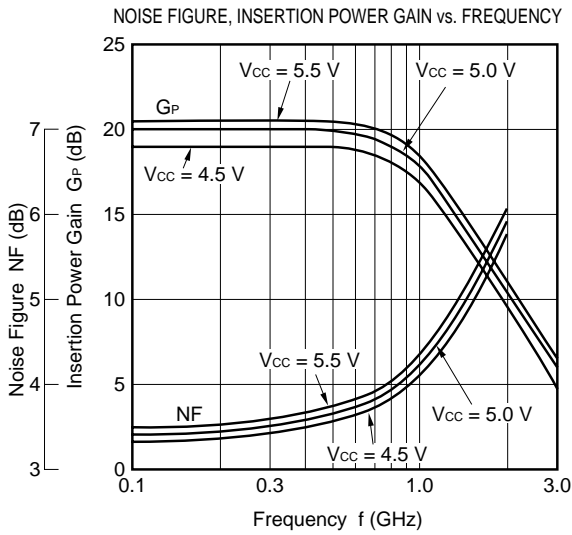
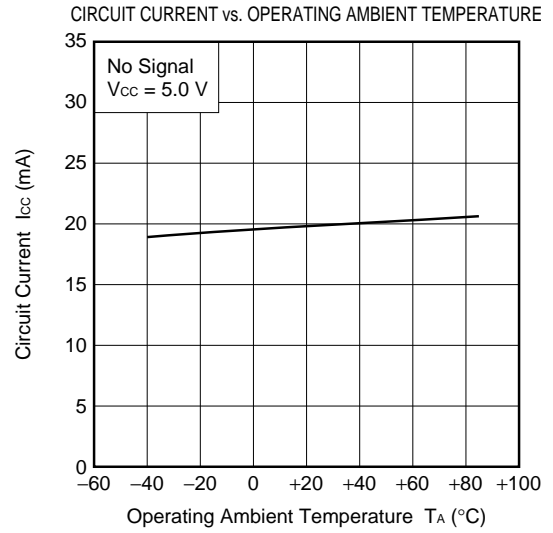
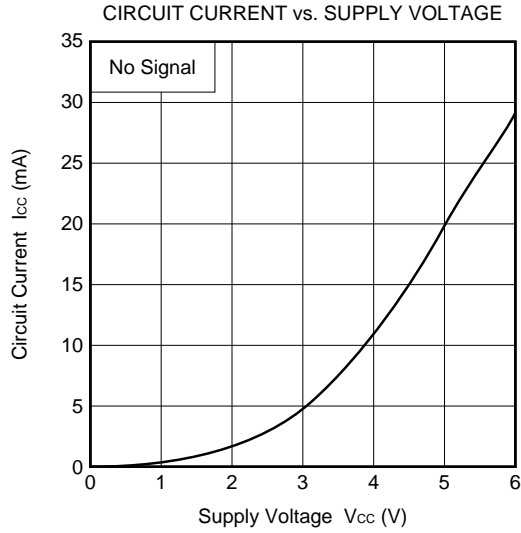

-  $\mu$ PC2792TB -

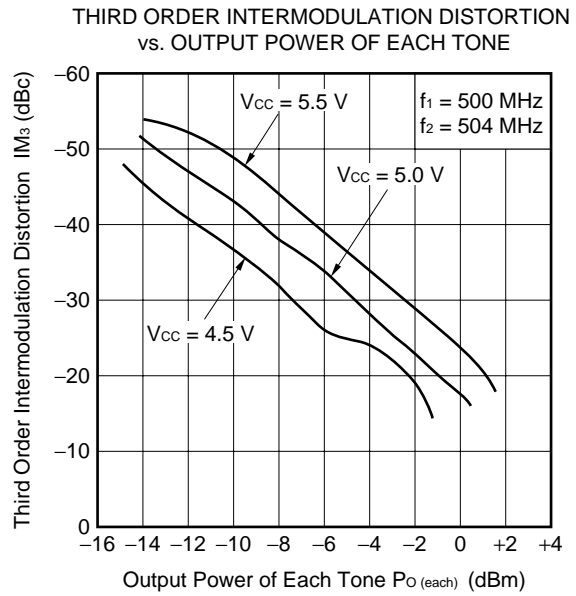
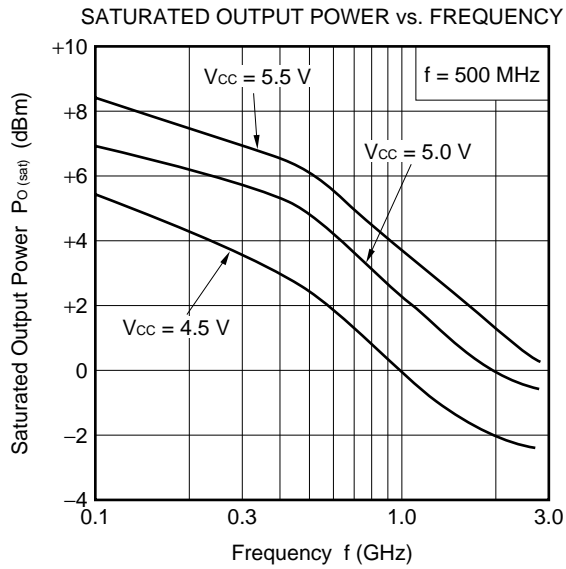
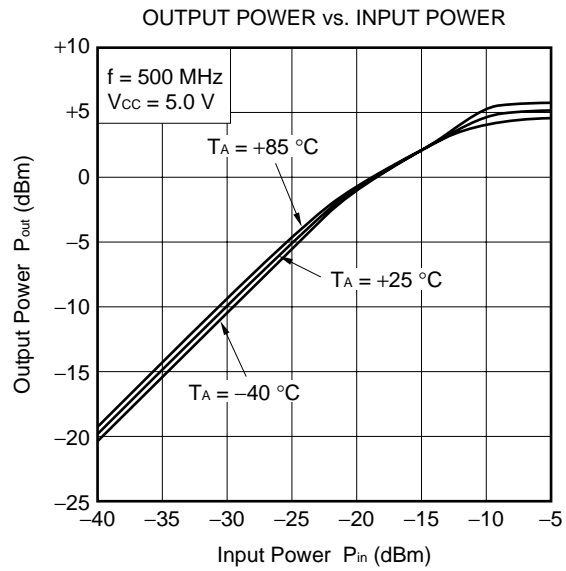
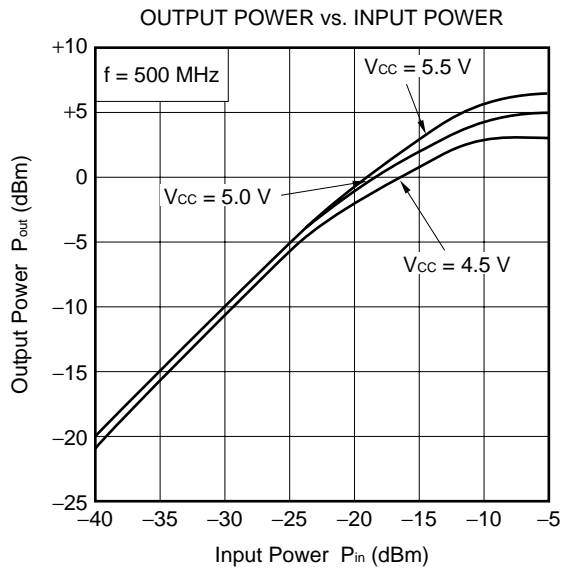

★ S-PARAMETER ( $T_A = +25^\circ\text{C}$ ,  $V_{CC} = 5.0\text{ V}$ )

–  $\mu$ PC2792TB –

S<sub>11</sub>-FREQUENCY

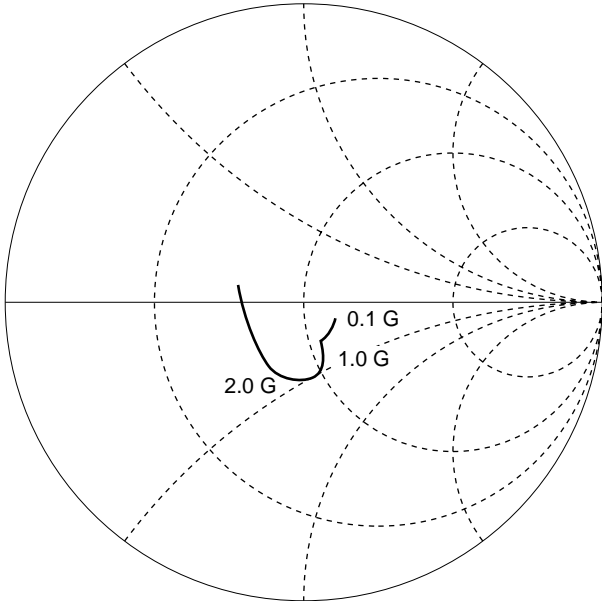

S<sub>22</sub>-FREQUENCY

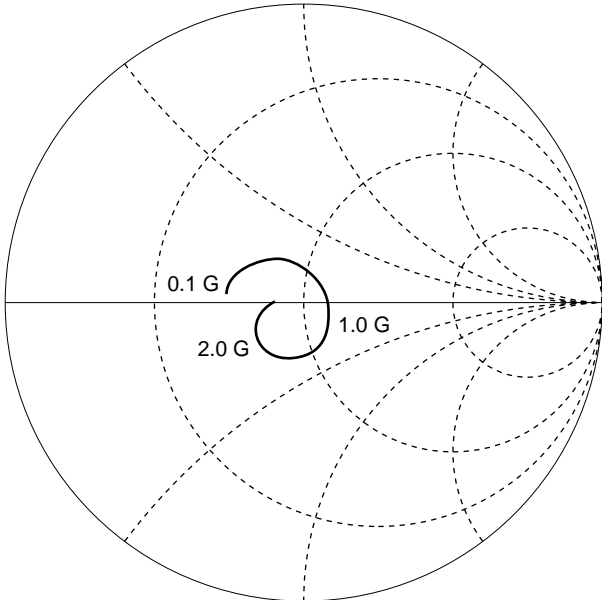

★ TYPICAL S-PARAMETER VALUES (T<sub>A</sub> = +25°C)

– μPC2792TB –

V<sub>CC</sub> = 5.0 V, I<sub>CC</sub> = 19.0 mA

FREQUENCY MHz	S <sub>11</sub>		S <sub>21</sub>		S <sub>12</sub>		S <sub>22</sub>		K
	MAG.	ANG.	MAG.	ANG.	MAG.	ANG.	MAG.	ANG.	
100.0000	0.029	-8.4	11.334	-11.1	0.038	0.4	0.205	169.7	1.34
200.0000	0.040	12.5	11.414	-22.4	0.038	1.8	0.194	157.6	1.34
300.0000	0.056	16.9	11.459	-34.1	0.036	2.7	0.180	145.4	1.37
400.0000	0.076	17.9	11.525	-46.2	0.036	3.7	0.160	130.1	1.39
500.0000	0.090	10.7	11.506	-58.9	0.035	5.3	0.137	113.0	1.42
600.0000	0.103	0.3	11.394	-72.0	0.034	8.9	0.110	91.0	1.47
700.0000	0.122	-14.9	11.159	-85.6	0.034	11.6	0.090	56.4	1.48
800.0000	0.148	-28.8	10.840	-99.5	0.034	13.9	0.094	8.9	1.50
900.0000	0.181	-40.4	10.239	-113.7	0.032	19.9	0.127	-26.9	1.58
1000.0000	0.219	-48.0	9.577	-127.1	0.031	22.9	0.174	-51.7	1.68
1100.0000	0.248	-54.0	8.783	-140.5	0.031	27.1	0.222	-71.0	1.71
1200.0000	0.271	-60.3	7.883	-153.0	0.032	32.3	0.264	-86.7	1.76
1300.0000	0.277	-67.2	6.929	-164.4	0.034	39.4	0.299	-101.0	1.87
1400.0000	0.286	-77.3	6.074	-174.3	0.035	44.0	0.322	-112.8	1.99
1500.0000	0.298	-86.0	5.338	177.3	0.038	49.1	0.341	-123.3	2.04
1600.0000	0.311	-93.2	4.709	169.7	0.040	54.9	0.350	-131.9	2.20
1700.0000	0.328	-99.6	4.206	162.6	0.046	56.5	0.358	-139.2	2.11
1800.0000	0.338	-105.2	3.793	156.0	0.048	58.3	0.360	-145.8	2.24
1900.0000	0.347	-110.0	3.474	150.4	0.053	60.5	0.356	-151.1	2.22
2000.0000	0.345	-115.4	3.179	144.6	0.055	60.4	0.355	-156.0	2.33
2100.0000	0.349	-121.1	2.926	138.7	0.059	60.3	0.350	-160.4	2.37
2200.0000	0.353	-126.8	2.704	133.6	0.063	60.5	0.346	-164.6	2.42
2300.0000	0.365	-131.5	2.513	128.2	0.069	61.7	0.339	-166.9	2.37
2400.0000	0.371	-136.3	2.345	122.8	0.072	60.7	0.335	-169.0	2.42
2500.0000	0.377	-139.3	2.192	118.0	0.077	60.6	0.329	-170.9	2.42
2600.0000	0.378	-142.3	2.059	112.6	0.082	61.3	0.324	-172.3	2.44
2700.0000	0.380	-146.4	1.931	108.2	0.083	59.9	0.316	-173.1	2.56
2800.0000	0.382	-150.0	1.827	102.7	0.091	59.9	0.314	-174.0	2.48
2900.0000	0.381	-153.4	1.727	99.0	0.094	59.4	0.317	-174.5	2.52
3000.0000	0.380	-157.0	1.633	93.7	0.098	57.4	0.318	-175.1	2.56
3100.0000	0.390	-160.4	1.557	90.1	0.102	58.2	0.318	-175.2	2.54

★ PACKAGE DIMENSIONS

6 PIN SUPER MINIMOLD (UNIT: mm)

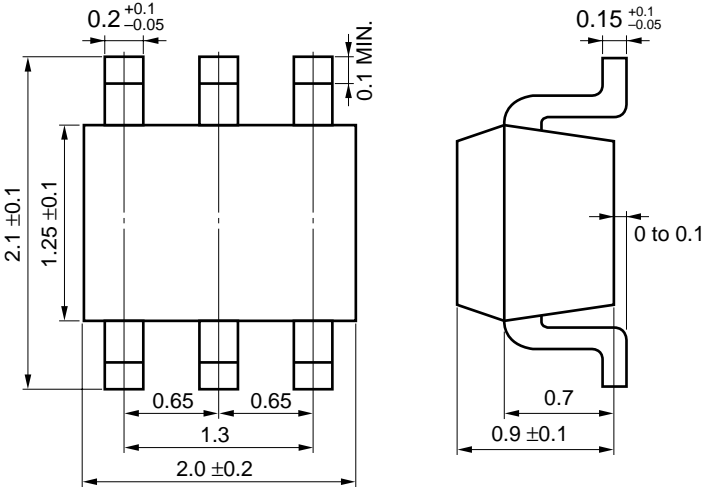

**NOTES ON CORRECT USE**

- (1) Observe precautions for handling because of electro-static sensitive devices.
- (2) Form a ground pattern as wide as possible to minimize ground impedance (to prevent undesired oscillation).  
All the ground pins must be connected together with wide ground pattern to decrease impedance difference.
- (3) The bypass capacitor should be attached to Vcc line.
- (4) The DC cut capacitor must be each attached to input and output pin.

**RECOMMENDED SOLDERING CONDITIONS**

This product should be soldered under the following recommended conditions. For soldering methods and conditions other than those recommended below, contact your NEC sales representative.

Soldering Method	Soldering Conditions	Recommended Condition Symbol
Infrared Reflow	Package peak temperature: 235°C or below Time: 30 seconds or less (at 210°C) Count: 3, Exposure limit: None <sup>Note</sup>	IR35-00-3
VPS	Package peak temperature: 215°C or below Time: 40 seconds or less (at 200°C) Count: 3, Exposure limit: None <sup>Note</sup>	VP15-00-3
Partial Heating	Pin temperature: 300°C Time: 3 seconds or less (per side of device) Exposure limit: None <sup>Note</sup>	—

**Note** After opening the dry pack, keep it in a place below 25°C and 65% RH for the allowable storage period.

**Caution Do not use different soldering methods together (except for partial heating).**

For details of recommended soldering conditions for surface mounting, refer to information document **SEMICONDUCTOR DEVICE MOUNTING TECHNOLOGY MANUAL (C10535E)**.



[MEMO]

[MEMO]

[MEMO]

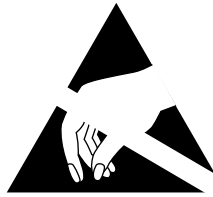

## ATTENTION

OBSERVE PRECAUTIONS  
FOR HANDLING  
ELECTROSTATIC  
SENSITIVE  
DEVICES

NESAT (NEC Silicon Advanced Technology) is a trademark of NEC Corporation.

- **The information in this document is subject to change without notice. Before using this document, please confirm that this is the latest version.**
  - No part of this document may be copied or reproduced in any form or by any means without the prior written consent of NEC Corporation. NEC Corporation assumes no responsibility for any errors which may appear in this document.
  - NEC Corporation does not assume any liability for infringement of patents, copyrights or other intellectual property rights of third parties by or arising from use of a device described herein or any other liability arising from use of such device. No license, either express, implied or otherwise, is granted under any patents, copyrights or other intellectual property rights of NEC Corporation or others.
  - Descriptions of circuits, software, and other related information in this document are provided for illustrative purposes in semiconductor product operation and application examples. The incorporation of these circuits, software, and information in the design of the customer's equipment shall be done under the full responsibility of the customer. NEC Corporation assumes no responsibility for any losses incurred by the customer or third parties arising from the use of these circuits, software, and information.
  - While NEC Corporation has been making continuous effort to enhance the reliability of its semiconductor devices, the possibility of defects cannot be eliminated entirely. To minimize risks of damage or injury to persons or property arising from a defect in an NEC semiconductor device, customers must incorporate sufficient safety measures in its design, such as redundancy, fire-containment, and anti-failure features.
  - NEC devices are classified into the following three quality grades:
    - "Standard", "Special", and "Specific". The Specific quality grade applies only to devices developed based on a customer designated "quality assurance program" for a specific application. The recommended applications of a device depend on its quality grade, as indicated below. Customers must check the quality grade of each device before using it in a particular application.
    - Standard: Computers, office equipment, communications equipment, test and measurement equipment, audio and visual equipment, home electronic appliances, machine tools, personal electronic equipment and industrial robots
    - Special: Transportation equipment (automobiles, trains, ships, etc.), traffic control systems, anti-disaster systems, anti-crime systems, safety equipment and medical equipment (not specifically designed for life support)
    - Specific: Aircraft, aerospace equipment, submersible repeaters, nuclear reactor control systems, life support systems or medical equipment for life support, etc.
- The quality grade of NEC devices is "Standard" unless otherwise specified in NEC's Data Sheets or Data Books. If customers intend to use NEC devices for applications other than those specified for Standard quality grade, they should contact an NEC sales representative in advance.