

GT19N Series

— Connectors for window-mounted antennas —

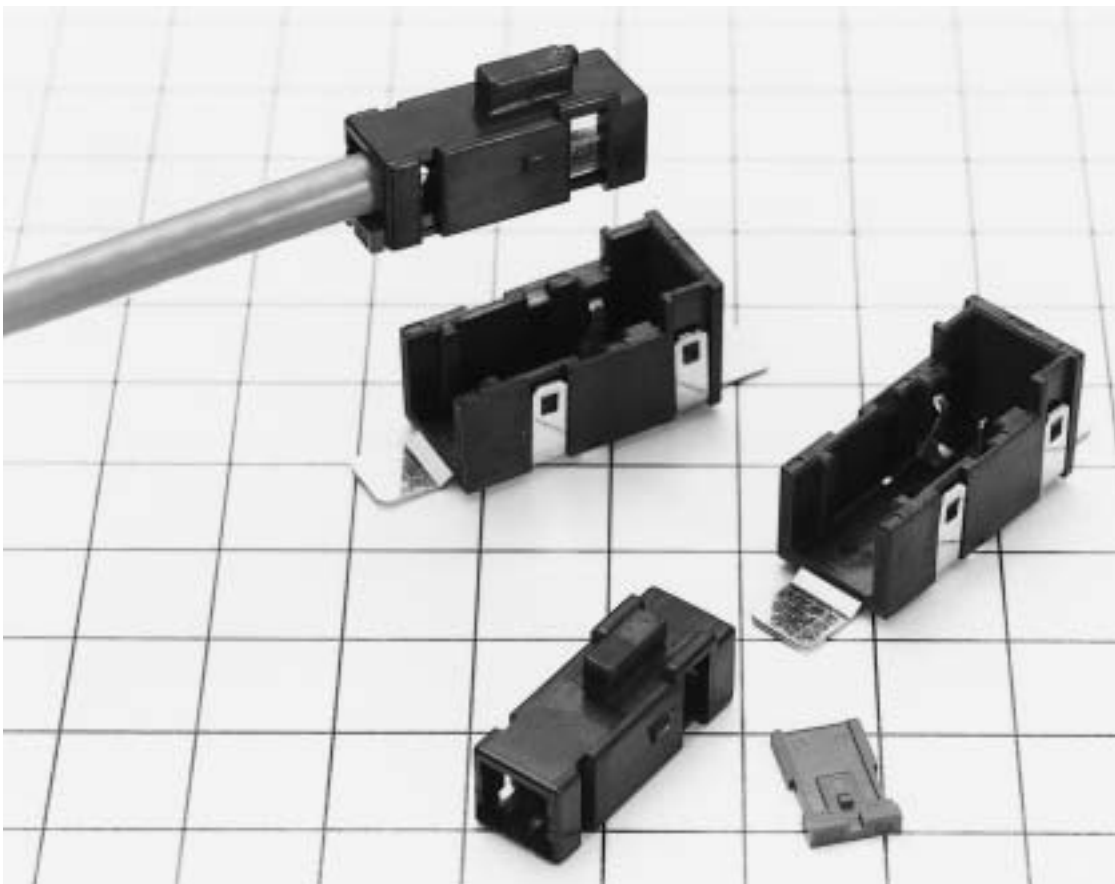

■ Features

- **Cost Performance**
Signal lines and shield can be crimped in a batch.
- **For cellular window-mounted antennas**

F Connectors

● Terminals

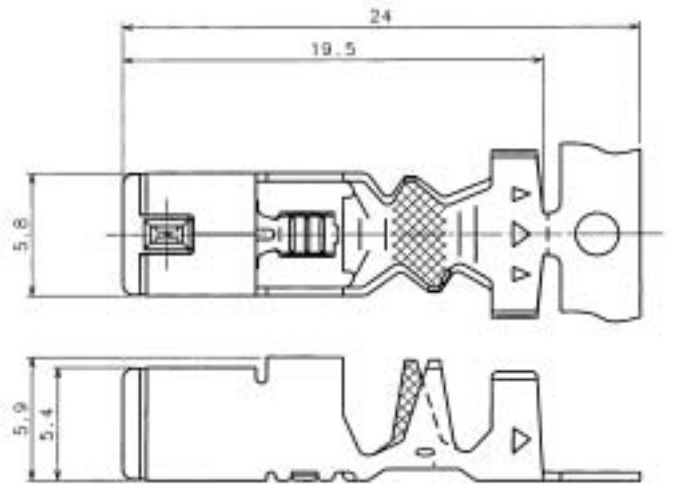

Part Number	CL No.	Wire Size (AWG)	Inner Insulation Diameter	Outer Diameter	Packaging
GT19N-2022/F3.3-5SCF	769-0001-1	#20 to 22	2.5 to 2.9 mm	4.6 to 5.0 mm	1,100 pcs. per reel
GT19N-2022/F4-5SCF	769-0009-3		3.0 to 3.6 mm		

Item	Material	Finish
Insulator	PBT	Color: Dark gray
Crimp terminals	Phosphor bronze	Tin plating
Outer terminals	Brass	Tin plating

● Housing

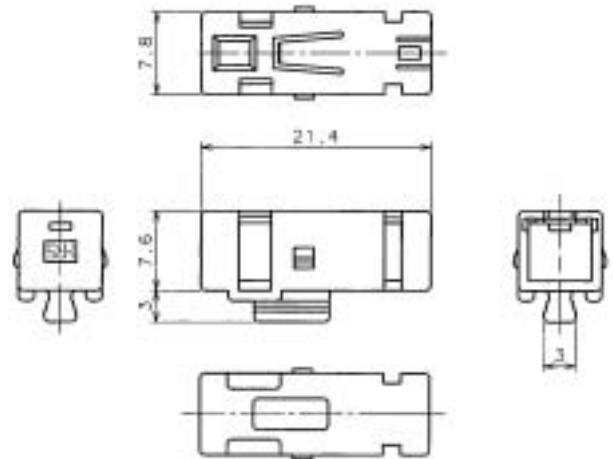

Part Number	CL No.	Material	Color
GT19N-1S-HU	769-0002-4	PBT	Light gray

● Retainer (Used with GT19N-1S-HU)

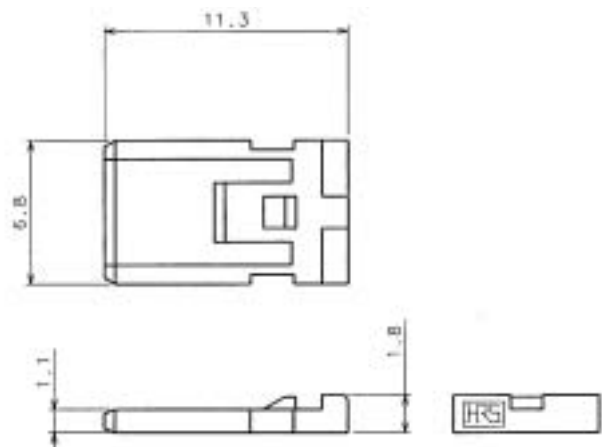

Part Number	CL No.	Material	Color
GT19N-1S-R	769-0003-7	PBT	Dark gray

■ M Connectors

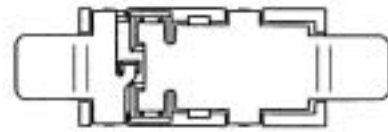
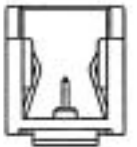
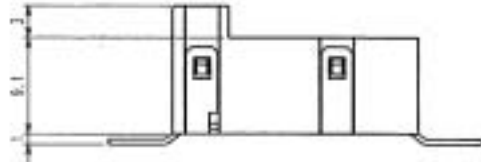
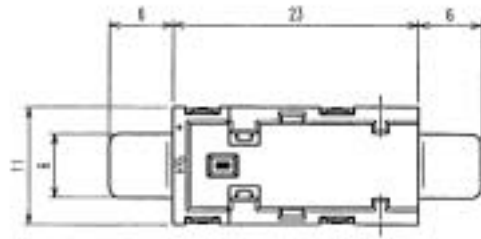
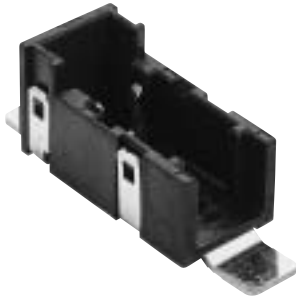

Part Number	CL No.	Material	Finish
GT19N-1P-V	769-0004-0	PPS	Color: Light gray
		Brass	Tin plating
		Copper alloy	Tin plating

◆ Fully mated connector assemblies

