

### DESCRIPTION

The HY5116810 is the new generation and fast dynamic RAM organized 2,097,152 x 8-bit. The HY5116810 utilizes Hyundai's CMOS silicon gate process technology as well as advanced circuit techniques to provide wide operating margins to the users. Multiplexed address inputs permit the HY5116810 to be packaged in standard 28/28 pin plastic SOJ, TSOP-II and Reverse TSOP-II.

The package size provides high system bit densities and is compatible with widely available automated testing and insertion equipments. System oriented feature includes single power supply of 5V±10% tolerance and direct interfacing capability with high performance logic families such as Schottky TTL.

### FEATURES

- Low power dissipation  
**Max. battery back-up 3.3mW (SL-part)**  
**Max. CMOS standby 2.2mW (SL-part)**  
**5.5mW**  
**Max. TTL standby 11.0mW**  
**Max. operating**

Speed	Power
70	715mW
80	660mW
100	605mW

- Single power supply of 5V±10%
- TTL compatible inputs and outputs
- Fast access Time

Speed	t <sub>TRAC</sub>	t <sub>CAC</sub>	t <sub>PC</sub>
70	70ns	20ns	45ns
80	80ns	20ns	50ns
100	100ns	25ns	60ns

- Fast page mode operation
- Write-Per-Bit
- Read-Modify-Write capability
- CAS-before-RAS, RAS-only, Hidden refresh and Self Refresh
- 4096 refresh cycles / 256ms (SL-part)  
 4096 refresh cycles / 64ms

### PIN DESCRIPTION

RAS	Row Address Strobe
CAS	Column Address Strobe
WB/WE	Write-Per-Bit/Write Enable
OE	Output Enable
A0-A10	Address Input
W/DQ0-DQ7	Write Mask/Data I/O
VCC	Power (+5V)
VSS	Ground

### PIN CONNECTION

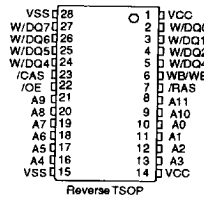
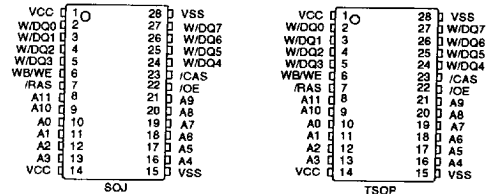

### BLOCK DIAGRAM

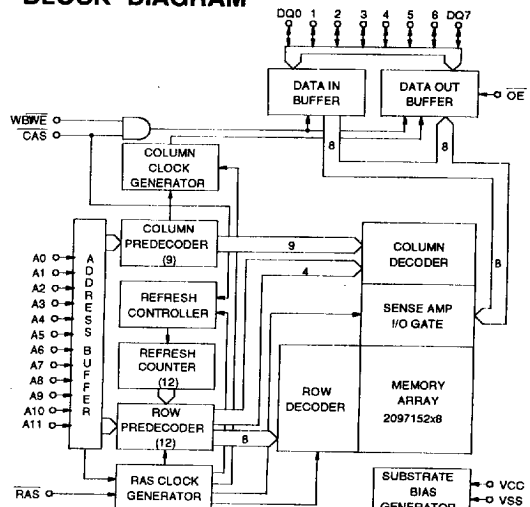

This document is a general product description and is subject to change without notice. Hyundai electronics does not assume any responsibility for use of circuits described. No patent licences are implied.  
**1AD09-10-MAY94**

**ABSOLUTE MAXIMUM RATINGS**

SYMBOL	PARAMETER	RATING	UNIT
TA	Ambient Temperature	0 to 70	°C
TSTG	Storage Temperature	-55 to 150	°C
VIN, VOUT	Voltage on Any Pin Relative to VSS	-1.0 to 7.0	V
VCC	Voltage on Vcc Relative to VSS	-1.0 to 7.0	V
Ios	Short Circuit Output Current	50	mA
Pd	Power Dissipation	0.70	W
TSOLDER	Soldering Temperature•Time	260•10	°C•sec

NOTE : Operation at or above Absolute Maximum Ratings can adversely affect device reliability.

**RECOMMENDED DC OPERATING CONDITIONS**

(TA=0°C to 70°C)

SYMBOL	PARAMETER	MIN.	TYP.	MAX.	UNIT
VCC	Power Supply Voltage	4.5	5.0	5.5	V
VIH	Input High Voltage	2.4	-	VCC+1.0	V
VIL	Input Low Voltage	-1.0	-	0.8	V

NOTE : All voltages are referenced to VSS.

**DC CHARACTERISTICS**

(TA=0°C to 70°C, VCC=5V±10%, VSS=0V, unless otherwise noted.)

SYMBOL	PARAMETER	TEST CONDITIONS	SPEED/ POWER	MIN.	MAX.	UNIT	NOTE
I <sub>LI</sub>	Input Leakage Current (Any Input Pins)	V <sub>SS</sub> ≤ V <sub>IN</sub> ≤ V <sub>CC</sub> +1.0 All other pins not under test=V <sub>SS</sub>		-10	10	μA	
I <sub>LO</sub>	Output Leakage Current (High Impedance State)	V <sub>SS</sub> ≤ V <sub>OUT</sub> ≤ V <sub>CC</sub> , R <sub>AS</sub> & C <sub>AS</sub> at V <sub>IH</sub>		-10	10	μA	
I <sub>CC1</sub>	V <sub>CC</sub> Supply Current, Operating	t <sub>RC</sub> =t <sub>RC</sub> (min.)	70	-	100	mA	1,2,3
			80	-	90		
			100	-	80		
I <sub>CC2</sub>	V <sub>CC</sub> Supply Current, TTL Standby	R <sub>AS</sub> & C <sub>AS</sub> at V <sub>IH</sub> , other inputs ≥ V <sub>SS</sub>		-	2	mA	
I <sub>CC3</sub>	V <sub>CC</sub> Supply Current, R <sub>AS</sub> -only refresh	t <sub>RC</sub> =t <sub>RC</sub> (min.)	70	-	100	mA	1,3
			80	-	90		
			100	-	80		
I <sub>CC4</sub>	V <sub>CC</sub> Supply Current, Fast Page mode	t <sub>PC</sub> =t <sub>PC</sub> (min.)	70	-	100	mA	1,2,3
			80	-	90		
			100	-	80		
I <sub>CC5</sub>	V <sub>CC</sub> Supply Current, CMOS Standby	R <sub>AS</sub> & C <sub>AS</sub> ≥ V <sub>CC</sub> - 0.2V		-	1	mA	5
SL-part	-	0.4					
I <sub>CC6</sub>	V <sub>CC</sub> Supply Current, C <sub>AS</sub> -before-R <sub>AS</sub> refresh	t <sub>RC</sub> =t <sub>RC</sub> (min.)	70	-	100	mA	1,3
			80	-	90		
			100	-	80		
I <sub>CC7</sub>	V <sub>CC</sub> Supply Current, Battery Back Up (SL-Part only)	t <sub>RC</sub> =62.5μs, C <sub>AS</sub> =C <sub>BR</sub> cycling or 0.2V, WE=V <sub>CC</sub> - 0.2V, A0-A11=V <sub>CC</sub> - 0.2V or 0.2V, D=V <sub>CC</sub> - 0.2V, 0.2V or open, Q=open	t <sub>RAS</sub> ≤ 300ns	-	450	μA	1,4,5
			t <sub>RAS</sub> ≤ 1μs	-	600		
I <sub>CC8</sub>	V <sub>CC</sub> Supply Current, Self Refresh (SL-Part only)	R <sub>AS</sub> & C <sub>AS</sub> ≤ 0.2V other pins same as I <sub>CC7</sub>			500	μA	5
V <sub>OL</sub>	Output Low Voltage	I <sub>OL</sub> =4.2mA		-	0.4	V	
V <sub>OH</sub>	Output High Voltage	I <sub>OH</sub> =-5mA		2.4	-	V	

**NOTE :**

- I<sub>CC1</sub>, I<sub>CC3</sub>, I<sub>CC4</sub>, I<sub>CC6</sub> and I<sub>CC7</sub> depend on cycle rate.
- I<sub>CC1</sub> and I<sub>CC4</sub> depend on output loading. Specified values are obtained with the output open.
- I<sub>CC</sub> is specified as an average current. In I<sub>CC1</sub> and I<sub>CC3</sub>, Address can be changed maximum two times while R<sub>AS</sub>=V<sub>IL</sub>. In I<sub>CC4</sub>, Address can be changed maximum once while C<sub>AS</sub>=V<sub>IH</sub>.
- t<sub>RAS</sub>(max.)=1μs is only applied to refresh of battery backup but t<sub>RAS</sub>(max.)=10μs is applied to normal functional operating.
- I<sub>CC5</sub>(max.)=0.4mA and I<sub>CC7</sub> and I<sub>CC8</sub> are applied to SL-part only (HY5116810SLJC, HY5116810SLTC and HY5116810SLRC).

**AC CHARACTERISTICS**

(TA=0°C to 70°C, VCC=5V±10%, VSS = 0V, unless otherwise noted.) NOTE : 1, 2, 3

#	SYMBOL	PARAMETER	HY5116810JC/TC/RC/SLJC/SLTC/SLRC						UNIT	NOTE
			-70		-80		-100			
			MIN.	MAX.	MIN.	MAX.	MIN.	MAX.		
1	tRC	Random Read or Write Cycle Time	130	-	150	-	180	-	ns	
2	tRWC	Read-Modify-Write Cycle Time	185	-	205	-	245	-	ns	
3	tPC	Fast Page Mode Cycle Time	45	-	50	-	60	-	ns	
4	tPRWC	Fast Page Mode Read-Modify-Write Cycle Time	100	-	105	-	125	-	ns	
5	tRAC	Access Time from RAS	-	70	-	80	-	100	ns	4,9,10
6	tCAC	Access Time from CAS	-	20	-	20	-	25	ns	4,9
7	tAA	Access Time from Column Address	-	35	-	40	-	50	ns	4,10
8	tCPA	Access Time from CAS Precharge	-	40	-	45	-	55	ns	4
9	tCLZ	CAS to Output Low Impedance	0	-	0	-	0	-	ns	4
10	tOFF	Output Buffer Turn-off Delay	0	15	0	15	0	15	ns	5
11	tT	Transition Time (Rise and Fall)	3	50	3	50	3	50	ns	3
12	tRP	RAS Precharge Time	50	-	60	-	70	-	ns	
13	tRAS	RAS Pulse Width	70	10K	80	10K	100	10K	ns	
14	tRASP	RAS Pulse Width (Fast Page Mode)	70	100K	80	100K	100	100K	ns	
15	tRSH	RAS Hold Time	20	-	20	-	25	-	ns	
16	tCSH	CAS Hold Time	70	-	80	-	100	-	ns	
17	tCAS	CAS Pulse Width	20	10K	20	10K	25	10K	ns	
18	tRCD	RAS to CAS Delay	20	50	20	60	25	75	ns	9
19	tRAD	RAS to Column Address Delay Time	15	35	15	40	20	50	ns	10
20	tCRP	CAS to RAS Precharge Time	5	-	5	-	10	-	ns	
21	tCP	CAS Precharge Time	10	-	10	-	10	-	ns	
22	tASR	Row Address Set-up Time	0	-	0	-	0	-	ns	
23	tRAH	Row Address Hold Time	10	-	10	-	15	-	ns	
24	tASC	Column Address Set-up Time	0	-	0	-	0	-	ns	
25	tCAH	Column Address Hold Time	15	-	15	-	20	-	ns	
26	tAR	Column Address Hold Time from RAS	55	-	60	-	75	-	ns	
27	tRAL	Column Address to RAS Lead Time	35	-	40	-	50	-	ns	
28	tRCS	Read Command Set-up Time	0	-	0	-	0	-	ns	
29	tRCH	Read Command Hold Time Referenced to CAS	0	-	0	-	0	-	ns	6
30	tRRH	Read Command Hold Time Referenced to RAS	0	-	0	-	0	-	ns	6
31	tWCH	Write Command Hold Time	15	-	15	-	20	-	ns	
32	tWCR	Write Command Hold Time from RAS	55	-	60	-	75	-	ns	
33	tWP	Write Command Pulse Width	15	-	15	-	20	-	ns	
34	tRWL	Write Command to RAS Lead Time	20	-	20	-	25	-	ns	
35	tCWL	Write Command to CAS Lead Time	20	-	20	-	25	-	ns	
36	tDS	Data-In Set-up Time	0	-	0	-	0	-	ns	7
37	tDH	Data-In Hold Time	15	-	15	-	20	-	ns	7
38	tDHR	Data-In Hold Time Referenced to RAS	55	-	60	-	75	-	ns	
39	tREF	Refresh Period (4096 cycles)	-	64	-	64	-	64	ms	12
		SL-part	-	256	-	256	-	256	ms	11
40	tWCS	Write Command Set-up Time	0	-	0	-	0	-	ns	8

**AC CHARACTERISTICS**

(continued)

#	SYMBOL	PARAMETER	HY5116810JC/TC/RC/SLJC/SLTC/SLRC						UNIT	NOTE
			-70		-80		-100			
			MIN.	MAX.	MIN.	MAX.	MIN.	MAX.		
41	tCWD	CAS to WE Delay Time	50	-	50	-	60	-	ns	8
42	tRWD	RAS to WE Delay Time	100	-	110	-	135	-	ns	8
43	tAWD	Column Address to WE Delay Time	65	-	70	-	85	-	ns	8
44	tCSR	CAS Set-up Time (CBR Cycle)	10	-	10	-	10	-	ns	
45	tCHR	CAS Hold Time (CBR Cycle)	15	-	15	-	20	-	ns	
46	tRPC	RAS to CAS Precharge Time	10	-	10	-	10	-	ns	
47	tCPT	CAS Precharge Time (CBR Counter Test)	40	-	40	-	50	-	ns	
48	tROH	RAS Hold Time Reference to OE	20	-	20	-	20	-	ns	
49	tOEA	OE Access Time	-	20	-	20	-	25	ns	
50	tOED	OE to Data Delay	20	-	20	-	25	-	ns	
51	tOEZ	Output Buffer Turn Off Delay Time	0	15	0	15	0	15	ns	5
52	tOEH	OE Command Hold Time	20	-	20	-	25	-	ns	
53	tCPWD	WE Delay Time from CAS Precharge	70	-	75	-	90	-	ns	8
54	tRHCP	RAS Hold Time from CAS Precharge	45	-	45	-	55	-	ns	
55	tRASS	RAS Pulse Width (Self Refresh Cycle)	100	-	100	-	100	-	μs	
56	tRPS	RAS Precharge Time (Self Refresh Cycle)	130	-	150	-	180	-	ns	
57	tCHS	CAS Hold Time (Self Refresh Cycle)	-50	-	-50	-	-50	-	ns	
58	tWBS	Write-Per-Bit Set-up Time	0		0		0	-	ns	
59	tWBH	Write-Per-Bit Hold Time	10		10		15	-	ns	
60	tWDS	Write-Per-Bit Selection Set-up Time	0		0		0	-	ns	
61	tWDH	Write-Per-Bit Selection Hold Time	10		10		15	-	ns	

**NOTE :**

1. An initial pause of 200 $\mu$ s is required after power-up followed by any 8 RAS cycles or CAS-before-RAS refresh cycles before proper device operation is achieved. In case of using internal refresh counter, a minimum of 8 CAS-before-RAS initialization cycles instead of 8 RAS-only refresh cycles are required.
2. If RAS= Vss during power-up, the HY5116810 could begin an active cycle. This condition results in higher current than necessary current which is demanded from the power supply during power-up. It is recommended that RAS and CAS track with Vcc during power-up or be held at valid VIH in order to minimize the power-up current.
3. VIH(min.) and VIL(max.) are reference levels for measuring timing of input signals. Transition times are measured between VIH(min.) and VIL(max.), and are assumed to be 5ns for all inputs.
4. Measured at VOH=2.4V and VOL=0.4V with a load equivalent to 2 TTL loads and 100pF.
5. tOFF(max.) and tOEZ define the time at which the output achieves the open circuit condition and is not referenced to output voltage levels.
6. Either tRCH or tRRH must be satisfied for a read cycle.
7. These parameters are referenced to CAS leading edge in early write cycles and to WB/WE leading edge in Read-Modify-Write cycle.
8. twCS, tRWD, tCWD, tAWD and tCPWD are not restrictive operating parameters. They are included in the data sheet as electrical characteristics only. If twCS  $\geq$  twCS(min.), the cycle is an early write cycle and data out pin will remain open circuit (high impedance) through the entire cycle. If tRWD  $\geq$  tRWD(min.), tCWD  $\geq$  tCWD(min.), tAWD  $\geq$  tAWD(min.), and tCPWD  $\geq$  tCPWD(min.), the cycle is a Read-Modify-Write cycle and data out will contain data read from the selected cell. If neither of the above sets of conditions is satisfied, the condition of the data out (at access time) is indetermined.
9. Operation within the tRCD(max.) limit insures that tRAC(max.) can be met. tRCD(max.) is specified as a reference point only. If tRCD is greater than the specified tRCD(max.) limit, then access time is controlled by tCAC.
10. Operation within the tRAD(max.) limit insures that tRAC(max.) can be met. tRAD(max.) is specified as a reference point only. If tRAD is greater than the specified tRAD(max.) limit, then access time is controlled by tAA.
11. tREF(max.)=256ms is applied to SL-parts only (HY5116810SLJC, HY5116810SLTC and HY5116810SLRC).
12. A burst of 4096 CAS-before-RAS refresh cycles must be executed within 64ms (256ms for SL-part) after exiting self refresh.

**CAPACITANCE**

(TA=25°C, Vcc=5V $\pm$ 10%, Vss=0V, f=1MHz, unless otherwise noted.)

SYMBOL	PARAMETER	TYP.	MAX.	UNIT
CIN1	Input Capacitance (A0-A11)	-	5	pF
CIN2	Input Capacitance (RAS, CAS, WB/WE, OE)	-	7	pF
CDQ	Write Mask / Data I/O Capacitance (W/DQ0-W/DQ7)	-	7	pF

**TIMING DIAGRAM**

**READ CYCLE**

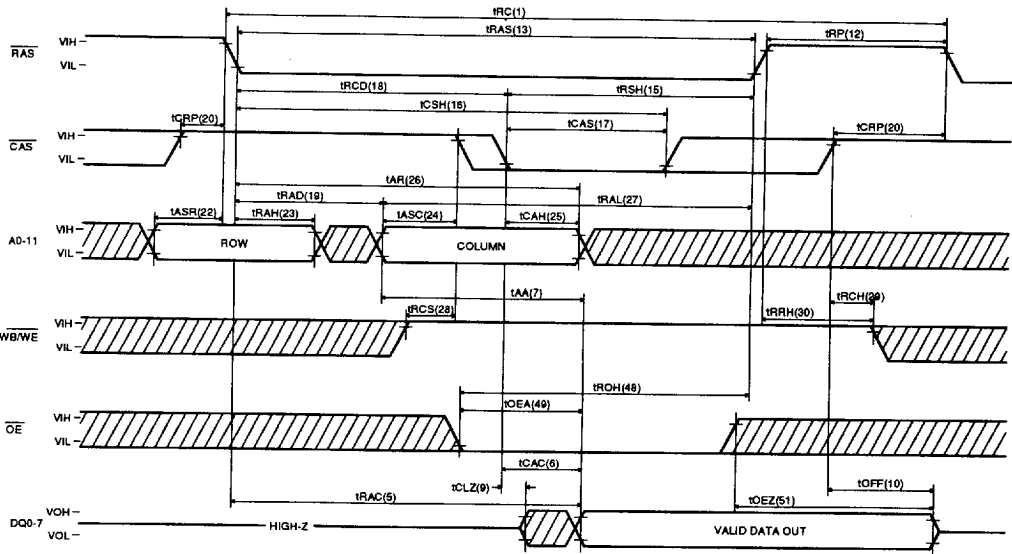

**EARLY WRITE CYCLE**

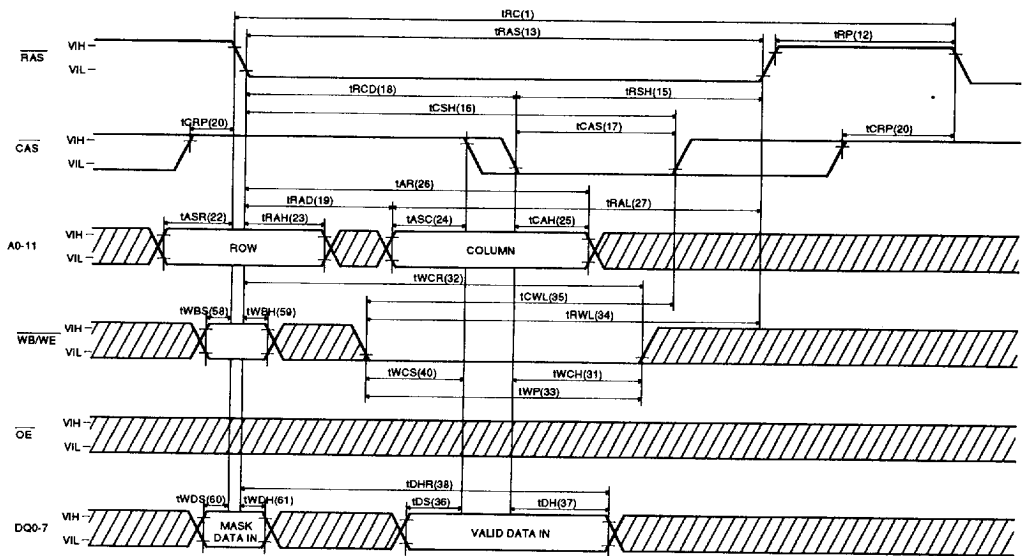

WRITE CYCLE (OE CONTROLLED WRITE)

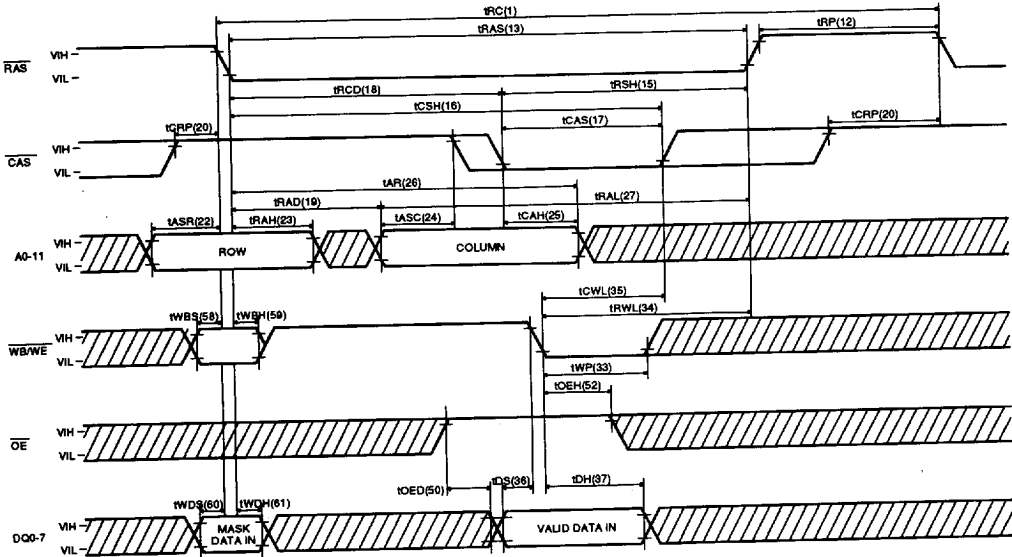

READ-MODIFY-WRITE CYCLE

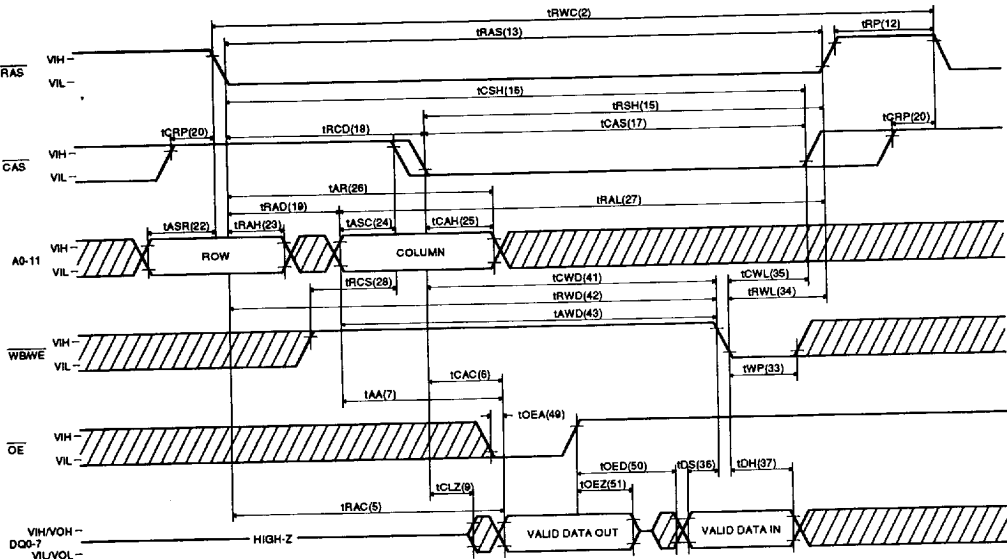



**FAST PAGE MODE READ CYCLE**

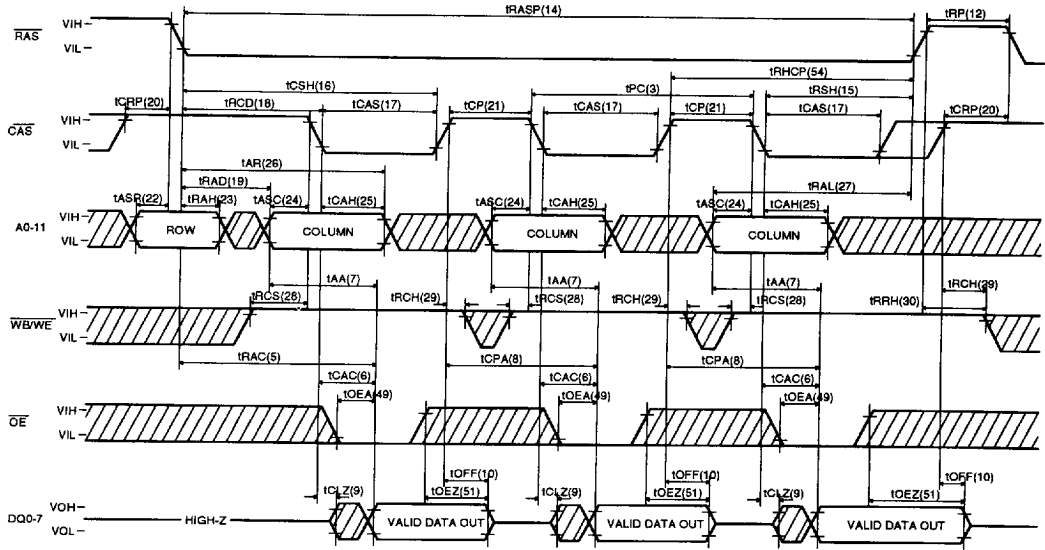

**FAST PAGE MODE EARLY WRITE CYCLE**

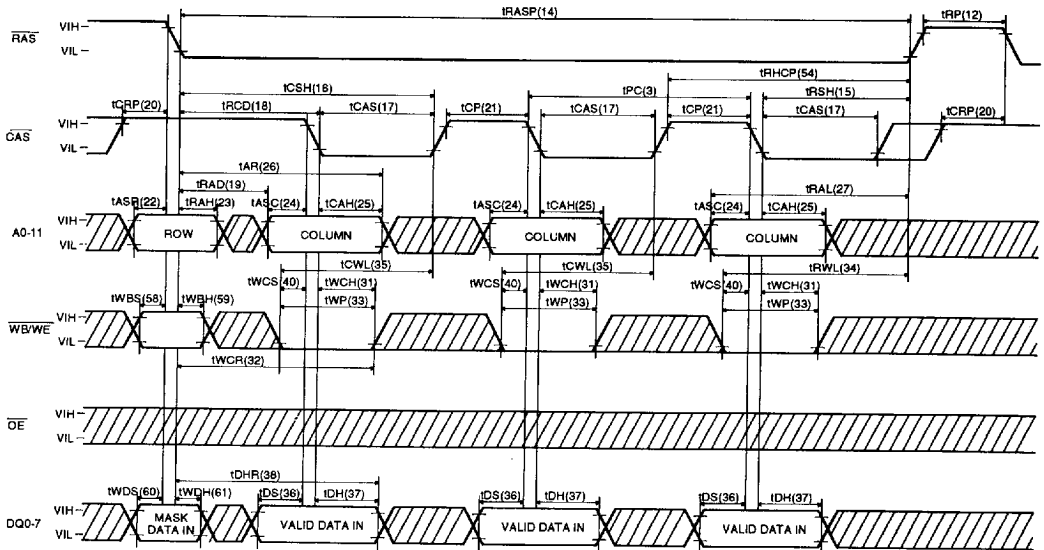



**CAS-BEFORE-RAS REFRESH CYCLE**

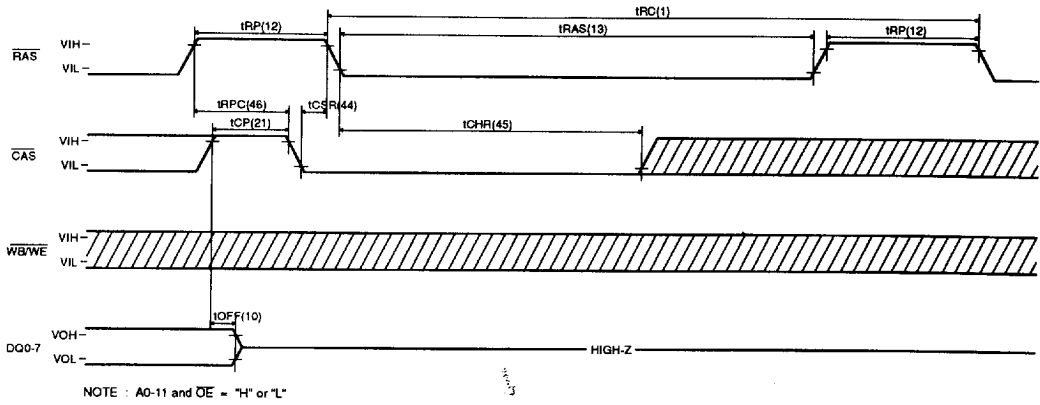

**HIDDEN REFRESH CYCLE (READ)**

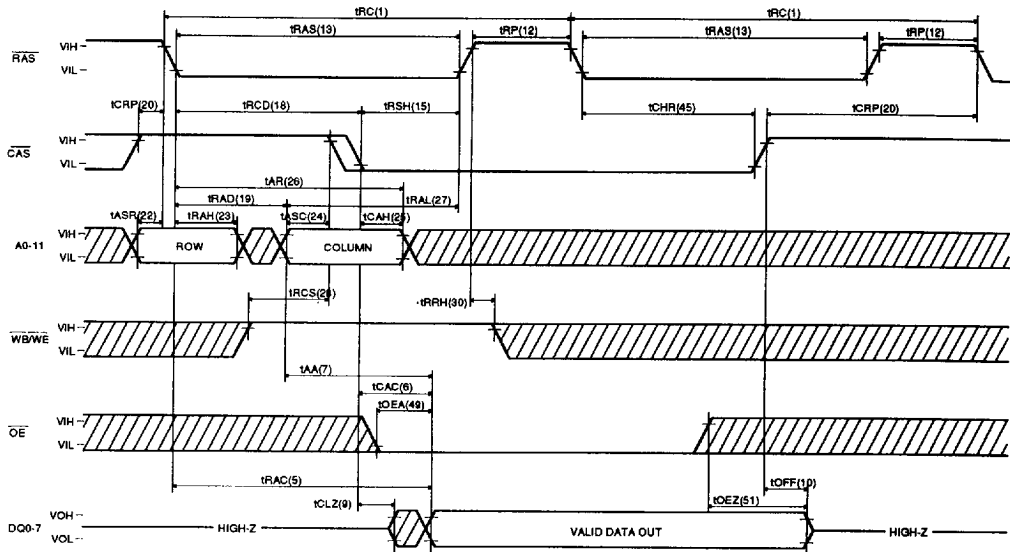

**HIDDEN REFRESH CYCLE (WRITE)**

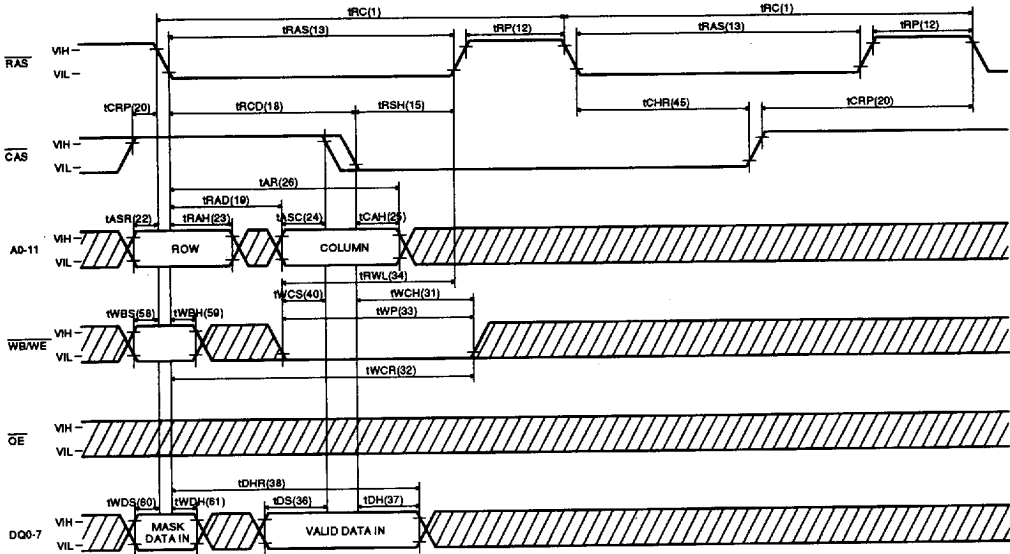

**CAS-BEFORE-RAS SELF REFRESH CYCLE**

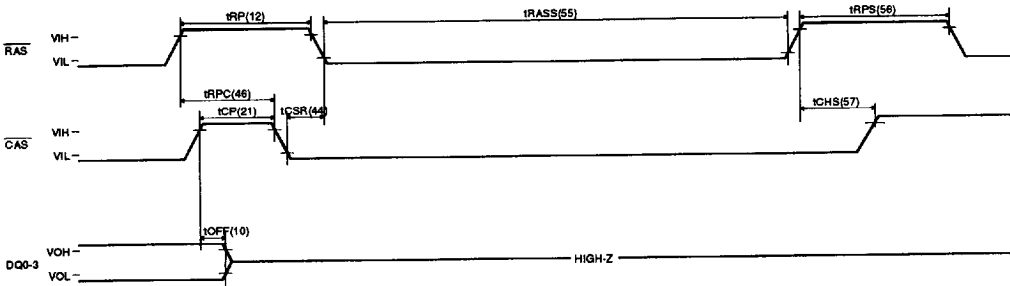

NOTE :A0-11, OE and WE = "H" or "L"



**PACKAGE INFORMATION**

**400 mil 28/28 pin Small Outline J-form Package (JC)**

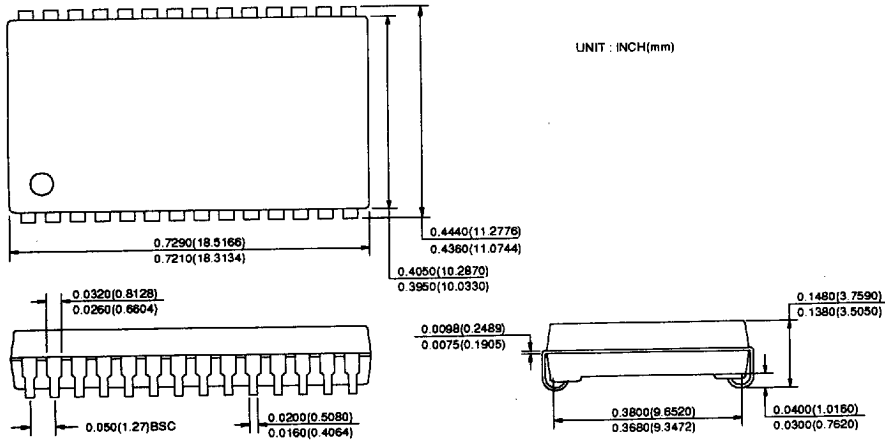

**400 mil 28/28 pin Thin Small Outline Package (TC) (RC)**

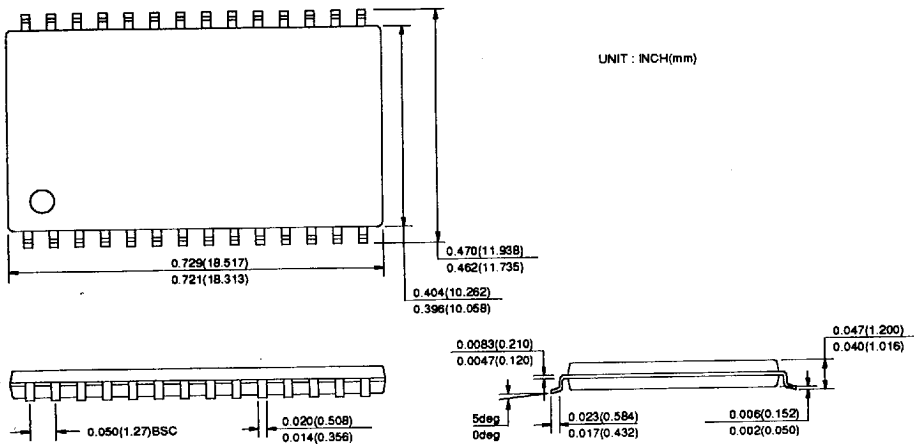

**ORDERING INFORMATION**

<b>PART NO</b>	<b>SPEED</b>	<b>POWER</b>	<b>PACKAGE</b>
HY5116810JC	70/80/100		SOJ
HY5116810SLJC	70/80/100	SL-part	SOJ
HY5116810TC	70/80/100		TSOP-II
HY5116810SLTC	70/80/100	SL-part	TSOP-II
HY5116810RC	70/80/100		TSOP-II(R)
HY5116810SLRC	70/80/100	SL-part	TSOP-II(R)