

Technical Data Sheet

Chip LED with Right Angle Resin

27-21/T3D-AP2Q2HY/3C

Features

- Package in 8mm tape on 7" diameter reel.
- Compatible with automatic placement equipment.
- Compatible with infrared and vapor phase reflow solder process.
- Mono-color type.
- Pb-free.
- The product itself will remain within RoHS compliant version.



Descriptions

- The 27-21 SMD LED is much smaller than lead frame type components, thus enable smaller board size, higher packing density, reduced storage space and finally smaller equipment to be obtained.
- Besides, lightweight makes them ideal for miniature applications. etc.

Applications

- Backlighting in dashboard and switch.
- Telecommunication: indicator and backlighting in telephone and fax.
- Flat backlight for LCD, switch and symbol.
- General use.

Device Selection Guide

| Part No. | Chip | Emitted Color | Resin Color |
|----------------------|----------|---------------|-----------------|
| | Material | | |
| 27-21/T3D-AP2Q2HY/3C | InGaN | Pure White | Yellow Diffused |

Package Outline Dimensions

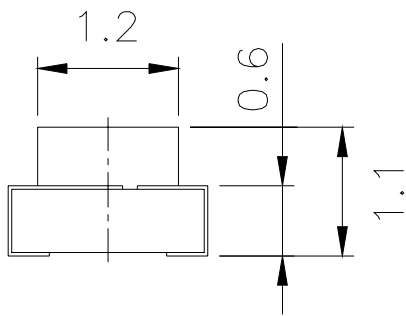
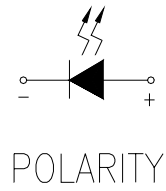
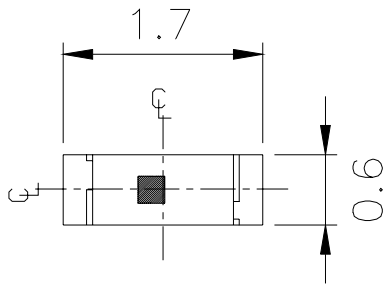

For Reflow Soldering (propose)

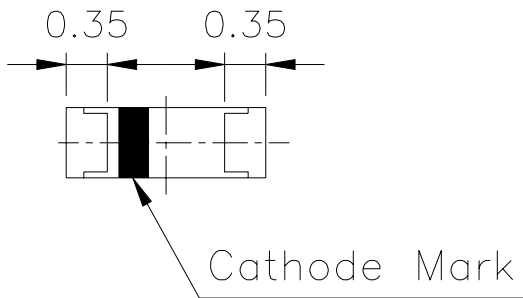
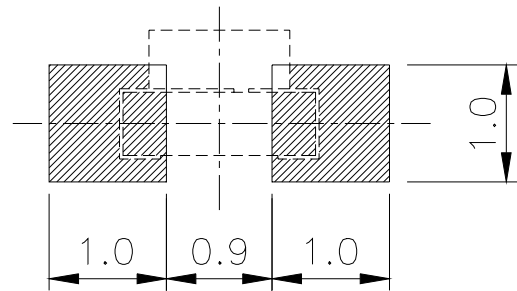

Note: The tolerances unless mentioned is ± 0.1 mm, Unit = mm.

27-21/T3D-AP2Q2HY/3C

Absolute Maximum Ratings (Ta=25°C)

| Parameter | Symbol | Rating | Unit |
|---|-----------------|--|------|
| Reverse Voltage | V _R | 5 | V |
| Forward Current | I _F | 25 | mA |
| Peak Forward Current (Duty 1/10 @1KHz) | I _{FP} | 100 | mA |
| Power Dissipation | P _d | 110 | mW |
| Electrostatic Discharge(HBM) | ESD | 150 | V |
| Operating Temperature | Topr | -40 ~ +85 | °C |
| Storage Temperature | Tstg | -40 ~ +90 | °C |
| Soldering Temperature | Tsol | Reflow Soldering : 260°C for 10sec. Hand Soldering : 350°C for 3 sec. | |

Electro-Optical Characteristics (Ta=25°C)

| Parameter | Symbol | Min. | Typ. | Max. | Unit | Condition |
|--------------------|----------------|-------|-------|-------|------|---------------------|
| Luminous Intensity | I _v | 57.0 | ----- | 112 | mcd | I _F =5mA |
| Viewing Angle | 2θ 1/2 | ----- | 140 | ----- | deg | |
| Forward Voltage | V _F | 2.70 | ----- | 3.15 | V | |
| Reverse Current | I _R | ----- | ----- | 50 | μA | V _R =5V |

Notes:

- 1.Tolerance of Luminous Intensity ±11%**
- 2.Tolerance of Forward Voltage ±0.1V**

27-21/T3D-AP2Q2HY/3C

Bin Range Of Luminous Intensity

| Bin | Min. | Max. | Unit | Condition |
|-----|------|------|------|---------------------|
| P2 | 57.0 | 72.0 | mcd | I _F =5mA |
| Q1 | 72.0 | 90.0 | | |
| Q2 | 90.0 | 112 | | |

Bin Range Of Luminous Voltage

| Group | Bin | Min | Max | Unit | Condition |
|-------|-----|------|------|------|---------------------|
| H | 15 | 2.70 | 2.85 | V | I _F =5mA |
| | 16 | 2.85 | 3.00 | | |
| | 17 | 3.00 | 3.15 | | |

Notes:

1. Tolerance of Luminous Intensity $\pm 11\%$
2. Tolerance of Forward Voltage $\pm 0.1V$

27-21/T3D-AP2Q2HY/3C

Chromaticity Coordinates Specifications for Bin Grading

I_F= 5mA

| Groups | Bin Code | CIE_x | CIE_y |
|--------|----------|-------|-------|
| A | 1 | 0.274 | 0.226 |
| | | 0.274 | 0.258 |
| | | 0.294 | 0.286 |
| | | 0.294 | 0.254 |
| | 2 | 0.274 | 0.258 |
| | | 0.274 | 0.291 |
| | | 0.294 | 0.319 |
| | | 0.294 | 0.286 |
| | 3 | 0.294 | 0.254 |
| | | 0.294 | 0.286 |
| | | 0.314 | 0.315 |
| | | 0.314 | 0.282 |
| | 4 | 0.294 | 0.286 |
| | | 0.294 | 0.319 |
| | | 0.314 | 0.347 |
| | | 0.314 | 0.315 |
| | 5 | 0.314 | 0.282 |
| | | 0.314 | 0.315 |
| | | 0.334 | 0.343 |
| | | 0.334 | 0.311 |
| | 6 | 0.314 | 0.315 |
| | | 0.314 | 0.347 |
| | | 0.334 | 0.376 |
| | | 0.334 | 0.343 |

Notes:

- 1.The C.I.E. 1931 chromaticity diagram (Tolerance ± 0.01).**
- 2.The products are sensitive to static electricity and care must be fully taken when handling products.**

CIE Chromaticity Diagram

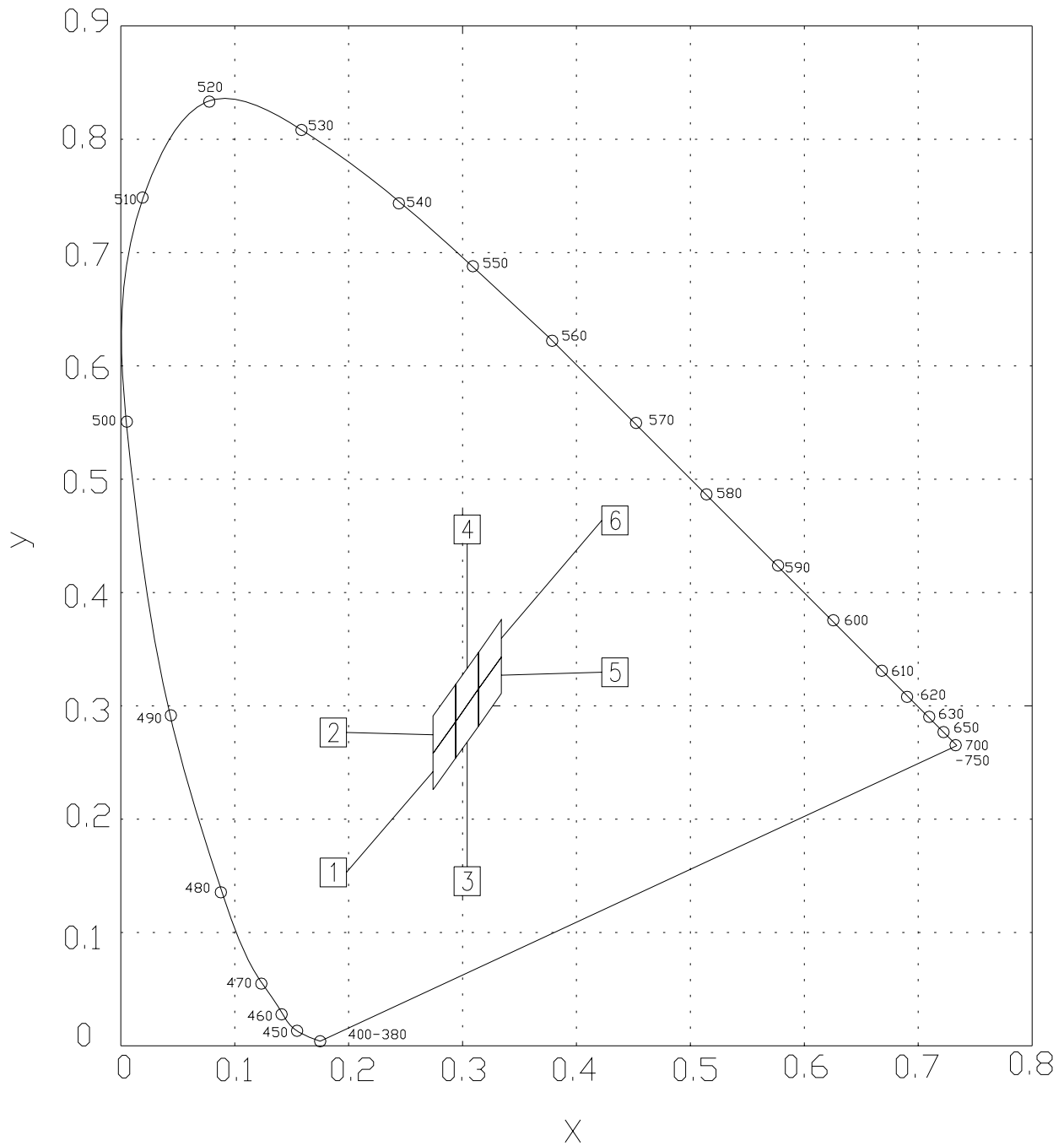

27-21/T3D-AP2Q2HY/3C

Typical Electro-Optical Characteristics Curves

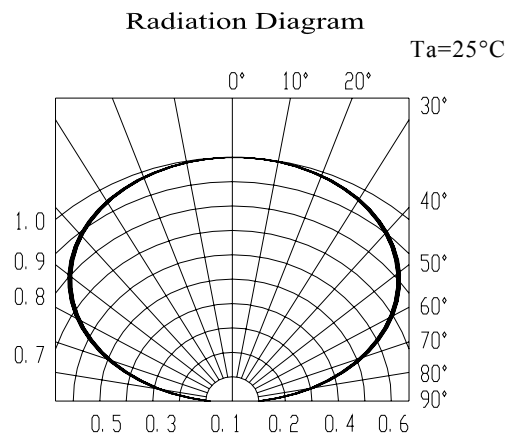
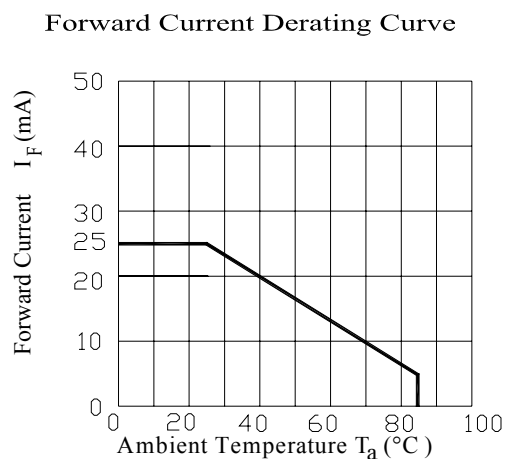
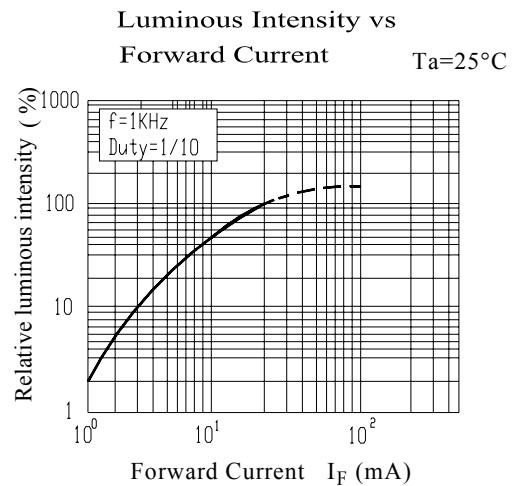
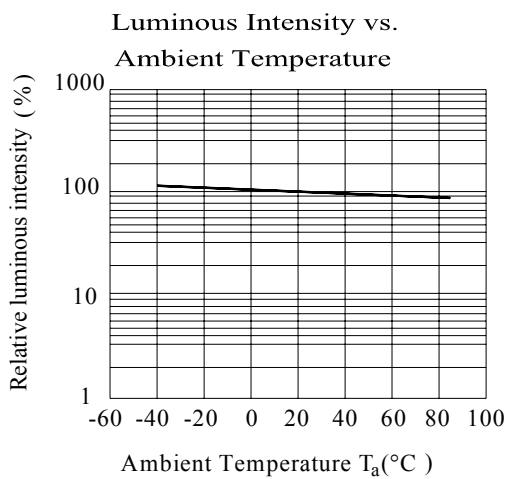
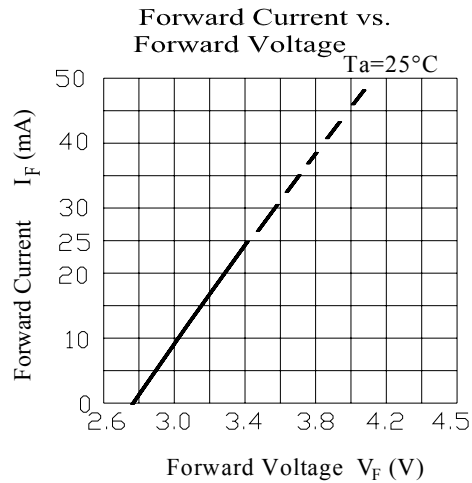
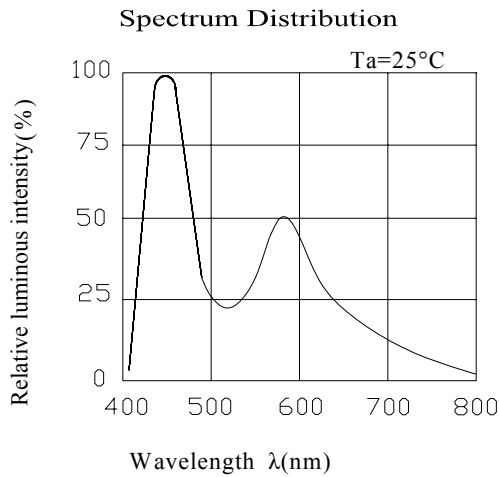

27-21/T3D-AP2Q2HY/3C

Label explanation

CAT: Luminous Intensity Rank

HUE: Chromaticity Coordinates

REF: Forward Voltage Rank



Reel Dimensions

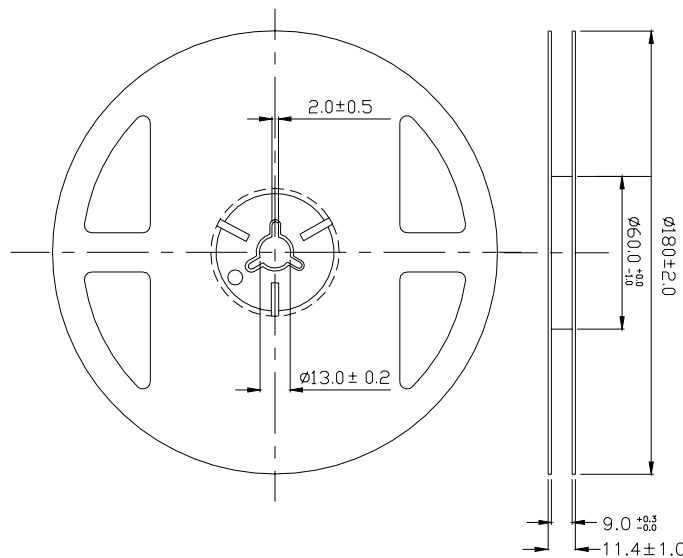

Note: The tolerances unless mentioned is ± 0.1 mm, Unit = mm

27-21/T3D-AP2Q2HY/3C

Carrier Tape Dimensions: Loaded quantity 3000 PCS per reel

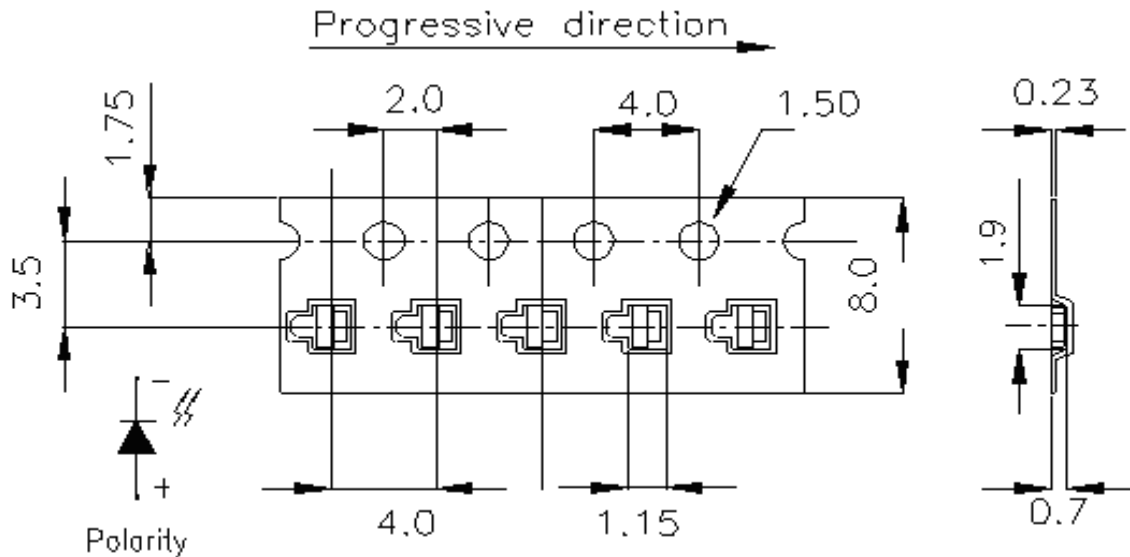

Note: The tolerances unless mentioned is ± 0.1 mm, Unit = mm

Moisture Resistant Packaging

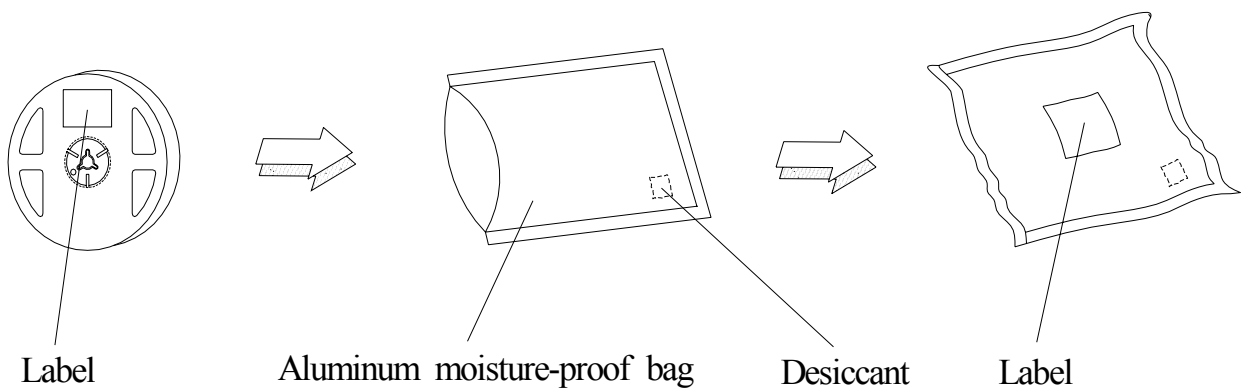

Reliability Test Items And Conditions

The reliability of products shall be satisfied with items listed below.

Confidence level : 90%

LTPD : 10%

| No. | Items | Test Condition | Test Hours/Cycles | Sample Size | Ac/Re |
|-----|----------------------------------|--|-------------------|-------------|-------|
| 1 | Reflow Soldering | Temp. : 260°C±5°C Min. 5sec. | 6 Min. | 22 PCS. | 0/1 |
| 2 | Temperature Cycle | H : +100°C 15min ∫ 5 min L : -40°C 15min | 300 Cycles | 22 PCS. | 0/1 |
| 3 | Thermal Shock | H : +100°C 5min ∫ 10 sec L : -10°C 5min | 300 Cycles | 22 PCS. | 0/1 |
| 4 | High Temperature Storage | Temp. : 100°C | 1000 Hrs. | 22 PCS. | 0/1 |
| 5 | Low Temperature Storage | Temp. : -40°C | 1000 Hrs. | 22 PCS. | 0/1 |
| 6 | DC Operating Life | I _F = 20 mA | 1000 Hrs. | 22 PCS. | 0/1 |
| 7 | High Temperature / High Humidity | 85°C / 85%RH | 1000 Hrs. | 22 PCS. | 0/1 |

Precautions For Use

1. Over-current-proof

Customer must apply resistors for protection , otherwise slight voltage shift will cause big current change (Burn out will happen).

2. Storage

2.1 Do not open moisture proof bag before the products are ready to use.

2.2 Before opening the package: The LEDs should be kept at 30°C or less and 90%RH or less.

2.3 After opening the package: The LED's floor life is 1 year under 30°C or less and 60% RH or less.

If unused LEDs remain, it should be stored in moisture proof packages.

2.4 If the moisture absorbent material (silica gel) has faded away or the LEDs have exceeded the storage time, baking treatment should be performed using the following conditions.

Baking treatment : 60±5°C for 24 hours.

3. Soldering Condition

3.1 Pb-free solder temperature profile

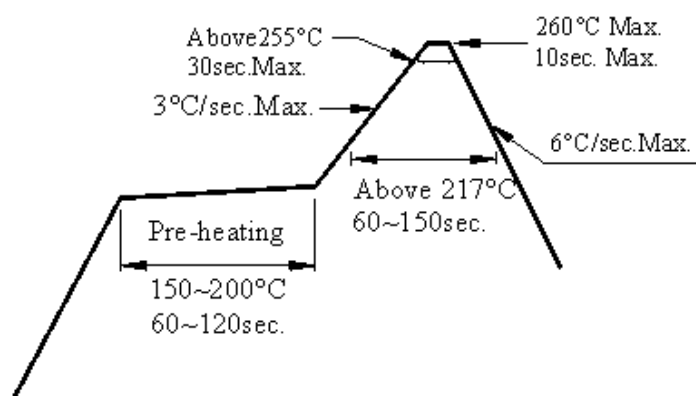

3.2 Reflow soldering should not be done more than two times.

3.3 When soldering, do not put stress on the LEDs during heating.

3.4 After soldering, do not warp the circuit board.

4.Soldering Iron

Each terminal is to go to the tip of soldering iron temperature less than 350°C for 3 seconds within once in less than the soldering iron capacity 25W. Leave two seconds and more intervals, and do soldering of each terminal. Be careful because the damage of the product is often started at the time of the hand solder.

5.Repairing

Repair should not be done after the LEDs have been soldered. When repairing is unavoidable, a double-head soldering iron should be used (as below figure). It should be confirmed beforehand whether the characteristics of the LEDs will or will not be damaged by repairing.

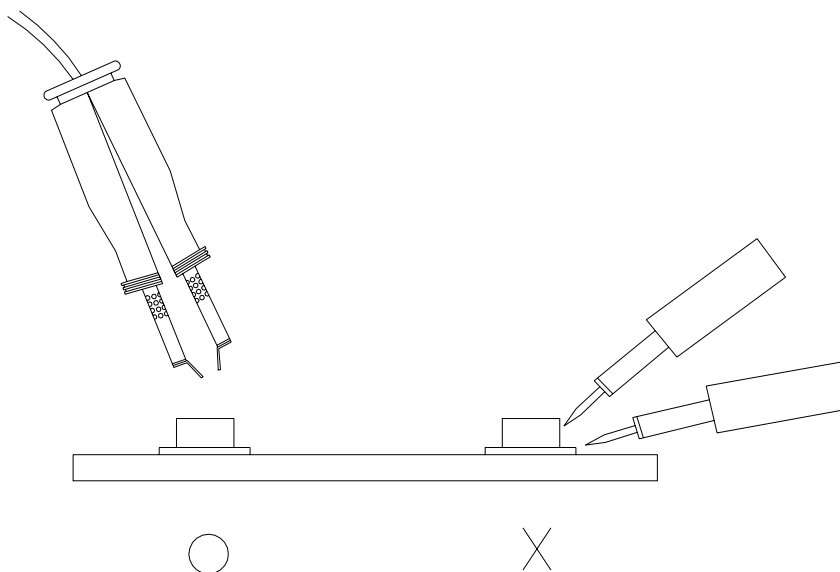

EVERLIGHT ELECTRONICS CO., LTD.

Office: No 25, Lane 76, Sec 3, Chung Yang Rd,
Tucheng, Taipei 236, Taiwan, R.O.C

Tel: 886-2-2267-2000, 2267-9936

Fax: 886-2267-6244, 2267-6189, 2267-6306

<http://www.everlight.com>