

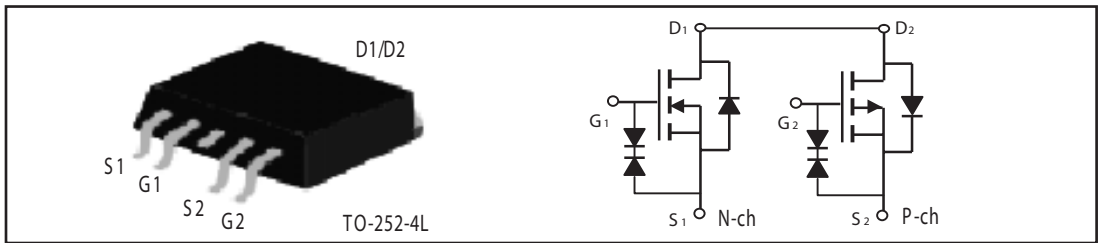

## Dual Enhancement Mode Field Effect Transistor ( N and P Channel)

PRODUCT SUMMARY (N-Channel)		
V <sub>DSS</sub>	I <sub>D</sub>	R <sub>DS(ON)</sub> ( mΩ ) Max
40V	16A	30 @ V <sub>GS</sub> = 10V
		40 @ V <sub>GS</sub> = 4.5V

PRODUCT SUMMARY (P-Channel)		
V <sub>DSS</sub>	I <sub>D</sub>	R <sub>DS(ON)</sub> ( mΩ ) Max
-40V	-12A	48 @ V <sub>GS</sub> = -10V
		65 @ V <sub>GS</sub> = -4.5V



### ABSOLUTE MAXIMUM RATINGS (T<sub>A</sub>=25°C unless otherwise noted)

Parameter		Symbol	N-Channel	P-Channel	Unit
Drain-Source Voltage		V <sub>DS</sub>	40	-40	V
Gate-Source Voltage		V <sub>GS</sub>	±20	±20	V
Drain Current-Continuous @ T <sub>c</sub>	25°C	I <sub>D</sub>	16	-12	A
	70°C		13.8	-10	A
-Pulsed <sup>a</sup>		I <sub>DM</sub>	50	-50	A
Drain-Source Diode Forward Current		I <sub>S</sub>	8	-6	A
Maximum Power Dissipation	T <sub>c</sub> = 25°C	P <sub>D</sub>	11		W
	T <sub>c</sub> = 70°C		7.7		
Operating Junction and Storage Temperature Range		T <sub>J</sub> , T <sub>STG</sub>	-55 to 175		°C

### THERMAL CHARACTERISTICS

Thermal Resistance, Junction-to-Case	R <sub>θJC</sub>	13.6	°C/W
Thermal Resistance, Junction-to-Ambient	R <sub>θJA</sub>	120	°C/W

# STU407D

N-Channel ELECTRICAL CHARACTERISTICS ( $T_A = 25\text{ }^\circ\text{C}$  unless otherwise noted)

Parameter	Symbol	Condition	Min	Typ <sup>c</sup>	Max	Unit
<b>OFF CHARACTERISTICS</b>						
Drain-Source Breakdown Voltage	$BV_{DSS}$	$V_{GS}=0V, I_D=250\mu A$	40			V
Zero Gate Voltage Drain Current	$I_{DSS}$	$V_{DS}=32V, V_{GS}=0V$			1	$\mu A$
Gate-Body Leakage	$I_{GSS}$	$V_{GS}=\pm 20V, V_{DS}=0V$			$\pm 10$	$\mu A$
<b>ON CHARACTERISTICS<sup>a</sup></b>						
Gate Threshold Voltage	$V_{GS(th)}$	$V_{DS}=V_{GS}, I_D=250\mu A$	1	1.8	3	V
Drain-Source On-State Resistance	$R_{DS(ON)}$	$V_{GS}=10V, I_D=8A$		22	30	m ohm
		$V_{GS}=4.5V, I_D=6A$		30	40	m ohm
On-State Drain Current	$I_{D(ON)}$	$V_{DS}=5V, V_{GS}=4.5V$	20			A
Forward Transconductance	$g_{FS}$	$V_{DS}=10V, I_D=8A$		15		S
<b>DYNAMIC CHARACTERISTICS<sup>b</sup></b>						
Input Capacitance	$C_{ISS}$	$V_{DS}=20V, V_{GS}=0V$ $f=1.0MHz$		735		pF
Output Capacitance	$C_{OSS}$			120		pF
Reverse Transfer Capacitance	$C_{RSS}$			70		pF
Gate resistance	$R_g$	$V_{GS}=0V, V_{DS}=0V, f=1.0MHz$		0.36		ohm
<b>SWITCHING CHARACTERISTICS<sup>b</sup></b>						
Turn-On Delay Time	$t_{D(ON)}$	$V_{DD}=20V$ $I_D=3A$ $V_{GS}=10V$ $R_{GEN}=3\text{ ohm}$		13		ns
Rise Time	$t_r$			15		ns
Turn-Off Delay Time	$t_{D(OFF)}$			26		ns
Fall Time	$t_f$			10		ns
Total Gate Charge	$Q_g$	$V_{DS}=20V, I_D=8A, V_{GS}=10V$		15		nC
		$V_{DS}=20V, I_D=8A, V_{GS}=4.5V$		7.2		nC
Gate-Source Charge	$Q_{gs}$	$V_{DS}=20V, I_D=8A$ $V_{GS}=10V$		2.0		nC
Gate-Drain Charge	$Q_{gd}$			3.8		nC

# STU407D

P-Channel ELECTRICAL CHARACTERISTICS ( $T_A = 25\text{ }^{\circ}\text{C}$  unless otherwise noted)

Parameter	Symbol	Condition	Min	Typ <sup>c</sup>	Max	Unit
<b>OFF CHARACTERISTICS</b>						
Drain-Source Breakdown Voltage	$BV_{DSS}$	$V_{GS}=0V, I_D=-250\mu A$	-40			V
Zero Gate Voltage Drain Current	$I_{DSS}$	$V_{DS}=-32V, V_{GS}=0V$			-1	$\mu A$
Gate-Body Leakage	$I_{GSS}$	$V_{GS}=\pm 20V, V_{DS}=0V$			$\pm 10$	$\mu A$
<b>ON CHARACTERISTICS<sup>a</sup></b>						
Gate Threshold Voltage	$V_{GS(th)}$	$V_{DS}=V_{GS}, I_D=-250\mu A$	-1	-1.6	-3	V
Drain-Source On-State Resistance	$R_{DS(ON)}$	$V_{GS}=-10V, I_D=-6A$		40	48	m ohm
		$V_{GS}=-4.5V, I_D=-4A$		50	65	m ohm
On-State Drain Current	$I_{D(ON)}$	$V_{DS}=-5V, V_{GS}=-10V$	-20			A
Forward Transconductance	$g_{FS}$	$V_{DS}=-10V, I_D=-6A$		9		S
<b>DYNAMIC CHARACTERISTICS<sup>b</sup></b>						
Input Capacitance	$C_{ISS}$	$V_{DS}=-20V, V_{GS}=0V$ $f=1.0MHz$		920		pF
Output Capacitance	$C_{OSS}$			135		pF
Reverse Transfer Capacitance	$C_{RSS}$			75		pF
Gate resistance	$R_g$	$V_{GS}=0V, V_{DS}=0V, f=1.0MHz$		3.5		ohm
<b>SWITCHING CHARACTERISTICS<sup>b</sup></b>						
Turn-On Delay Time	$t_{D(ON)}$	$V_{DD}=-20V$ $I_D=-3A$ $V_{GS}=-10V$ $R_{GEN}=3\text{ ohm}$		12		ns
Rise Time	$t_r$			13		ns
Turn-Off Delay Time	$t_{D(OFF)}$			60		ns
Fall Time	$t_f$			25		ns
Total Gate Charge	$Q_g$	$V_{DS}=-20V, I_D=-6A, V_{GS}=-10V$		15		nC
		$V_{DS}=-20V, I_D=-6A, V_{GS}=-4.5V$		7.2		nC
Gate-Source Charge	$Q_{gs}$	$V_{DS}=-20V, I_D=-6A$		2		nC
Gate-Drain Charge	$Q_{gd}$	$V_{GS}=-10V$		4.0		nC

# STU407D

## ELECTRICAL CHARACTERISTICS ( $T_A=25^{\circ}\text{C}$ unless otherwise noted)

Parameter	Symbol	Condition	Min	Typ <sup>c</sup>	Max	Unit
<b>DRAIN-SOURCE DIODE CHARACTERISTICS<sup>b</sup></b>						
Diode Forward Voltage	$V_{SD}$	$V_{GS} = 0V, I_S = 8A$ $V_{GS} = 0V, I_S = -6A$	N-Ch P-Ch	0.94 -0.87	1.2 -1.2	V

### Notes

- a. Pulse Test: Pulse Width  $\leq 300 \mu s$ , Duty Cycle  $\leq 2\%$ .
- b. Guaranteed by design, not subject to production testing.

### N-Channel

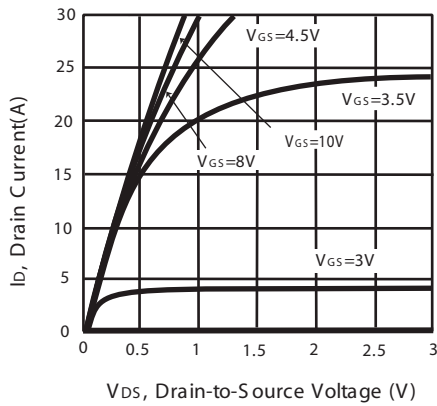

Figure 1. Output Characteristics

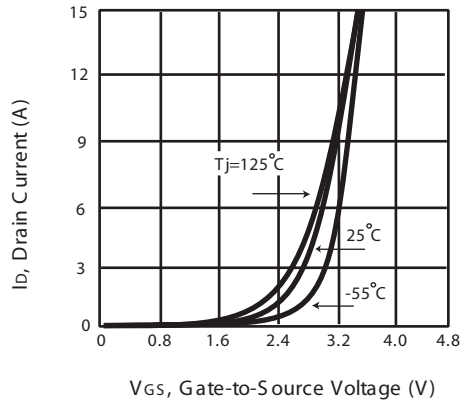

Figure 2. Transfer Characteristics

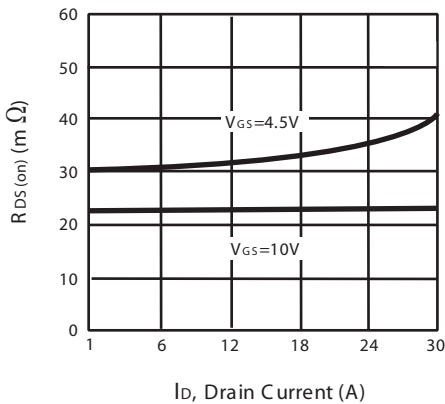

Figure 3. On-Resistance vs. Drain Current and Gate Voltage

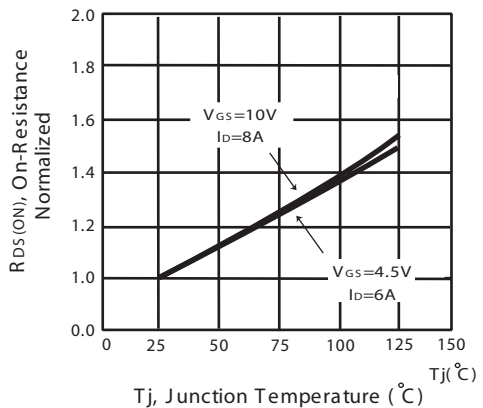

Figure 4. On-Resistance Variation with Drain Current and Temperature

# STU407D

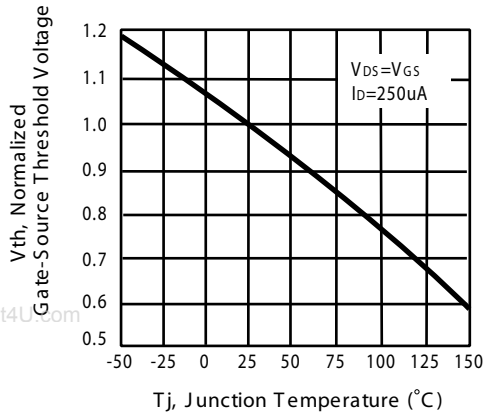

Figure 5. Gate Threshold Variation with Temperature

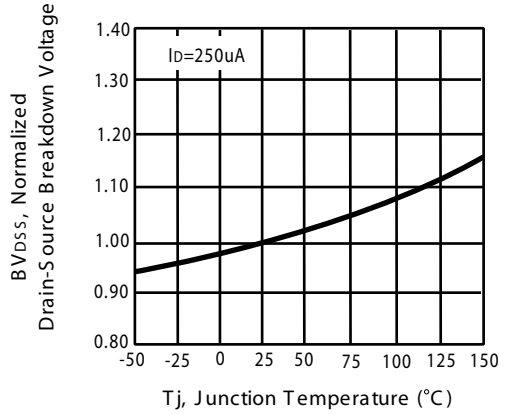

Figure 6. Breakdown Voltage Variation with Temperature

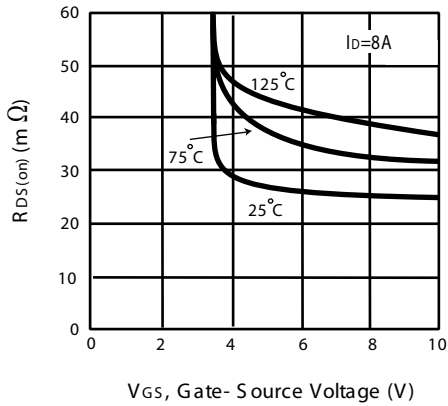

Figure 7. On-Resistance vs. Gate-Source Voltage

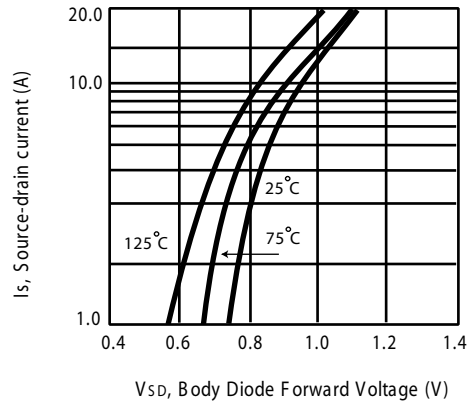

Figure 8. Body Diode Forward Voltage Variation with Source Current

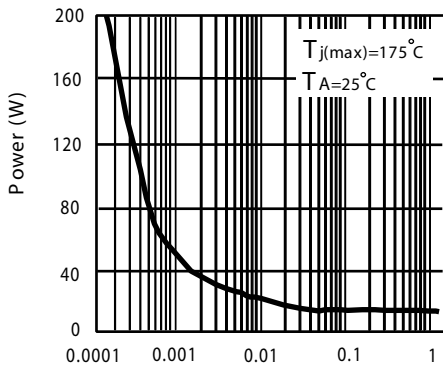
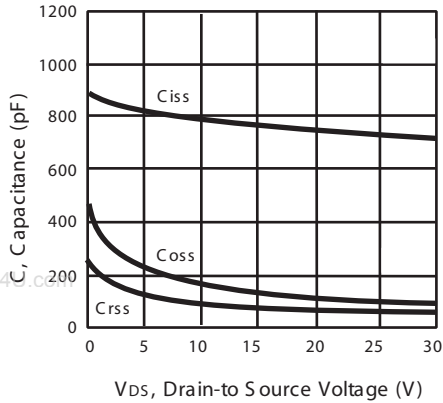

Figure 9. Single Pulse Power Rating Junction-to-Case

# STU407D



$V_{DS}$ , Drain-to Source Voltage (V)

Figure 10. Capacitance

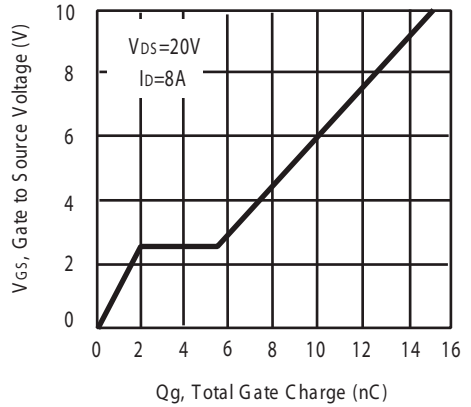

Figure 11. Gate Charge

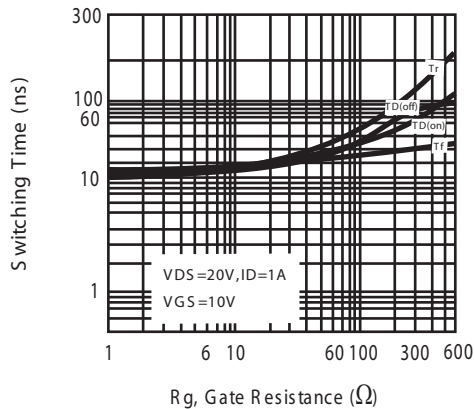

Figure 12. switching characteristics

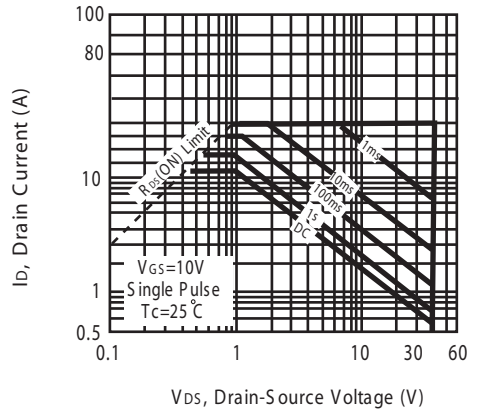

Figure 13. Maximum Safe Operating Area

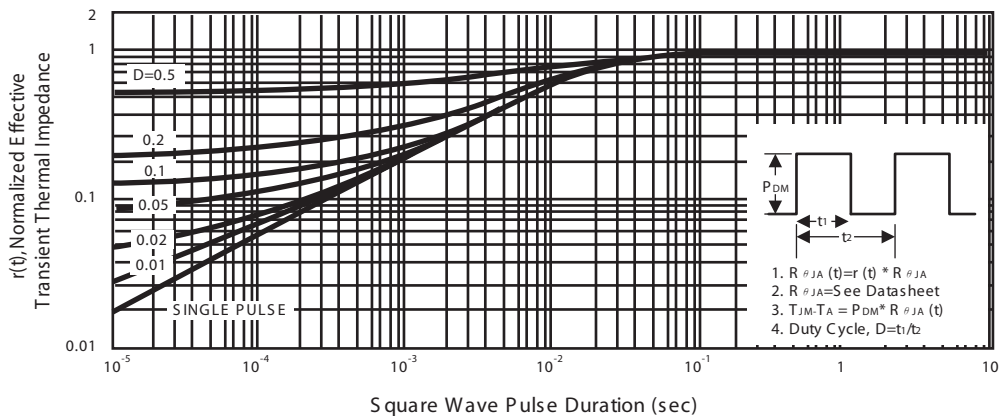

Figure 14. Normalized Thermal Transient Impedance

# STU407D

## P-Channel

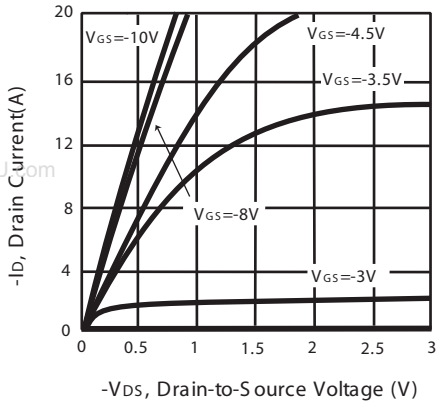

Figure 1. Output Characteristics

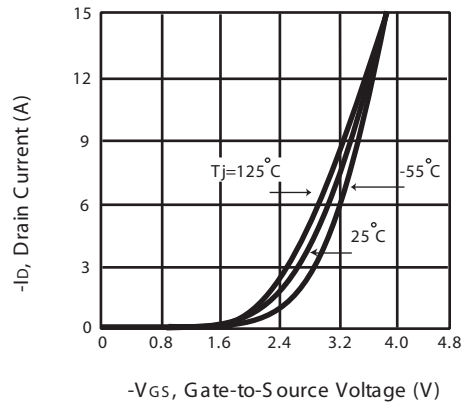

Figure 2. Transfer Characteristics

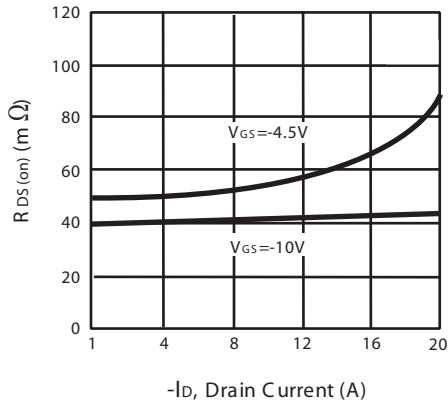

Figure 3. On-Resistance vs. Drain Current and Gate Voltage

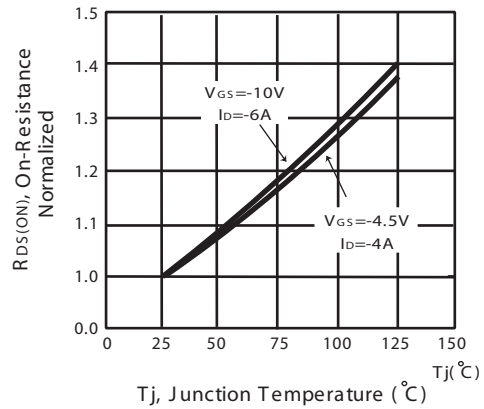

Figure 4. On-Resistance Variation with Drain Current and Temperature

# STU407D

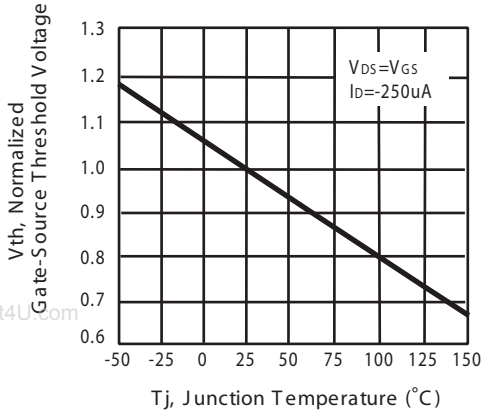

Figure 5. Gate Threshold Variation with Temperature

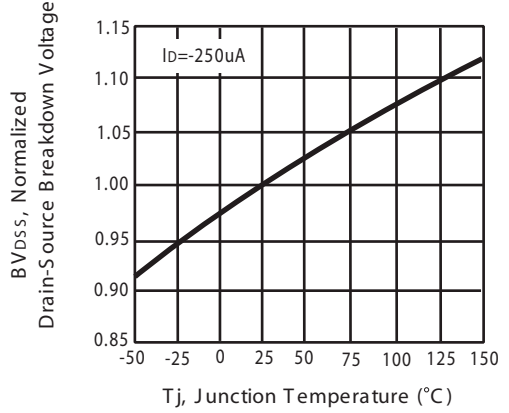

Figure 6. Breakdown Voltage Variation with Temperature

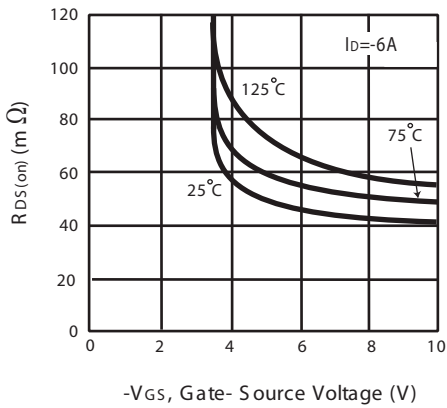

Figure 7. On-Resistance vs. Gate-Source Voltage

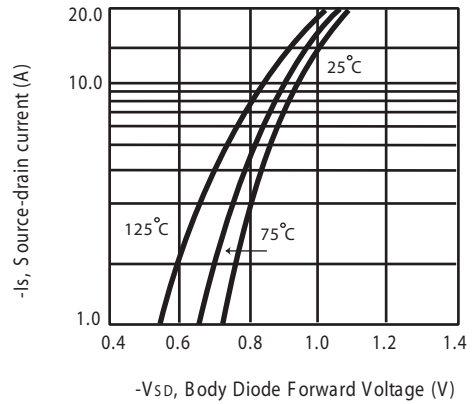

Figure 8. Body Diode Forward Voltage Variation with Source Current

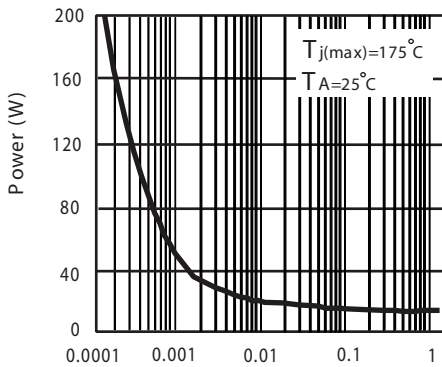

Figure 9. Single Pulse Power Rating Junction-to-Case



# STU407D

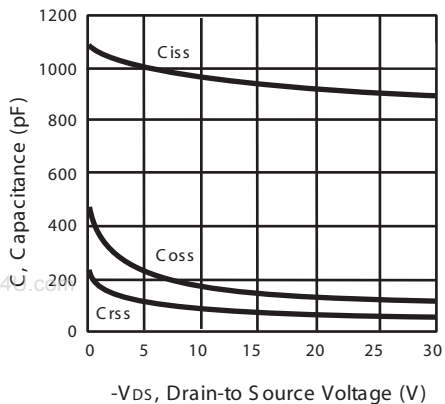

Figure 10. Capacitance

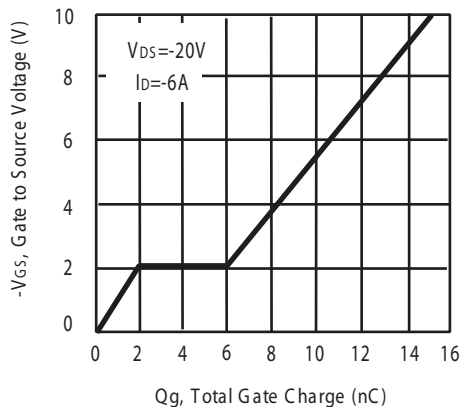

Figure 11. Gate Charge

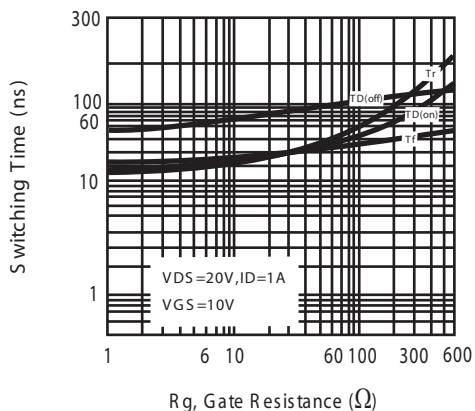

Figure 12. switching characteristics

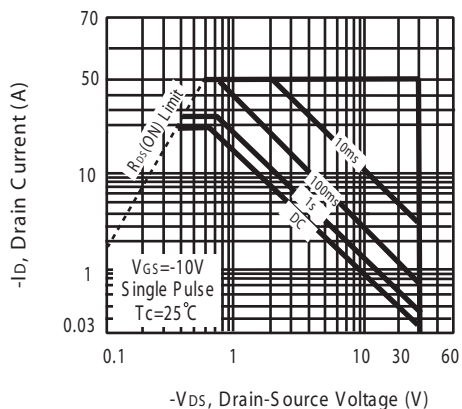

Figure 13. Maximum Safe Operating Area

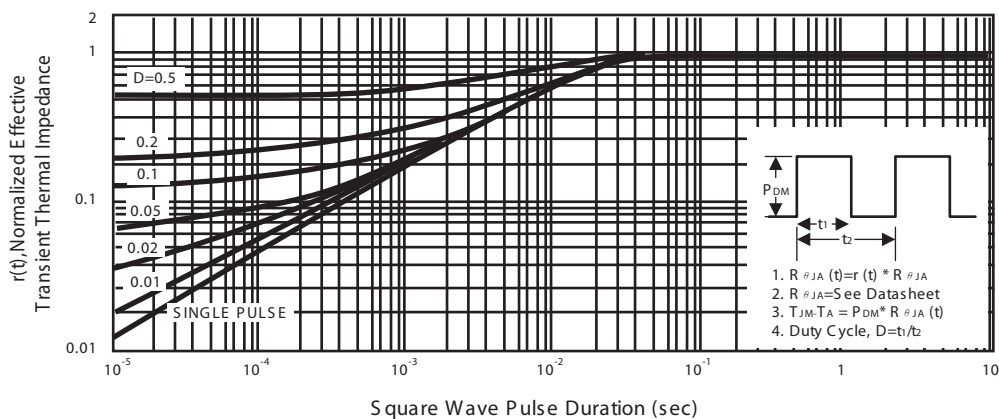
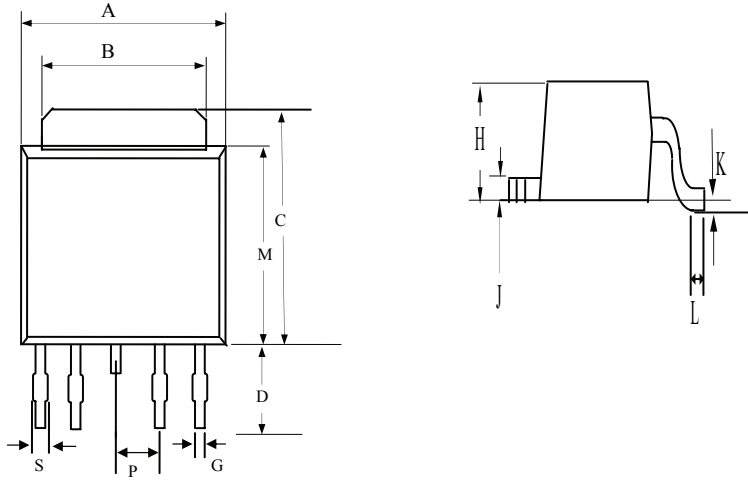

Figure 14. Normalized Thermal Transient Impedance Curve [www.DataSheet4U.com](http://www.DataSheet4U.com)

# STU407D

## PACKAGE OUTLINE DIMENSIONS

TO-252-4L



REF .	Millimeters	
	MIN	MAX
A	6.40	6.80
B	5.2	5.50
C	6.80	10.20
D	2.20	3.00
P	1.27 REF.	
S	0.50	0.80
G	0.40	0.60
H	2.20	2.40
J	0.45	0.60
K	0	0.15
L	0.90	1.50
M	5.40	5.80

# STU407D

## TO-252-4L Tape and Reel Data

### TO-252-4L Carrier Tape

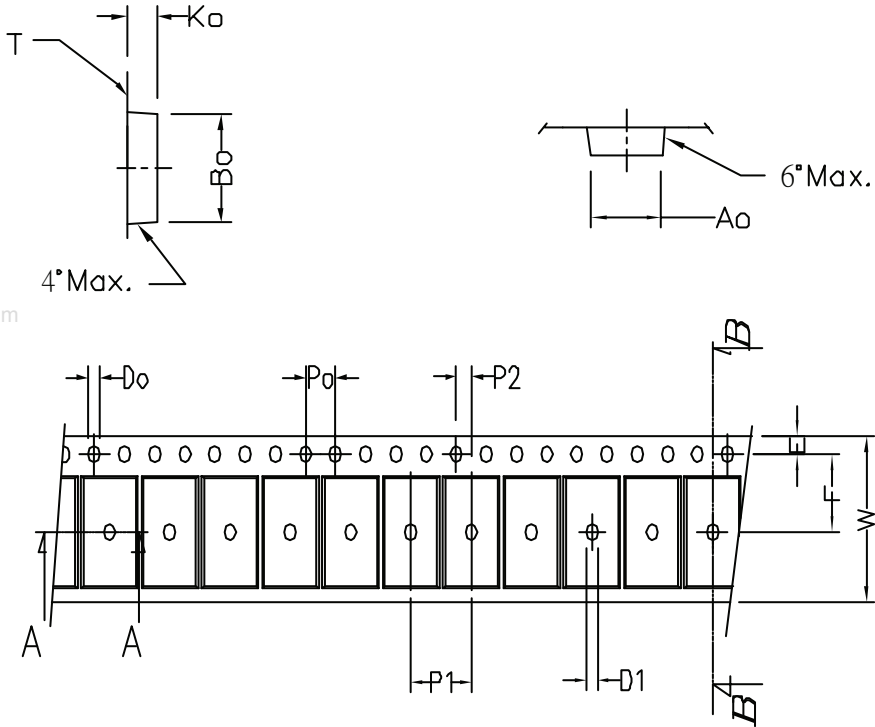

symbol	$A_0$	$B_0$	$K_0$	$P_0$	$P_1$	$P_2$	$T$
Spec	$6.96 \pm 0.1$	$10.49 \pm 0.1$	$2.79 \pm 0.1$	$4.0 \pm 0.1$	$8.0 \pm 0.10$	$2.0 \pm 0.05$	$0.33 \pm 0.013$
symbol	$E$	$F$	$D_0$	$D_1$	$W$	$10P_0$	
Spec	$1.75 \pm 0.1$	$7.5 \pm 0.05$	$1.55 \pm 0.05$	$1.5 \pm 0.25$	$16.0^{+0.3}_{-0.1}$	$40.0 \pm 0.2$	

### TO-252-4L Reel

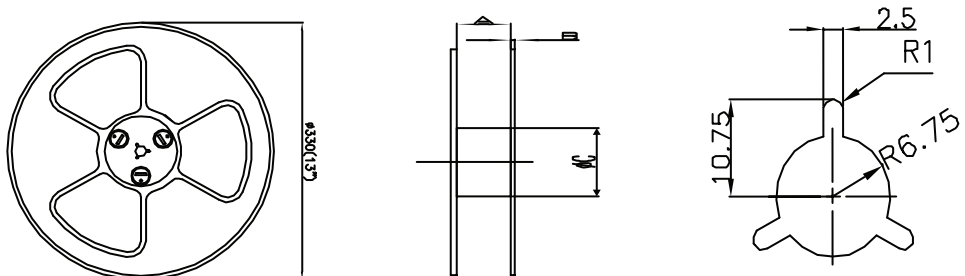

UNIT:mm

Width of carrier tape	8	12	16	24	32	44	56
$A \pm 0.1$	9.4	13.4	17.4	25.4	33.4	45.4	57.4
$B$	2.3	2.3	2.3	2.3	2.3	2.3	2.3
$\phi C$	100	100	100	100	100	100	100