



Micro Commercial Components

Micro Commercial Components  
 20736 Marilla Street Chatsworth  
 CA 91311  
 Phone: (818) 701-4933  
 Fax: (818) 701-4939

## Features

- Fast Switching Speed
- Surface Mount Package Ideally Suited for Automatic Insertion
- For General Purpose Switching Applications
- High Conductance

## Mechanical Data

- Case Material: Molded Plastic. UL Flammability Classification Rating 94V-0 and MSL Rating 1
- Polarity: See Diagram
- Marking: KA3

## Maximum Ratings @ 25°C Unless Otherwise Specified

Characteristic	Symbol	Value	Unit
Non-Repetitive Peak Reverse Volt.	$V_{RM}$	100	V
Peak Repetitive Reverse Voltage	$V_{RRM}$		
Working Peak Reverse Voltage	$V_{RWM}$	75	V
DC Blocking Voltage	$V_R$		
RMS Reverse Voltage	$V_{R(RMS)}$	53	V
Forward Continuous Current(Note1)	$I_{FM}$	500	mA
Average Rectified Output Current	$I_o$	250	mA
Non-Repetitive Peak @ $t \leq 1.0s$	$I_{FSM}$	2	A
Forward Surge Current @ $t = 1.0us$		4	A
Power Dissipation(Note 1)	$P_d$	350	mW
Thermal Resistance(Note 1)	$R$	357	K/W
Operation/Storage Temp. Range	$T_j, T_{STG}$	-55 to +150	°C

## Electrical Characteristics @ 25°C Unless Otherwise Specified

Charateristic	Symbol	Min	Max	Unit	Test Cond.	
Maximum Forward Voltage Drop	$V_{FM}$	----	0.62	0.72	V	$I_F = 5.0mA$
			0.855	1		$I_F = 10mA$
			1.25			$I_F = 100mA$
						$I_F = 150mA$
Maximum Peak Reverse Current	$I_{RM}$	----	2.5	uA	uA	$V_R = 75V$
			50	uA		$V_R = 75V T_j = 150^\circ C$
			30	uA		$V_R = 25V T_j = 150^\circ C$
			25	nA		$V_R = 20V$
Junction Capacitance	$C_j$	----	4	pF	$V_R = 0V, f = 1.0MHz$	
Reverse Recovery Time	$t_{rr}$	----	4	ns		

# MMBD4448

## Surface Mount Switching Diode 350mW

### SOT-23

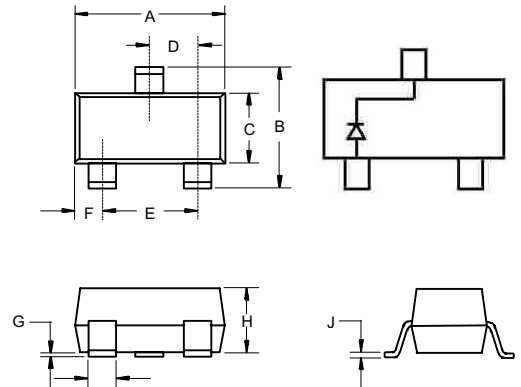

DIM	DIMENSIONS				NOTE
	INCHES		MM		
A	.110	.120	2.80	3.04	
B	.083	.098	2.10	2.64	
C	.047	.055	1.20	1.40	
D	.035	.041	.89	1.03	
E	.070	.081	1.78	2.05	
F	.018	.024	.45	.60	
G	.0005	.0039	.013	.100	
H	.035	.044	.89	1.12	
J	.003	.007	.085	.180	
K	.015	.020	.37	.51	

### Suggested Solder Pad Layout

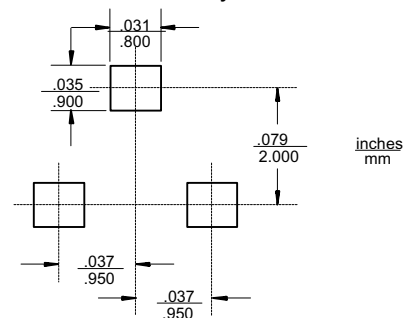

Note: 1. Valid provided that terminals are kept at ambient temperature  
 2.  $T_{rr}$  Test Condition:  $I_F = I_R = 10mA, I_{rr} = 0.1 * I_R, R = 100 OHM$

# MMBD4448

Figure 1  
Typical Forward Characteristics

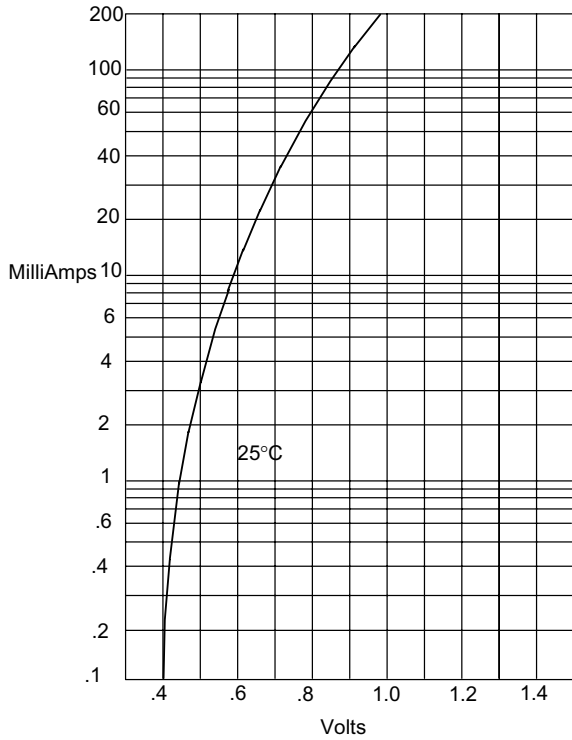

Instantaneous Forward Current - Amperes *versus*  
Instantaneous Forward Voltage - Volts

Figure 2  
Forward Derating Curve

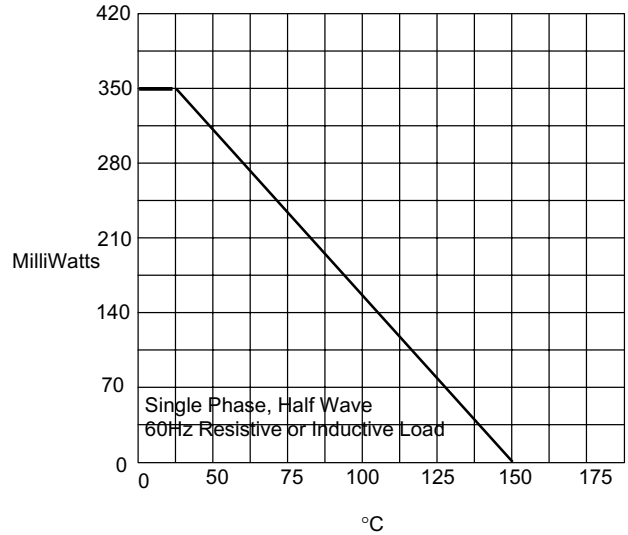

Admissible Power Dissipation - MilliWatts *versus*  
Ambient Temperature - °C

Figure 3  
Junction Capacitance

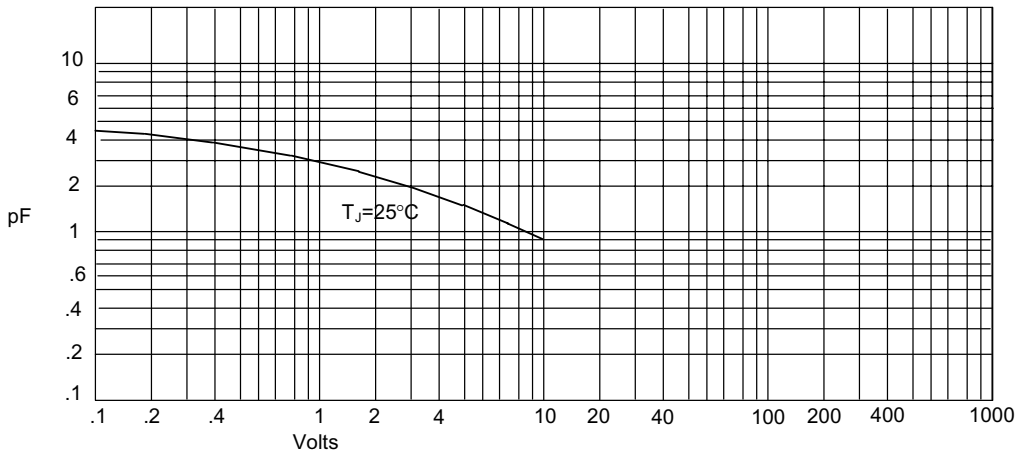

Junction Capacitance - pF *versus*  
Reverse Voltage - Volts

# MMBD4448



Micro Commercial Components

Figure 4  
Typical Reverse Characteristics

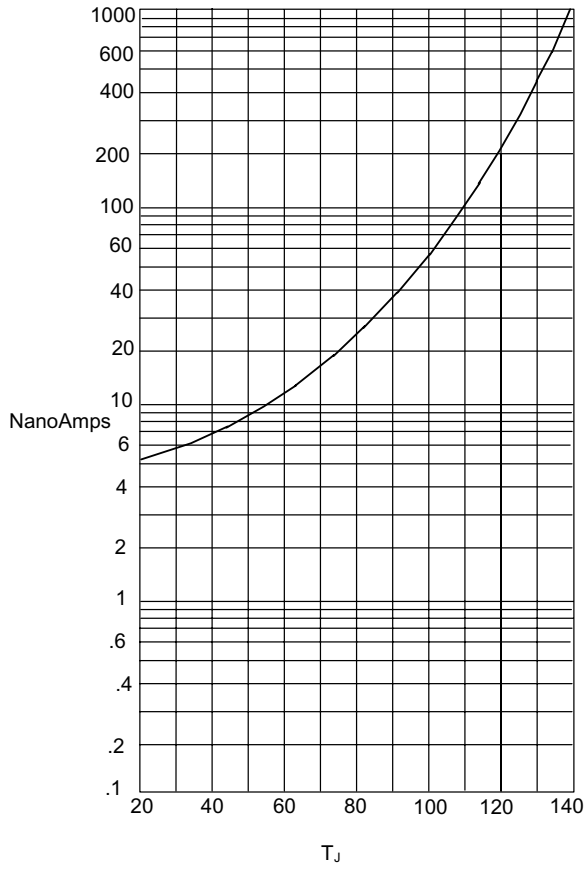

Instantaneous Reverse Leakage Current - NanoAmperes versus Junction Temperature - °C

T<sub>A</sub>=25°C

Figure 5  
Peak Forward Surge Current

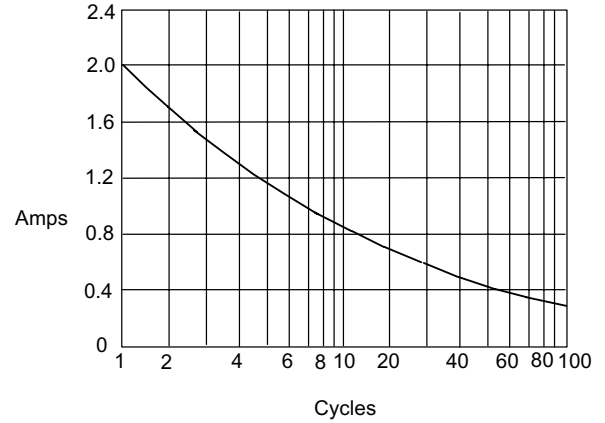

Peak Forward Surge Current - Amperes versus Number Of Cycles At 60Hz - Cycles



Micro Commercial Components

## Ordering Information

Device (Part Number)-TP	Packing Tape&Reel;3Kpcs/Reel
----------------------------	---------------------------------

**\*\*\*IMPORTANT NOTICE\*\*\***

*Micro Commercial Components Corp.* reserves the right to make changes without further notice to any product herein to make corrections, modifications, enhancements, improvements, or other changes. *Micro Commercial Components Corp.* does not assume any liability arising out of the application or use of any product described herein; neither does it convey any license under its patent rights, nor the rights of others. The user of products in such applications shall assume all risks of such use and will agree to hold *Micro Commercial Components Corp.* and all the companies whose products are represented on our website, harmless against all damages.

**\*\*\*APPLICATIONS DISCLAIMER\*\*\***

Products offer by *Micro Commercial Components Corp.* are not intended for use in Medical, Aerospace or Military Applications.