

Features

- Single Control CMOS Logic for Each Bit
- Attenuation: 1 dB Steps to 15 dB
- Low DC Power Consumption: 50 μ W
- Lead-Free TSSOP-16 Package
- 100% Matte Tin Plating over Copper
- Halogen-Free “Green” Mold Compound
- RoHS* Compliant and 260°C Reflow Compatible

Description

The M/A-COM MAATSS0019 is a 4 Bit, 1 dB step GaAs MMIC digital attenuator in a lead-free TSSOP-16 surface mount plastic package. The MAATSS0019 is ideally suited for use where high accuracy, very low power consumption and low intermodulation products are required. Typical applications include radio, cellular, wireless LANs, GPS equipment and other gain / level control circuits.

The MAATSS0019 is fabricated using a mature 1 micron GaAs MESFET process. The process features full chip passivation for increased performance and reliability.

Functional Schematic ^{3,4}

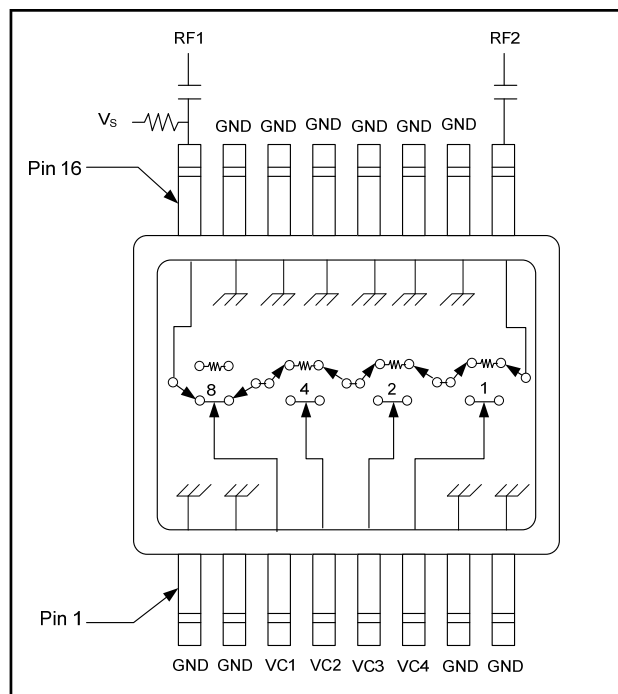

3. Required external blocking caps shown.
4. VS can be applied at RF1 or RF2 using a 10K Ω or greater pull-up resistor.

Ordering Information ^{1,2}

Part Number	Package
MAATSS0019	Bulk Packaging
MAATSS0019TR	1000 piece reel
MAATSS0019SMB	Sample Board

1. Reference Application Note M513 for reel size information.
2. All sample boards include 5 loose parts.

Pin Configuration

Pin No.	Function	Pin No.	Function
1	Ground	9	RF Port 2
2	Ground	10	Ground
3	VC1	11	Ground
4	VC2	12	Ground
5	VC3	13	Ground
6	VC4	14	Ground
7	Ground	15	Ground
8	Ground	16	RF Port 1

* Restrictions on Hazardous Substances, European Union Directive 2002/95/EC.

Electrical Specifications: $T_A = 25^\circ\text{C}$

Parameter	Test Conditions	Units	Min.	Typ.	Max.
Reference Insertion Loss	0.5 - 1.0 GHz	dB	—	1.3	1.6
	1.0 - 2.0 GHz	dB	—	1.6	—
	2.0 - 3.0 GHz	dB	—	1.8	—
	3.0 - 4.0 GHz	dB	—	2.5	—
Attenuation Accuracy	0.5 - 1.0 GHz 1.0 - 2.0 GHz 2.0 - 4.0 GHz	$\pm (0.25 \text{ dB} + 5\% \text{ of Atten. setting in dB}) \text{ dB}$ $\pm (0.4 \text{ dB} + 5\% \text{ of Atten. setting in dB}) \text{ dB Typical}$ $\pm (0.6 \text{ dB} + 5\% \text{ of Atten. setting in dB}) \text{ dB Typical}$			
VSWR	0.5 - 2.0 GHz 2.0 - 4.0 GHz	Ratio Ratio	— —	1.3:1 1.3:1	— —
Trise, Tfall	—	μS	—	2.5	—
Ton, Toff	—	μS	—	1.0	—
Input P1dB	> 0.5 GHz	dBm	—	24	—
IP ₂	Measured Relative to Input Power, Two Tone input up to 5 dBm, 5 MHz Spacing > 0.5 GHz	dBm	—	80	—
IP ₃	Measured Relative to Input Power, Two Tone input up to 5 dBm, 5 MHz Spacing > 0.5 GHz	dBm	—	47	—

Absolute Maximum Ratings ^{5,6}

Parameter	Absolute Maximum
Input Power 50 MHz 500 - 4000 MHz	+27 dBm +34 dBm
Control Voltage	+8 V, -1.0 V
Operating Temperature	-40°C to +85°C
Storage Temperature	-65°C to +150°C

- Exceeding any one or combination of these limits may cause permanent damage to this device.
- M/A-COM does not recommend sustained operation near these survivability limits.

Truth Table ^{7,8}

VC1	VC2	VC3	VC4	Attenuation (dB)
1	1	1	1	Reference IL
1	1	1	0	1
1	1	0	1	2
1	0	1	1	4
0	1	1	1	8
0	0	0	0	15

- 0 = $0 \pm 0.2 \text{ V}$, 1 = +5 V @ 50 μA max. current total.
- VS = +5 V.

Handling Procedures

Please observe the following precautions to avoid damage:

Static Sensitivity

Gallium Arsenide Integrated Circuits are sensitive to electrostatic discharge (ESD) and can be damaged by static electricity. Proper ESD control techniques should be used when handling these devices.

Typical Performance Curves

Relative Attenuation

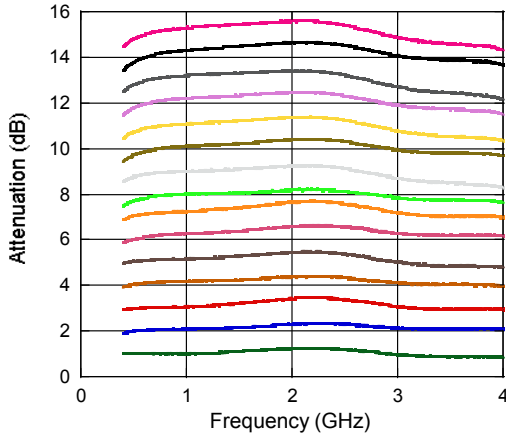

Insertion Loss

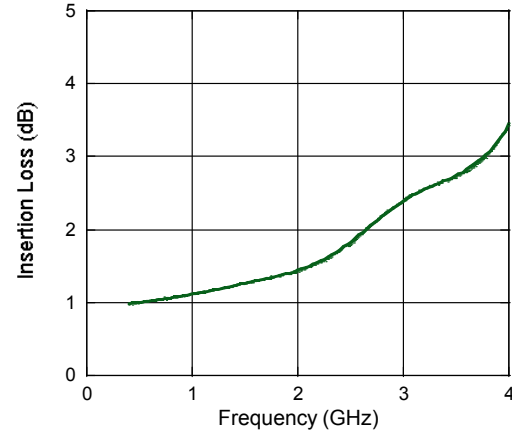

Input Return Loss

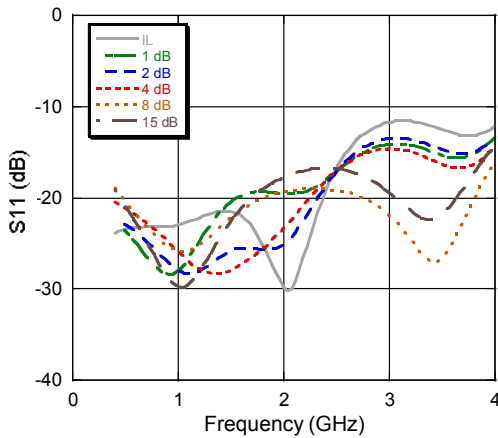

Output Return Loss

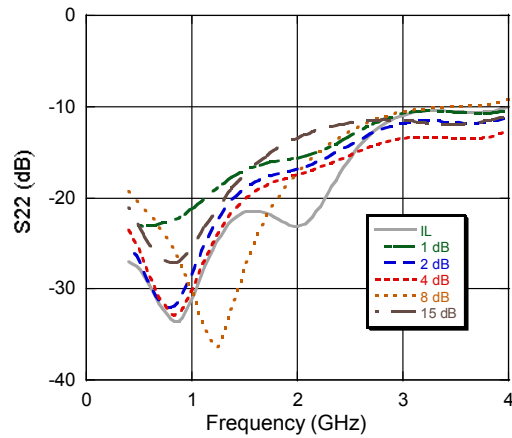

Attenuation Accuracy

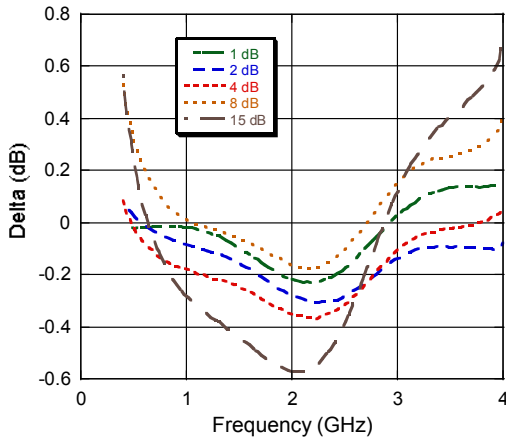

Input IP3

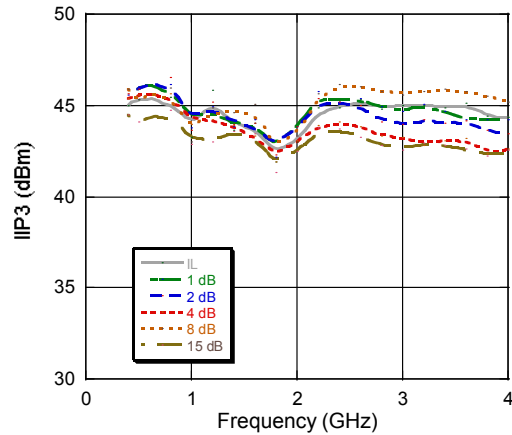

Lead Free TSSOP-16[†]

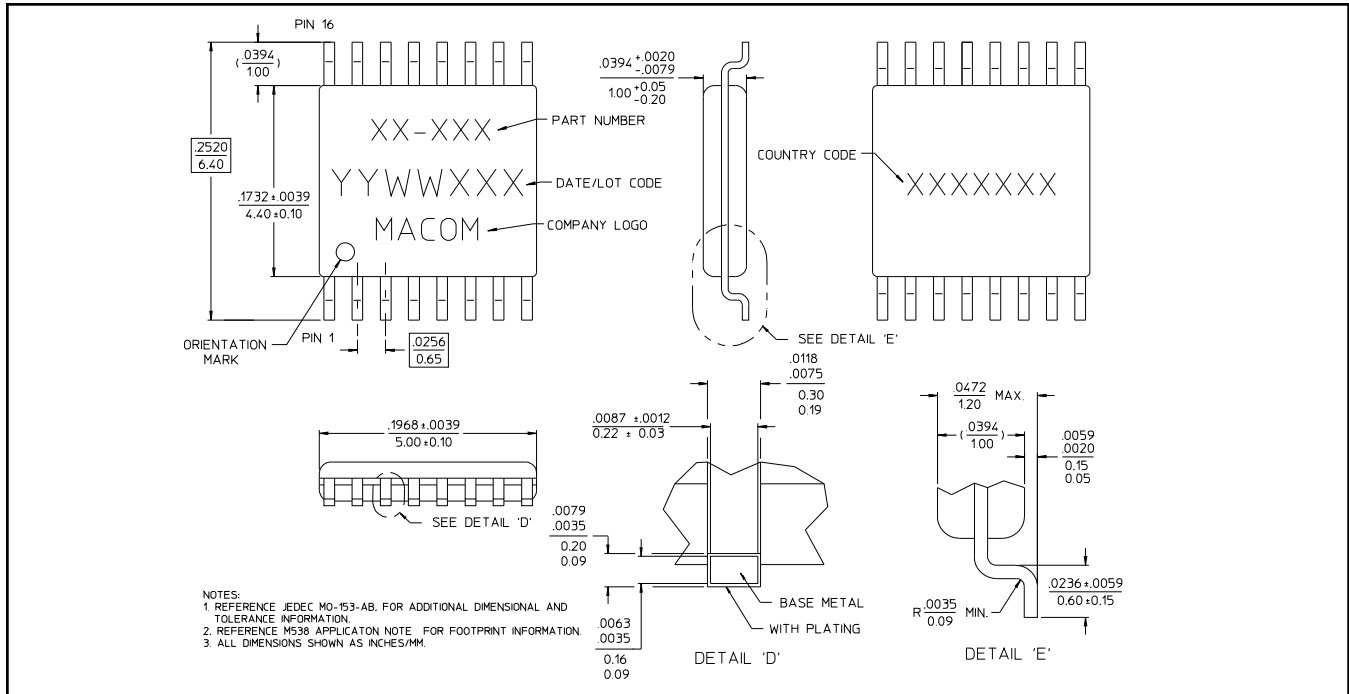

[†] Reference Application Note M538 for lead-free solder reflow recommendations.
Meets JEDEC moisture sensitivity level 1 requirements.