

VTT PHOTOTRANSISTORS

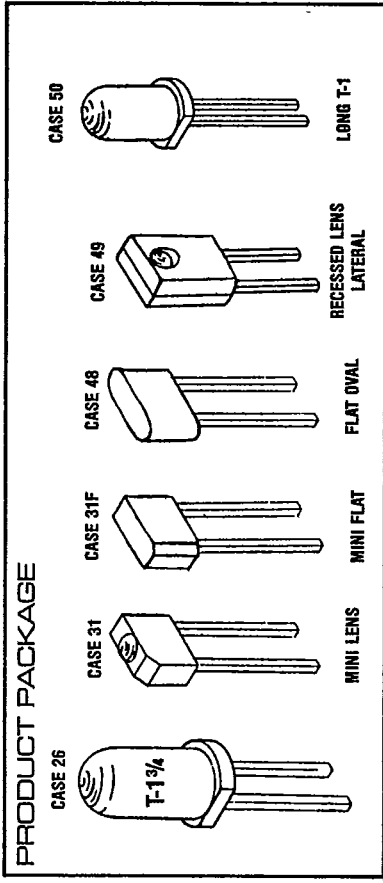

ELECTRO-OPTICAL CHARACTERISTICS (at 25°C)

PART NO.	CHIP TYPE	Light ⁽¹⁾ Current		Dark Current	Collector Breakdown	Emitter Breakdown	Saturation Voltage	Rise/Fall Time	Angle ⁽²⁾	CASE STYLE	CASE NO.
		I _c mA	H _v V								
VT11012	50T	0.2	100	25	50	60	0.40	3	31°	TO-18	1
VT11010	50T	1.0	100	25	30	60	0.40	5		TO-18	1
VT11011	50T	1.0	100	25	30	60	0.40	5		TO-18	1
VT11013	50T	2.5	100	25	20	40	0.40	8		TO-18	1
VT11020	25T	0.75	100	10	50	60	0.25	1.5		TO-18	1
VT11021	25T	0.15	0.35	100	10	20	0.25	2		TO-18	1
VT11022	25T	0.30	0.75	100	10	20	0.25	3		TO-18	1
VT11023	25T	0.60	—	100	10	30	0.25	4		TO-18	1
VT11031	60T	1.0	100	100	10	40	0.40	5		TO-18	2
VT11032	60T	4.0	100	100	10	40	0.40	10		TO-18	2
VT11033	60T	8.0	100	100	10	40	0.40	15		TO-18	2
VT11110	50T	1.0	30	100	50	20	0.40	3		TO-18	3
VT11111	50T	2.0	60	100	50	20	0.40	5		TO-18	3
VT11112	50T	4.0	100	100	50	20	0.40	8		TO-18	3
VT11113	50T	8.0	100	100	50	20	0.40	15		TO-18	3
VT11114	50T	15.0	100	100	50	20	0.40	30		TO-18	3
VT11120	25T	0.35	0.75	100	10	20	0.25	2		TO-18	3
VT11121	25T	0.65	1.50	100	10	20	0.25	3		TO-18	3
VT11122	25T	1.25	3.50	100	10	20	0.25	4		TO-18	3
VT11123	25T	3.0	—	100	10	30	0.25	4		TO-18	3
VT11131	60T	1.0	30	100	10	40	0.40	5		TO-18	3
VT11132	60T	4.0	20	50	100	10	0.40	10		TO-18	3
VT11133	60T	8.0	20	50	100	10	0.40	15		TO-18	3
VT11211	40T	1.3	20	50	100	10	0.25	3		TO-18	26
VT11212	40T	2.0	20	50	100	10	0.25	4		TO-18	26
VT11213	40T	2.7	20	50	100	10	0.25	5		TO-18	26
VT11214	40T	4.0	20	50	100	10	0.25	6		TO-18	26
VT11221	25T	4.0	100	50	100	10	0.25	1.5		TO-18	26
VT11222	25T	8.0	100	50	100	10	0.25	2		TO-18	26
VT11223	25T	16.0	100	50	100	10	0.25	3		TO-18	26
VT11224	25T	32.0	100	50	100	10	0.25	4		TO-18	26
VT11225	25T	64.0	100	50	100	10	0.25	5		TO-18	26
VT11226	25T	128.0	100	50	100	10	0.25	6		TO-18	26
VT11227	25T	256.0	100	50	100	10	0.25	7		TO-18	26
VT11228	25T	512.0	100	50	100	10	0.25	8		TO-18	26
VT11229	25T	1024.0	100	50	100	10	0.25	9		TO-18	26
VT11230	25T	2048.0	100	50	100	10	0.25	10		TO-18	26

VTTA-3B

PHOTOTRANSISTORS
PHOTODARLINGTONS
CHIPS
MATCHED LED-TRANSISTORS



10900 PAGE BLVD. ST. LOUIS, MO. 63132 USA PHONE 314-423-4900 TWX 910-764-0811

PRODUCT DESCRIPTION
This series of phototransistors and photodarlington consists of six standard chips in 16 different cases to provide a broad range of devices and characteristics. End viewing and side viewing (lateral) devices are included. All chips are planar, epitaxial, fully passivated silicon NPN devices and are available for customer mounting.
A series of matched GaAs LED-phototransistors and photodarlington providing guaranteed minimum characteristics are listed in this bulletin.

ABSOLUTE MAXIMUM RATINGS

PARAMETER	SYMBOL	TO-18	COAX	CERAMIC	MOLDED	UNITS
MAXIMUM CONTINUOUS POWER DISSIPATION (Derate above 25°C)	P _c	250	50	100	50	mW
MAXIMUM CURRENT LED (Derate above 25°C)	I _f	2.5	0.5	1.67	0.67	mA/C
25A/25T CHIP	I _f	—	—	—	50	mA
40T CHIP	I _f	—	—	25	25	mA
50A/50T CHIP	I _f	—	—	50	25	mA
60T CHIP	I _f	—	—	—	—	mA
OPERATING TEMPERATURE RANGE	T _o , T _c	+125	+125	+70	+85	C
STORAGE TEMPERATURE RANGE	T _o , T _c	-65	-65	-55	-40	+100
LEAD SOLDERING TEMP (1/6 mm from case, 5 Sec Max)		260	260	260	230	C

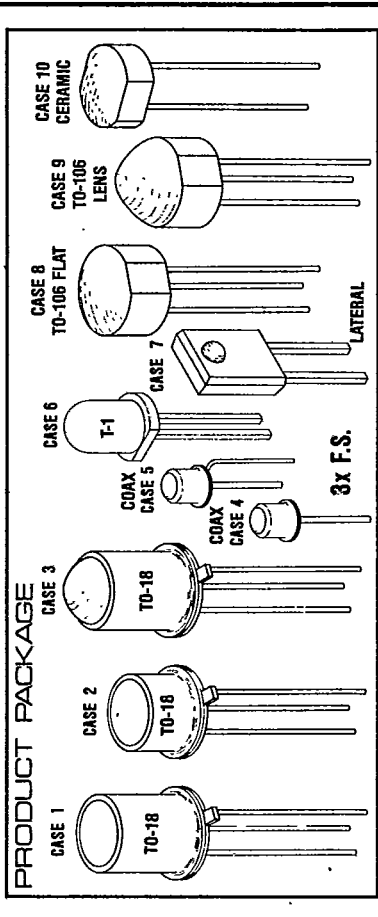

VTT PHOTOTRANSISTORS

ELECTRO-OPTICAL CHARACTERISTICS (at 25°C)

PART NO. CHIP TYPE	Light ⁽¹⁾ Current		Dark Current I _{CO}	Collector Breakdown V _{CECO} I _C =100 μA H=0	Emitter Breakdown V _{BECEO} I _E =100 μA H=0	Saturation Voltage V _{CE(sat)} I _E =1.0 mA H=400 I _C	Rise/Fall Time t _r , t _f I _E =1.0 mA R _L =100	Ang. ⁽²⁾ Resp. θ	CASE STYLE	CASE NO.								
	mA	mm									Condition	H	V _{CE}	V _{CE}	V _{CE}	V _{CE}	V _{CE}	V _{CE}
PHOTOTRANSISTOR																		
VTT3821	0.03	20	10	30	5.0	0.25	1.5	20°	MINI LENS	31								
VTT3822	0.08	20	100	30	5.0	0.25	2											
VTT3823	0.18	20	100	30	5.0	0.25	3											
VTT3825	0.42	20	5.0	100	10	0.25	4											
VTT3825	0.72	20	5.0	100	10	0.25	5											
VTT3821F	0.06	20	5.0	100	10	0.25	1.5	60°	MINI FLAT	31F								
VTT3822F	0.12	20	5.0	100	10	0.25	2											
VTT3823F	0.24	20	5.0	100	10	0.25	3											
VTT3821	0.05	20	5.0	100	10	0.25	1.5	60°	CLEAR EPOXY MINI LENS	48								
VTT3822	0.10	20	5.0	100	10	0.25	2											
VTT3823	0.20	20	5.0	100	10	0.25	3											
VTT3821	0.03	20	5.0	100	10	0.25	1.5	60°	MINI FLAT	7								
VTT3822	0.06	20	5.0	100	10	0.25	2											
VTT3823	0.12	20	5.0	100	10	0.25	3											
VTT3821	0.5	100	5.0	100	10	0.40	4	30°	MINI FLAT									
VTT3822	1.0	100	5.0	100	10	0.40	5											
VTT3823	2.0	100	5.0	100	10	0.40	6											
VTT3821	0.5	100	5.0	100	10	0.25	1.5	30°	MINI FLAT									
VTT3822	1.0	100	5.0	100	10	0.25	2											
VTT3823	2.0	100	5.0	100	10	0.25	3											
VTT3821	0.5	100	5.0	100	10	0.25	1.5	30°	MINI FLAT									
VTT3822	1.0	100	5.0	100	10	0.25	2											
VTT3823	2.0	100	5.0	100	10	0.25	3											
VTT3821	0.5	100	5.0	100	10	0.25	1.5	30°	MINI FLAT									
VTT3822	1.0	100	5.0	100	10	0.25	2											
VTT3823	2.0	100	5.0	100	10	0.25	3											
VTT3821	0.5	100	5.0	100	10	0.25	1.5	30°	MINI FLAT									
VTT3822	1.0	100	5.0	100	10	0.25	2											
VTT3823	2.0	100	5.0	100	10	0.25	3											
VTT3821	0.5	100	5.0	100	10	0.25	1.5	30°	MINI FLAT									
VTT3822	1.0	100	5.0	100	10	0.25	2											
VTT3823	2.0	100	5.0	100	10	0.25	3											
VTT3821	0.5	100	5.0	100	10	0.25	1.5	30°	MINI FLAT									
VTT3822	1.0	100	5.0	100	10	0.25	2											
VTT3823	2.0	100	5.0	100	10	0.25	3											
VTT3821	0.5	100	5.0	100	10	0.25	1.5	30°	MINI FLAT									
VTT3822	1.0	100	5.0	100	10	0.25	2											
VTT3823	2.0	100	5.0	100	10	0.25	3											
VTT3821	0.5	100	5.0	100	10	0.25	1.5	30°	MINI FLAT									
VTT3822	1.0	100	5.0	100	10	0.25	2											
VTT3823	2.0	100	5.0	100	10	0.25	3											
VTT3821	0.5	100	5.0	100	10	0.25	1.5	30°	MINI FLAT									
VTT3822	1.0	100	5.0	100	10	0.25	2											
VTT3823	2.0	100	5.0	100	10	0.25	3											
VTT3821	0.5	100	5.0	100	10	0.25	1.5	30°	MINI FLAT									
VTT3822	1.0	100	5.0	100	10	0.25	2											
VTT3823	2.0	100	5.0	100	10	0.25	3											
VTT3821	0.5	100	5.0	100	10	0.25	1.5	30°	MINI FLAT									
VTT3822	1.0	100	5.0	100	10	0.25	2											
VTT3823	2.0	100	5.0	100	10	0.25	3											
VTT3821	0.5	100	5.0	100	10	0.25	1.5	30°	MINI FLAT									
VTT3822	1.0	100	5.0	100	10	0.25	2											
VTT3823	2.0	100	5.0	100	10	0.25	3											
VTT3821	0.5	100	5.0	100	10	0.25	1.5	30°	MINI FLAT									
VTT3822	1.0	100	5.0	100	10	0.25	2											
VTT3823	2.0	100	5.0	100	10	0.25	3											
VTT3821	0.5	100	5.0	100	10	0.25	1.5	30°	MINI FLAT									
VTT3822	1.0	100	5.0	100	10	0.25	2											
VTT3823	2.0	100	5.0	100	10	0.25	3											
VTT3821	0.5	100	5.0	100	10	0.25	1.5	30°	MINI FLAT									
VTT3822	1.0	100	5.0	100	10	0.25	2											
VTT3823	2.0	100	5.0	100	10	0.25	3											
VTT3821	0.5	100	5.0	100	10	0.25	1.5	30°	MINI FLAT									
VTT3822	1.0	100	5.0	100	10	0.25	2											
VTT3823	2.0	100	5.0	100	10	0.25	3											
VTT3821	0.5	100	5.0	100	10	0.25	1.5	30°	MINI FLAT									
VTT3822	1.0	100	5.0	100	10	0.25	2											
VTT3823	2.0	100	5.0	100	10	0.25	3											
VTT3821	0.5	100	5.0	100	10	0.25	1.5	30°	MINI FLAT									
VTT3822	1.0	100	5.0	100	10	0.25	2											
VTT3823	2.0	100	5.0	100	10	0.25	3											
VTT3821	0.5	100	5.0	100	10	0.25	1.5	30°	MINI FLAT									
VTT3822	1.0	100	5.0	100	10	0.25	2											
VTT3823	2.0	100	5.0	100	10	0.25	3											
VTT3821	0.5	100	5.0	100	10	0.25	1.5	30°	MINI FLAT									
VTT3822	1.0	100	5.0	100	10	0.25	2											
VTT3823	2.0	100	5.0	100	10	0.25	3											
VTT3821	0.5	100	5.0	100	10	0.25	1.5	30°	MINI FLAT									
VTT3822	1.0	100	5.0	100	10	0.25	2											
VTT3823	2.0	100	5.0	100	10	0.25	3											
VTT3821	0.5	100	5.0	100	10	0.25	1.5	30°	MINI FLAT									
VTT3822	1.0	100	5.0	100	10	0.25	2											
VTT3823	2.0	100	5.0	100	10	0.25	3											
VTT3821	0.5	100	5.0	100	10	0.25	1.5	30°	MINI FLAT									
VTT3822	1.0	100	5.0	100	10	0.25	2											
VTT3823	2.0	100	5.0	100	10	0.25	3											
VTT3821	0.5	100	5.0	100	10	0.25	1.5	30°	MINI FLAT									
VTT3822	1.0	100	5.0	100	10	0.25	2											
VTT3823	2.0	100	5.0	100	10	0.25	3											
VTT3821	0.5	100	5.0	100	10	0.25	1.5	30°	MINI FLAT									
VTT3822	1.0	100	5.0	100	10	0.25	2											
VTT3823	2.0	100	5.0	100	10	0.25	3											
VTT3821	0.5	100	5.0	100	10	0.25	1.5	30°	MINI FLAT									
VTT3822	1.0	100	5.0	100	10	0.25	2											
VTT3823	2.0	100	5.0	100	10	0.25	3											
VTT3821	0.5	100	5.0	100	10	0.25	1.5	30°	MINI FLAT									
VTT3822	1.0	100	5.0	100	10	0.25	2											
VTT3823	2.0	100	5.0	100	10	0.25	3											
VTT3821	0.5	100	5.0	100	10	0.25	1.5	30°	MINI FLAT									
VTT3822	1.0	100	5.0	100	10	0.25	2											
VTT3823	2.0	100	5.0	100	10	0.25	3											
VTT3821	0.5	100	5.0	100	10	0.25	1.5	30°	MINI FLAT									
VTT3822	1.0	100	5.0	100	10	0.25	2											
VTT3823	2.0	100	5.0	100	10	0.25	3											
VTT3821	0.5	100	5.0	100	10	0.25	1.5	30°	MINI FLAT									
VTT3822	1.0	100	5.0	100	10	0.25	2											
VTT3823	2.0	100	5.0	100	10	0.25	3											
VTT3821	0.5	100	5.0	100	10	0.25	1.5	30°	MINI FLAT									
VTT3822	1.0	100	5.0	100	10	0.25	2											
VTT3823	2.0	100	5.0	100	10	0.25	3											
VTT3821	0.5	100	5.0	100	10	0.25	1.5	30°	MINI FLAT									
VTT3822	1.0	100	5.0	100	10	0.25	2											
VTT3823	2.0	100	5.0	100	10	0.25	3											
VTT3821	0.5	100	5.0	100	10	0.25	1.5	30°	MINI FLAT									
VTT3822	1.0	100	5.0	100	10	0.25	2											
VTT3823	2.0	100	5.0	100	10	0.25	3											
VTT3821	0.5	100	5.0	100	10	0.25	1.5	30°	MINI FLAT									
VTT3822	1.0	100	5.0	100	10	0.25												

VTA PHOTODARLINGTONS

ELECTRO-OPTICAL CHARACTERISTICS (at 25°C)

PART NO.	CHIP TYPE	Light ⁽¹⁾ Current		Dark Current	Collector Breakdown Voltage	Emitter Breakdown Voltage	Saturation Voltage	Rise/Fall Time	Angle Resp.	CASE STYLE	CASE NO.
		mA	Condition								
VTA1011	50A	1	40	100	50	60	1.5	60	31°	TO-18	1
VTA1012	50A	3	10	500	10	60	1.5	60			
VTA1013	50A	8	4.0	1000	10	60	1.5	250			
VTA1021	25A	0.25	1.0	200	10	60	1.5	30			
VTA1022	25A	0.75	2.0	400	10	60	1.5	60			
VTA1023	25A	2.0	4.0	500	10	60	1.5	150			
VTA1111	50A	1	20.0	100	30	60	1.5	100	11°	TO-18	3
VTA1112	50A	15	4.0	50	10	60	1.5	250			
VTA1121	25A	1.0	5.0	40	10	60	1.5	60	1°	DMK	4
VTA1122	25A	1.0	5.0	40	10	60	1.5	50			
VTA3121	25A	4.0	4.0	50	10	60	1.5	150			
VTA3122	25A	4.0	4.0	50	10	60	1.5	150			
VTA3123	25A	4.0	4.0	50	10	60	1.5	150			
VTA3221	25A	1.0	5.0	40	10	60	1.5	50	21°	DMK	5
VTA3222	25A	1.0	5.0	40	10	60	1.5	50			
VTA7121	25A	0.4	4.0	50	10	60	1.5	30	21°	MOLDED CLEAR EPOXY LENS	7
VTA7122	25A	0.4	4.0	50	10	60	1.5	30			
VTA7123	25A	1.6	4.0	50	10	60	1.5	150			
VTA9311	50A	1	4.0	50	10	60	1.5	60	15°	DMK	10
VTA9312	50A	3	10.0	40	10	60	1.5	120			
VTA9313	50A	8	4.0	50	10	60	1.5	250			
VTA9321	25A	0.25	1.0	40	10	60	1.5	30	11°	CERAMIC EPDM LENS	10
VTA9322	25A	0.75	2.5	40	10	60	1.5	60			
VTA9323	25A	2.0	4.0	50	10	60	1.5	150			

PHOTODARLINGTON

DARK CURRENT VS TEMPERATURE PHOTODARLINGTON

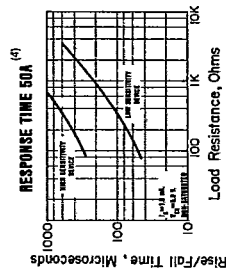
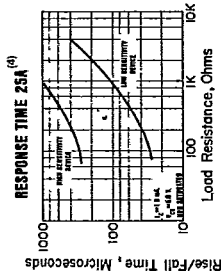
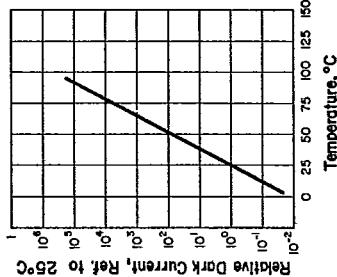

VTT PHOTOTRANSISTORS

ELECTRO-OPTICAL CHARACTERISTICS (at 25°C)

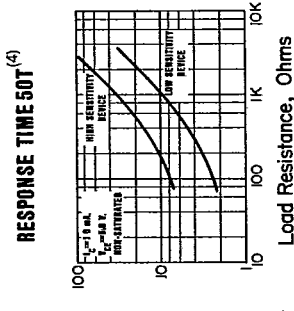
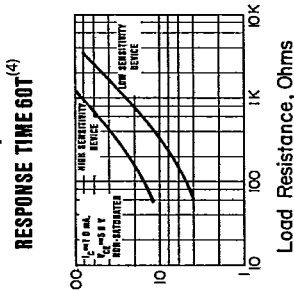
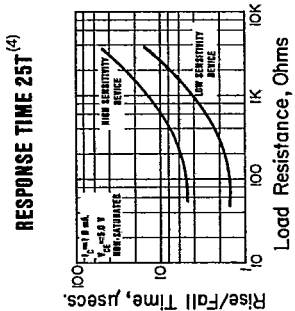
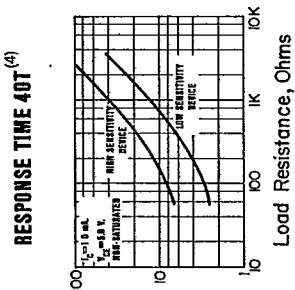

PHOTOTRANSISTOR AND PHOTODARLINGTON RELATIVE SPECTRAL RESPONSE

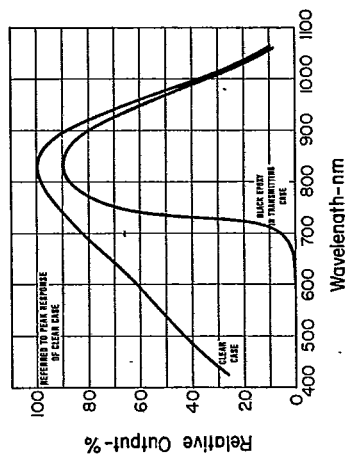

PHOTOTRANSISTOR DARK CURRENT VS TEMPERATURE

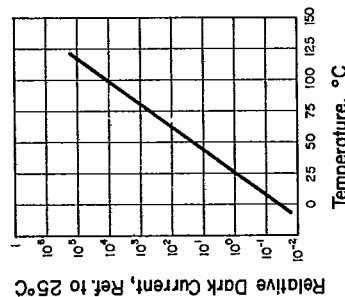

VTA-C/VTT-C CHIPS

ELECTRO-OPTICAL CHARACTERISTICS (at 25°C)

PART NO	D.C. Current Gain		Dark Current H=0 $V_{ce}=10V, I_c=0$ nA, max	Collector Breakdown V_{RECO} $I_c=100 \mu A$ Volts min	Emitter Breakdown V_{RECO} $I_e=100 \mu A$ Volts min	Saturation Voltage V_{CESAT} $I_c=1.0 mA$ $I_e=50 \mu A$ Volts, max	Rise/Fall Time t_r, t_f nsec, typ	Collector-Base ⁹⁾ Sensitivity S_{RCBO} (typ) $V_{ce}=5.0 V$
	β_{min}	β_{typ}						
VTA-C25	10K	50K	0.02	5.0	200	1.5	100	8
VTA-C50	5K	35K	0.24	5.0	100	1.5	150	53
VTT-C25	251	250	500	1.3	100	0.25	3	14
VTT-C40	407	150	550	4.0	100	0.4	4	35
VTT-C50	507	200	350	6.0	100	0.4	3	17
VTT-C60	607	200	500	10.0	100	0.4	3	17

CHIPS

CHIP TYPE	I_c (typ)	V_{ce} (min)	I_e (max)	Volts	min	Volts, max	t_r, t_f (nsec, typ)	nA/TC	S_{RCBO} (nA/(uW/cm ²))
VTA-C25	25A	10K	50K	0.02	5.0	200	1.5	100	8
VTA-C50	50A	5K	35K	0.24	5.0	100	1.5	150	53
VTT-C25	25T	250	250	500	1.3	100	0.25	3	14
VTT-C40	40T	150	150	550	4.0	100	0.4	4	35
VTT-C50	50T	200	200	350	6.0	100	0.4	3	17
VTT-C60	60T	200	500	10.0	10.0	100	0.4	3	17

PHOTOTRANSISTOR mm (inch)

60T

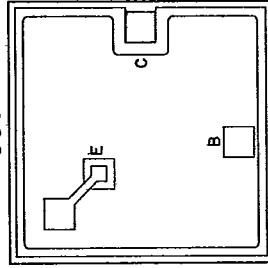

50T

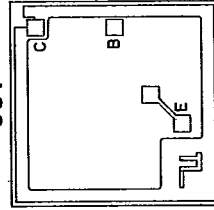

40T

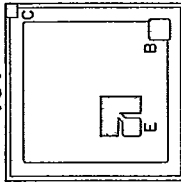

25T

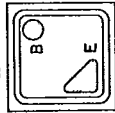

PHOTODARLINGTON

50A

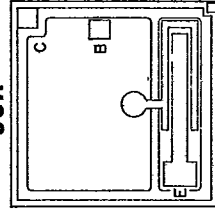

25A

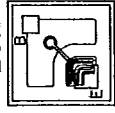

VTM MATCHED SETS

ELECTRO-OPTICAL CHARACTERISTICS (at 25°C)

PART NO.	Light Current		Dark ⁷⁾ Current I_{CO} nA, max	Collector Breakdown V_{RECO} $I_c=100 \mu A$ Volts, min	Emitter Breakdown V_{RECO} $I_e=100 \mu A$ Volts, min	Saturation Voltage V_{CESAT} Volts, max	Rise/Fall Time t_r, t_f nsec, typ	LED Forward Voltage V_f Volts, max	OUTPUT DEVICE
	I_c	Condition							
VTM 3321	10	5.0	100	30	50	1.0	0.25	2.0	PHOTOTRANSISTOR
VTM 3322	3.0	3.0	100	30	50	1.0	0.25	3.0	PHOTODARLINGTON
VTM 7121	0.5	5.0	100	30	50	0.4	0.25	3.0	PHOTOTRANSISTOR
VTM 7122	1.0	20	50	30	50	0.4	0.25	2.0	PHOTODARLINGTON
VTM 7123	2.0	20	50	30	50	0.6	1.8	2.0	PHOTOTRANSISTOR
VTM 7124	0.5	20	50	30	50	1.0	0.25	2.0	PHOTODARLINGTON
VTM 7125	0.5	20	50	30	50	1.0	0.25	2.0	PHOTODARLINGTON

MATCHED LED - PHOTOTRANSISTOR/LED - PHOTODARLINGTON

Each matched set consists of a discrete GaAs infrared emitting diode (IRED) and a discrete silicon phototransistor (photodarlington).

LED FWD VOLTAGE DROP

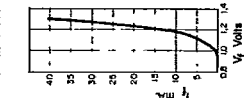

LED/PHOTOTRANSISTOR OUTPUT CURRENT VS TEMPERATURE

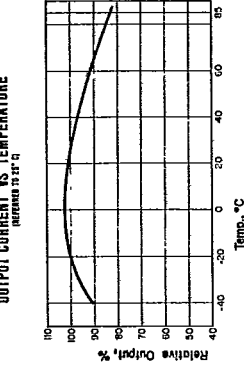

LED/PHOTODARLINGTON OUTPUT CURRENT VS TEMPERATURE

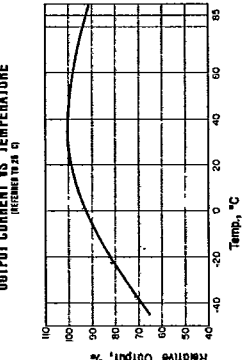

LED/PHOTOTRANSISTOR RELATIVE OUTPUT VS DISTANCE

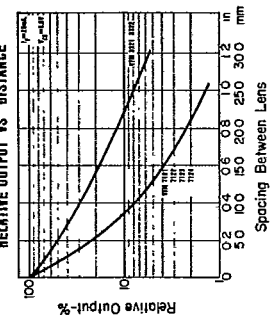

LED/PHOTODARLINGTON RELATIVE OUTPUT VS INPUT CURRENT

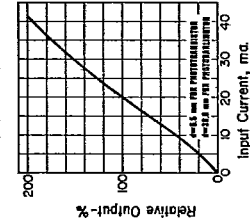

LED/PHOTODARLINGTON RELATIVE OUTPUT VS DISTANCE

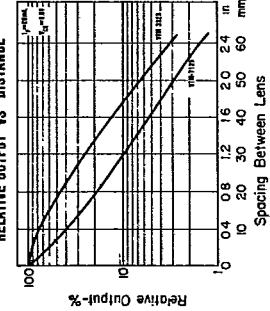

EG&G VACTEC

EG&G VACTEC

ELECTRO-OPTICAL CHARACTERISTICS (at 25°C)

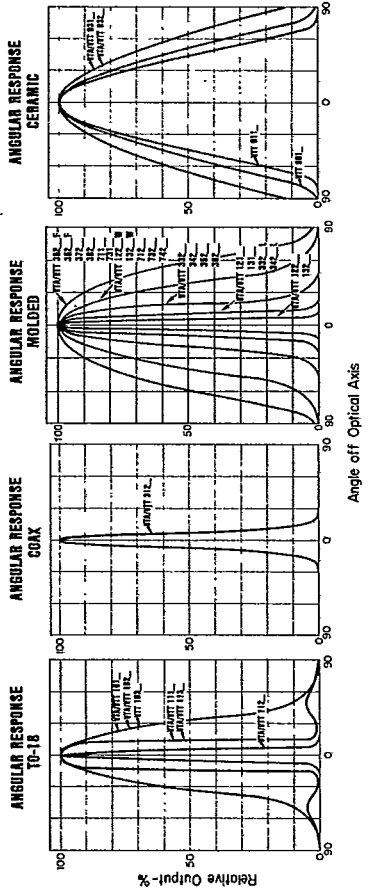

NOTES

1. Light source is a tungsten incandescent lamp operating at 2850 K, 1.00 fc from this source is a nominal 5mW/cm² (1 mW/cm² = 19.2 fc @ 2850 K).
2. Angular response is the angle between the optical axis and the angle for which the response is 50%.
3. On a 3 terminal device, the base terminal is connected. All specifications are with zero base current (I_b).
4. Response time curves show typical characteristics for devices having the lowest and highest light current in any series. (Example) VTT 1020 (lowest sensitivity) and VTT 1023 (highest sensitivity). Interpolate curves for intermediate sensitivity devices.
5. I_f is LED forward current.
6. d is the lens to lens spacing between the LED and detector.
7. I_f = 0.
8. H = 0 for all chip tests.
9. I_c = S_{RCBO} x I_c x Beta. Beta is base drive dependent and therefore is a function of light level. At base drive lower than that specified, the Beta falls off somewhat, and is higher at greater base drives.
10. E, B and C are bond pads for Emitter, Base and Collector. Chips are supplied with nickel or gold over nickel backside for silver epoxy die attach only. The collector connection should be made through the backside.
11. Chips are supplied in bulk form in vials or in chip trays. Quality is verified by a sampling plan. Selected chips from a vial are mounted on a TO-18 header, sealed and tested to the specification.

PACKAGE DIMENSIONS (mm) (inch)

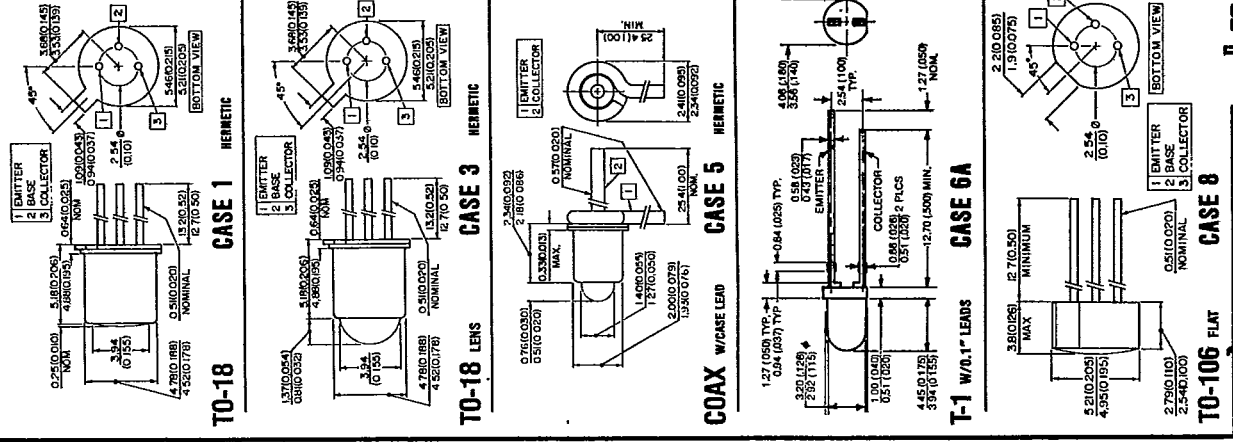

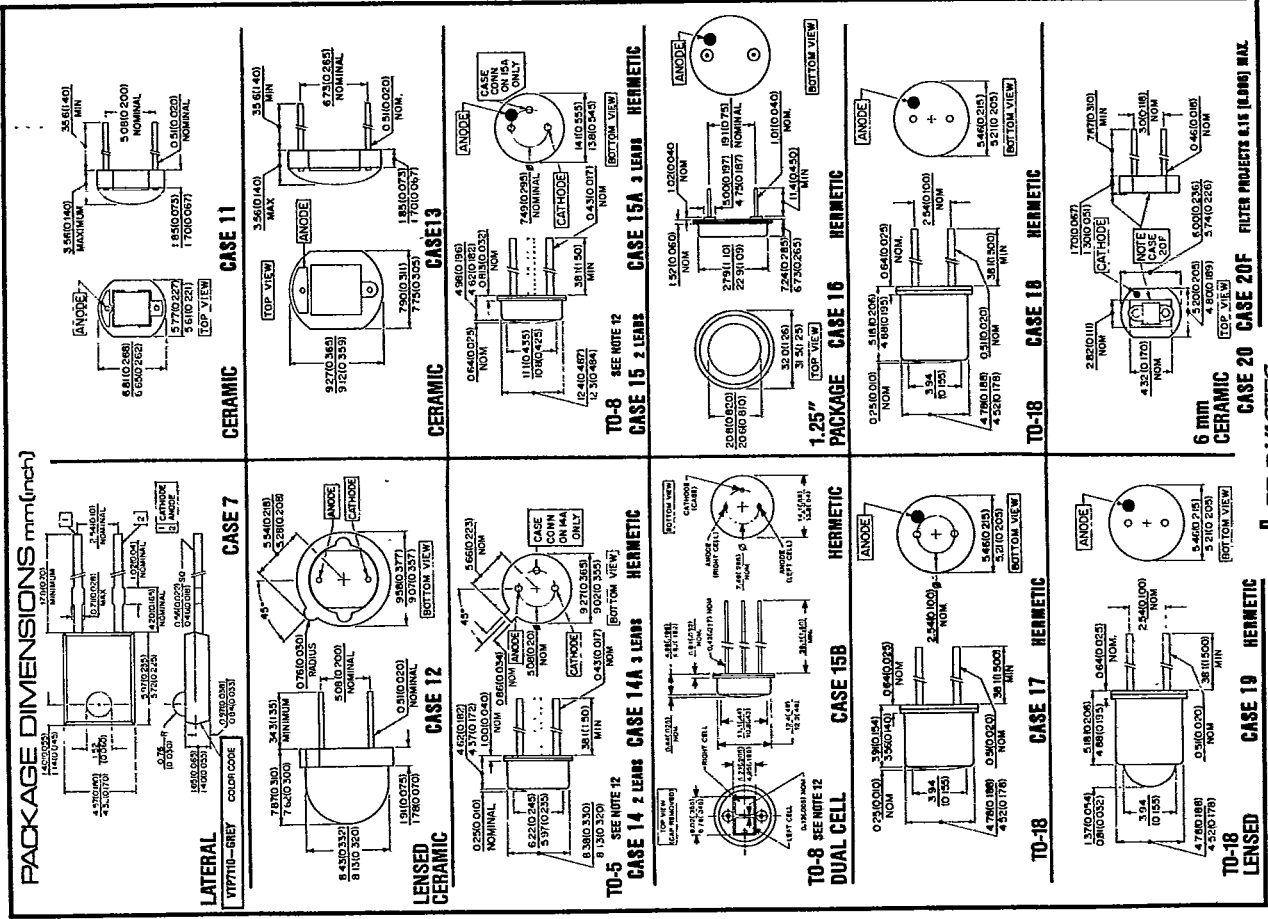

PACKAGE DIMENSIONS mm (inch)

LATERAL

V17710-BRET COLOR CODE 01-02-03

CERAMIC

CASE 11

LENSSED CERAMIC

CASE 12

CERAMIC

CASE 13

TO-8 SEE NOTE 12

CASE 14 3 LEADS HERMETIC

TO-8 SEE NOTE 12

CASE 15A 3 LEADS HERMETIC

TO-8 SEE NOTE 12

DUAL CELL

CASE 15B

HERMETIC

TO-8 SEE NOTE 12

PACKAGE

CASE 16

HERMETIC

TO-18

CASE 17

HERMETIC

TO-18

CASE 18

HERMETIC

TO-18

CASE 19

HERMETIC

TO-18

CASE 20

HERMETIC

SILICON PHOTODIODES

PREFIX	DESCRIPTION	PAGE
VTB	Blue Enhanced	10, 11
VTP	Fast Response	12
	Large Area	
VTS-1	Solar Process	13
VTS-2	Low Capacitance	14
VTS-3	Super Blue Enhanced	15
	Specification Notes	11
	Application Information	9
	Package Dimensions	7, 8

APPLICATION INFORMATION

ABSOLUTE MAXIMUM RATINGS

PARAMETER	CASE STYLE			
	HERMETIC	CERAMIC	EPOXY	UNMOUNTED
TEMPERATURE RANGE OPERATING - °C STORAGE - °C	14 14A 15 15A 17 18 19	11 12 13 20 20F 21 21F	7 22 50 51 52 52A	44 45 20 SERIES 31 SERIES 30 SERIES
LEAD SOLDERING TEMP. (1.6 mm from case, 5 Sec max) °C	-40 + 125 -65 + 150	-20 + 75 -40 + 85	-40 + 85 -40 + 100	-40 + 125 -65 + 150 -40 + 105 -40 + 105
	260	260	230	NOTE (10)

GENERAL

All silicon diodes are light sensitive. When the junction geometry is such that the light sensitivity is optimized, the device is called a photodiode. Photodiodes may be operated with reverse voltage bias (photoconductive mode) or without (photovoltaic mode). In either case, the current through the diode is proportional to the radiation falling on the junction. Photodiodes which are intended for photovoltaic operation may not have a reverse voltage rating but in all other respects are the same as any other photodiode. Diodes which are used for solar power conversion are called photovoltaic cells because they are always operated in the photovoltaic mode.

Most detector diodes are used in the photovoltaic mode with a short circuit termination. This yields the most linear light to current conversion. Short circuit operation is simply achieved using an operational amplifier with a transimpedance connection. A typical circuit is shown on page 10. Since there is no dark current through the cell, as there is no applied voltage, detection and measurement circuits can be operated on a DC basis avoiding the extra hardware and circuitry required by chopped light sources.

CASE STYLE AND HANDLING PRECAUTION

Diodes presented in this catalogue are mounted in several different types of cases or may be supplied unmounted. A brief description of the case style for each item is given in the tables. Hermetic cases have glass to metal seals. The chips are mounted directly to the case or may be insulated from the case. The latter allows the metal can to be used as a shield to reduce noise pickup in high gain circuits. Hermetic cases, while quite rugged, must be protected from stresses on the glass seal around the wires and lens.

EQUIVALENT CIRCUIT

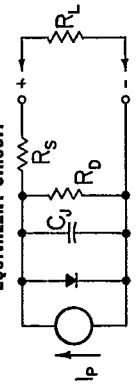

FIGURE I

Ceramic cases utilize an epoxy overcoating to protect the chip. These are very rugged parts but in some units, the chip is close to the surface.

Epoxy cases may be molded or cast. Scratches on the epoxy will degrade electro-optical characteristics.

Unmounted cells in the VTS1, 2 and 3 series are fragile, especially when the area is large. The front and back electrodes are solder coated and may be soldered using a 60/40 tin-lead solder. The flux should be active so that the joint may be made quickly to minimize heating. Whenever possible, it is recommended that soldering be done at VACTEC since excessive heat may degrade the device parameters. Avoid handling leadless cells with bare fingers since they do not have the protective coating provided on cells with flying leads.

ELECTRO OPTICAL CHARACTERISTICS

The equivalent circuit of a photodiode is shown in Figure I. It consists of an ideal current generator in parallel with an ideal diode. The junction capacitance, dark resistance and series resistance account for the other diode parameters.

a. Radiometric sensitivity: The current generated depends upon the energy and wavelength of the radiation actually falling on the junction. The Absolute Response curves indicate the amperes generated by a diode for each watt irradiating the junction when the wavelength is known and is independent of the junction area.

b. Quantum efficiency of a diode is related to the radiometric sensitivity by the following formula

$$Q.E. = \frac{124 S_r}{\lambda}$$

Where S_r = radiometric sensitivity, amperes per watt
 λ = wavelength, micrometers

The equation relates the energy per photon and the quantum yield, electrons per photon. One hundred percent Q.E. indicates that each photon produces one electron.

c. Responsivity, R_e is the parameter which accounts for chip area and is the output current per unit of irradiance.

$$R_e = \frac{I_p}{E_e} \mu A / (\mu W / cm^2)$$

Also $R_e = K S_h A$

Where I_p = Photo generated current, μA

E_e = Irradiance, $\mu W / cm^2$

A = Active area of the chip, cm^2

K = constant and accounts for case effects such as lensing, coating etc.

d. Light current, I_p is the current produced by the diode under a specified irradiation, E_e or illumination, E_e . Typical types of radiation sources are incandescent lamps (2850K source), LEDs (typically 840 nm), mercury line source (365nm) and solar equivalent illumination (100 mW/cm²).

e. Linearity The voltage-current transfer curves are shown in Figure II. The polarity convention used is the same as a non-light sensitive diode. Photovoltaic operation occurs in the 4th quadrant. The open circuit voltage is shown as the intersection of the transfer curve and the horizontal axis. The short circuit current is shown as the intersection of the transfer curves and the vertical axis. This is the most linear method of operation, in the 3rd quadrant, the diode is operating with reverse bias and it is apparent that the current changes only a few percent with changes in voltage. The diode can therefore be considered a constant current source. In the 1st quadrant, the diode is forward biased from 500mV to 1.2V depending on the chip size and process. Linearity is limited at the high current level by the internal series resistance. At the low current level the limitation is the dark resistance. Diodes with very high dark resistance may be operated at levels from picoamperes to milliamperes with only 1-2% linearity errors.

VOLT-AMPERE CHARACTERISTICS

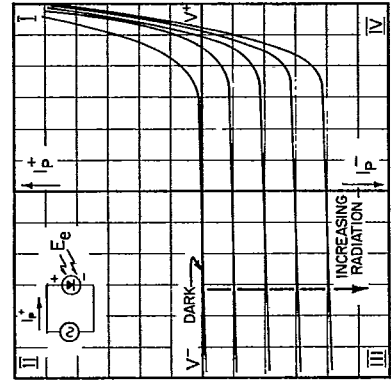

FIGURE II

f. Dark resistance is determined by the application of a small voltage to the cell, typically 10mV and measuring the current. This parameter is voltage sensitive but is useful in calculating the offset gain ($G_{off} = 1 + R_p/R_D$) in transimpedance amplifier circuits.

g. Dark current is measured with a reverse voltage applied to the cell. This voltage may be as low as 100mV or as high as 50V and the dark currents may vary from pA to μA depending upon the chip size and process. It changes very little with reverse voltage but diodes should not be operated at any voltage higher than the dark test voltage or the breakdown voltage if it is stated as a minimum.

h. Breakdown voltage is determined by the process but is a screened parameter. Diodes normally intended for photovoltaic operation do not have this parameter specified.

i. Open circuit voltage has a logarithmic characteristic, limited at low illumination levels by the dark resistance. Due to the high temperature coefficient, this characteristic is difficult to use since it requires careful compensation.

j. Response time of a diode depends upon the wavelength of the radiation, applied voltage, junction capacitance and load resistance. Characteristic curves given with each process show that the non-saturated response time is largely dependent upon the product of the junction capacitance and load resistance. However, when this product is small, other effects become significant and limit the response time. Long wavelength irradiation is absorbed below the depletion region and carriers diffuse slowly since there is little accelerating potential. When carrier lifetime is high, this component will be a significant portion of the photocurrent causing the response time to deviate from a single exponential curve. Increasing the bias voltage widens the depletion region so that more carriers are generated there. At 940nm, the 90% absorption depth is 1.15 micrometers. The VTP diodes require 50V to achieve this depletion width. For fastest response, use shorter wavelength sources. Request NOTE 82M62 for a more detailed discussion.

k. Temperature affects the spectral response as well as the dark resistance and current. Typical temperature variation of spectral sensitivity characteristics are shown for each process. The primary source of this variation is the change in absorption coefficient with temperature. In effect, this causes a shift in the absolute spectral response to the longer wavelengths.

l. Noise in diodes is generated by random fluctuations of carriers. In measurement and control applications, the major concern is flicker and popcorn noise. When the signal level is low, noise bursts can be a problem. Noise currents on the VTB and VTP process diodes are in the range of 10-15 to 10-14 A/Hz. Noise currents on the VTS1, 2 and 3 series are slightly higher. Request NOTE 82M63 for more detailed discussion.