

### Cubic, Single-pole 10A Power Relay

- L 19.6 x W 15.6 x H 15.2 (mm)
- Subminiature 'Sugar Cube' relays.
- Standard 360mW – Lower Coil power consumption.
- Standard Class B insulation, (Class F available).
- Standard CTI 175, (CTI 250 available).
- Withstands impulse of up to 4,500V.
- Environmentally friendly product – Cd, Pb and Chromium free.

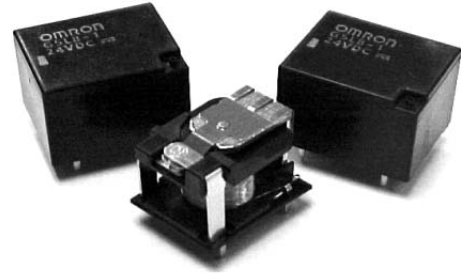

### Ordering Information

Sealing	Contact Form	Contact Material
		AgSnO <sub>2</sub>
Unsealed (vent hole)	SPDT	G5LB-1
	SPST-NO	G5LB-1A
Plastic-sealed	SPDT	G5LB-14
	SPST-NO	G5LB-1A4

**Note:** When ordering, add the rated coil voltage to the number.

Examples : G5LB-1 12 VDC  
└──────────┘ Rated Coil Voltage

#### Model Number Legend

**G5LB**                 **VDC**  
1 2 3 4 5 6 7 8

#### 1. Number of Poles

1: 1 pole

#### 2. Contact Form/Contact Construction

None: SPDT  
 A: SPST-NO

#### 3. Sealing/Protective Construction

None: Unsealed (vent hole)  
 4: Sealed

#### 4. Contact Type

None: Standard (Silver Tin Oxide)

#### 5. Coil Power Consumption

None: 360mW  
 40: 400mW  
 60: 600mW (UL and CSA only)

#### 6. Tracking Index and Insulation

None: CTI >175 – Class B Insulation (colour: black)  
 25: CTI >250 – Class F Insulation (colour: white)

#### 7. Optional Suffix(es)

None: Standards  
 May include additional numbers(s) and / or letter(s) for sales purposes

#### 8. Rated Coil Value

## ■ Coil Ratings

Rated voltage	3 VDC	5 VDC	6 VDC	9 VDC	12 VDC	24 VDC	36 VDC	48 VDC
Rated current	123.3 mA	72.0 mA	60.8 mA	40.8 mA	30.7 mA	15.2 mA	10.2 mA	7.6 mA
Coil resistance	24.3 Ω	69.4 Ω	98.7 Ω	220.4 Ω	390.6 Ω	1575.4 Ω	3533.7 Ω	6287.4 Ω
Must operate voltage	75% of rated voltage (max.)							
Must release voltage	10% of rated voltage (min.)							
Max. voltage	130% of rated voltage at 85°C, 170% of rated voltage at 23°C							
Power consumption	Approx. 360 mW							

**Note:** The rated current and coil resistance are measured at a coil temperature of 23°C with a tolerance of ±10%.

www.DataSheet4U.com

Rated voltage	3 VDC	5 VDC	6 VDC	9 VDC	12 VDC	24 VDC	36 VDC	48 VDC
Rated current	136.4 mA	80.0 mA	67.8 mA	45.7 mA	32.8 mA	17.0 mA	11.3 mA	8.5 mA
Coil resistance	22.0 Ω	62.5 Ω	88.5 Ω	196.9 Ω	366.0 Ω	1,407.7 Ω	3,196.8 Ω	5,638.0 Ω
Must operate voltage	75% of rated voltage (max.)							
Must release voltage	10% of rated voltage (min.)							
Max. voltage	130% of rated voltage at 85°C, 170% of rated voltage at 23°C							
Power consumption	Approx. 400 mW							

**Note:** The rated current and coil resistance are measured at a coil temperature of 23°C with a tolerance of ±10%.

## ■ Contact Ratings

Load	Resistive load (cos Ø=1)
Rated load	10A at 120 VAC, 8A at 30 VDC & 10A at 250 VAC
Rated carry current	10A
Max. switching voltage	250 VAC, 125 VDC (30 VDC when UL/CSA standard is applied)
Max. switching current	AC: 10A; DC: 8A
Max. switching capacity	1,200 VA, 240 W & 2,500 VA
Min. permissible load	100 mA at 5 VDC

■ Characteristics

<b>Contact resistance</b>	100 mΩ max.
<b>Operate time</b>	10 ms max.
<b>Release time</b>	5 ms max.
<b>Max. switching frequency</b>	Mechanical: 18,000 operations/hr Electrical: 1,800 operations/hr (under rated load)
<b>Insulation resistance</b>	100MΩ min. (at 500 VDC)
<b>Dielectric strength</b>	750 VAC, 50/60 Hz for 1 min. between contacts of same polarity 2,000 VAC, 50/60 Hz for 1 min. between coil and contacts
<b>Impulse withstand voltage</b>	4,500V between coil and contacts, 1.2 x 5 μsec
<b>Vibration resistance</b>	Destruction: 10 to 55Hz, 1.5mm double amplitude Malfunction: 10 to 55Hz, 1.5mm double amplitude
<b>Shock resistance</b>	Destruction: 1,000 m/s <sup>2</sup> (approx. 100G) Malfunction: 100 m/s <sup>2</sup> (approx. 10G)
<b>Life expectancy</b>	Mechanical: 10,000,000 operations min. (at 18,000 operations/hr) Electrical: *100,000 operations min. (at 1,800 operations/hr, 10A 120VAC)
<b>Ambient temperature</b>	Operating: -40°C to 85°C
<b>Ambient humidity</b>	Operating: 35% to 85°C
<b>Weight</b>	Approx. 10g

\*G5LB-1

Engineering Data

Max. Switching Capacity G5LB-1

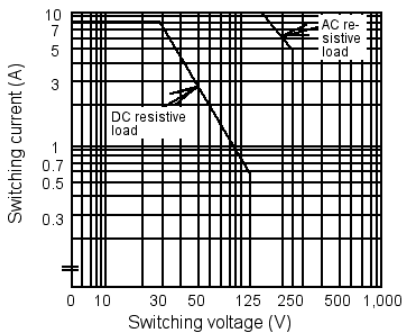

Life Expectancy G5LB-1

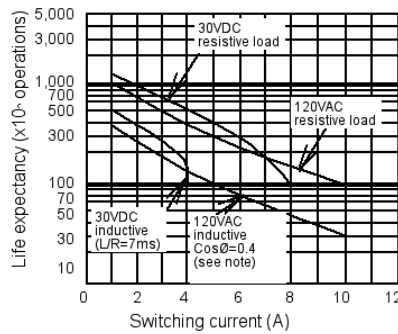

**Note:** Curve 120VAC inductive Cosφ=0.4 is same for 250VAC resistive load.

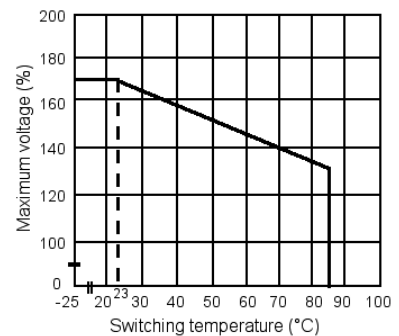

Ambient Temp. Vs Max. Voltage



**Note:** The maximum coil voltage refers to the maximum value in a varying range of operating power voltage, not a continuous voltage.

## Dimensions

Note: 1. All units are millimeters unless otherwise indicated

2. Orientation marks are indicated as follow:  

### ■ SPDT Types

#### G5LB-1

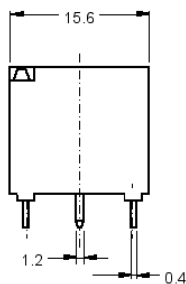
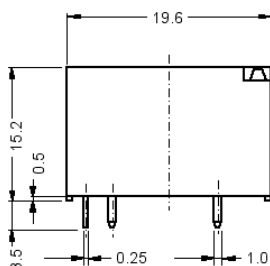

Terminal Arrangement/  
Internal Connections  
(Bottom View)

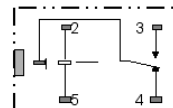

Mounting Holes  
(Bottom View)  
Tolerance:  $\pm 0.1\text{mm}$

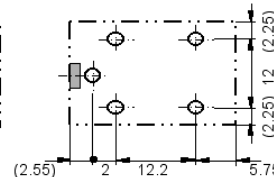

#### G5LB-14

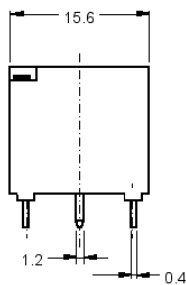
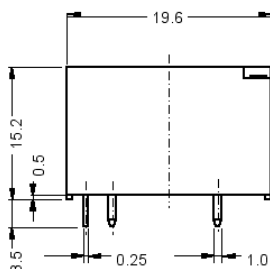

Terminal Arrangement/  
Internal Connections  
(Bottom View)

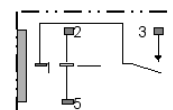

Mounting Holes  
(Bottom View)  
Tolerance:  $\pm 0.1\text{mm}$

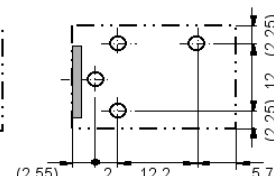

### ■ SPST Types

#### G5LB-1A

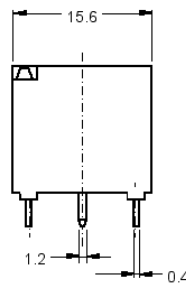
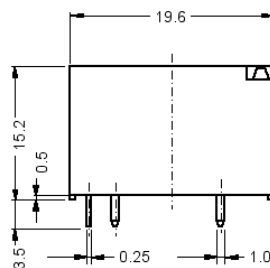

Terminal Arrangement/  
Internal Connections  
(Bottom View)

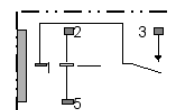

Mounting Holes  
(Bottom View)  
Tolerance:  $\pm 0.1\text{mm}$

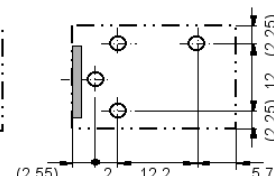

#### G5LB-1A4

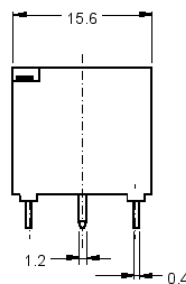
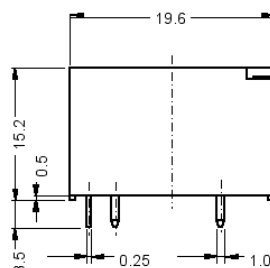

Terminal Arrangement/  
Internal Connections  
(Bottom View)

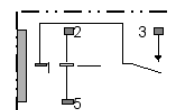

Mounting Holes  
(Bottom View)  
Tolerance:  $\pm 0.1\text{mm}$

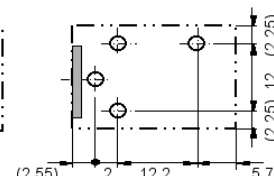

ALL DIMENSIONS SHOWN ARE IN MILLIMETERS.

To convert millimeters into inches, multiply by 0.03937. To convert grams into ounces, multiply by 0.03527.

Cat. No. G5LB

In the interest of product improvement, specifications are subject to change without notice.

# OMRON

## Omron Electronic Components Europe BV

Wegalaan 57

2132 JD Hoofddorp

The Netherlands

Tel: +31 23 568 1200

Fax: +31 23 568 1212

[www.DataSheet4U.com](http://www.DataSheet4U.com)