



# TDA7563

## MULTIFUNCTION QUAD POWER AMPLIFIER WITH BUILT-IN DIAGNOSTICS FEATURES

- DMOS POWER OUTPUT
- NON-SWITCHING HI-EFFICIENCY
- HIGH OUTPUT POWER CAPABILITY 4x28W/4Ω @ 14.4V, 1KHZ, 10% THD, 4x40W EIAJ
- MAX. OUTPUT POWER 4x72W/2Ω
- FULL I<sup>2</sup>C BUS DRIVING:
  - ST-BY
  - INDEPENDENT FRONT/REAR SOFT PLAY/MUTE
  - SELECTABLE GAIN 30dB
  - 16dB (FOR LOW NOISE LINE OUTPUT FUNCTION)
  - HIGH EFFICIENCY ENABLE/DISABLE
  - I<sup>2</sup>C BUS DIGITAL DIAGNOSTICS
- FULL FAULT PROTECTION
- DC OFFSET DETECTION
- FOUR INDEPENDENT SHORT CIRCUIT PROTECTION
- CLIPPING DETECTOR PIN WITH SELECTABLE THRESHOLD (2%/10%)
- ST-BY/MUTE PIN
- LINEAR THERMAL SHUTDOWN
- ESD PROTECTION

**MULTIPOWER BCD TECHNOLOGY**

**MOSFET OUTPUT POWER STAGE**

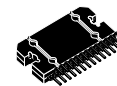

**FLEXIWATT27**

**ORDERING NUMBER: TDA7563**

### DESCRIPTION

The TDA7563 is a new BCD technology Quad Bridge type of car radio amplifier in Flexiwatt27 package specially intended for car radio applications. Thanks to the DMOS output stage the TDA7563 has a very low distortion allowing a clear powerful sound. Among the features, its superior efficiency performance coming from the internal exclusive structure, makes it the most suitable device to simplify the thermal management in high power sets. The dissipated output power under average listening condition is in fact reduced up to 50% when compared to the level provided by conventional class AB solutions. This device is equipped with a full diagnostics array that communicates the status of each speaker through the I<sup>2</sup>C bus.

### BLOCK DIAGRAM

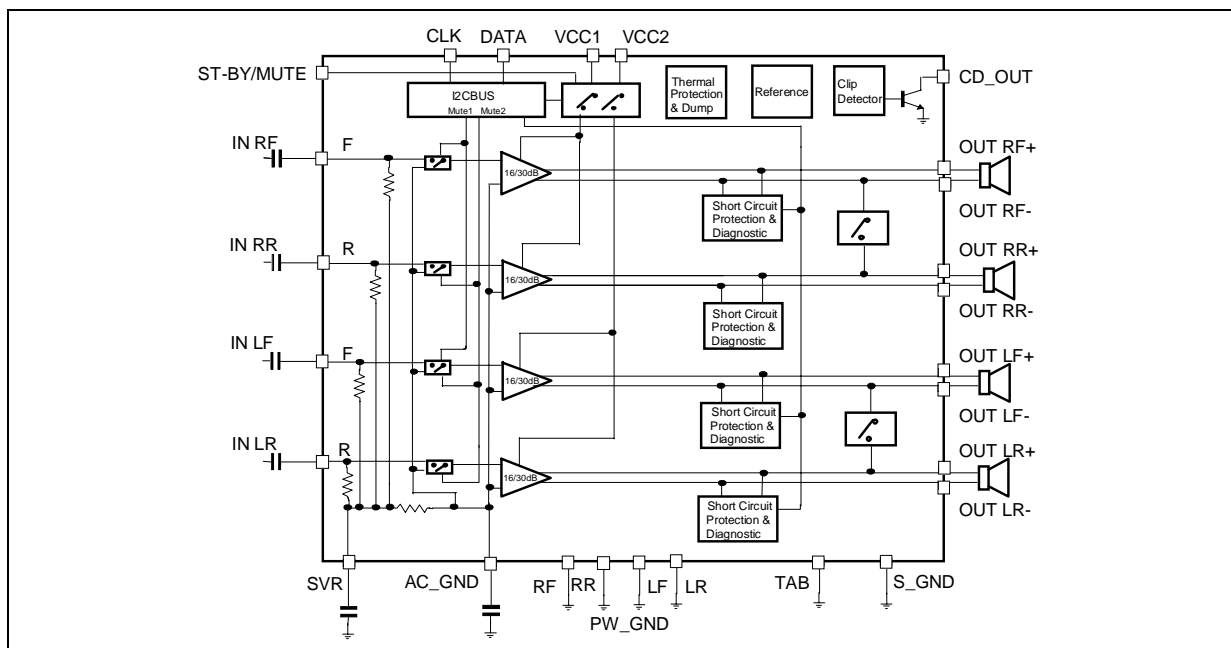

**ABSOLUTE MAXIMUM RATINGS**

| Symbol         | Parameter   | Value      | Unit        |
|----------------|---|------------|-------------|
| $V_{op}$       | Operating Supply Voltage                          | 18         | V           |
| $V_S$          | DC Supply Voltage                                 | 28         | V           |
| $V_{peak}$     | Peak Supply Voltage (for $t = 50ms$ )             | 50         | V           |
| $V_{CK}$       | CK pin Voltage                                    | 6          | V           |
| $V_{DATA}$     | Data Pin Voltage                                  | 6          | V           |
| $I_O$          | Output Peak Current (not repetitive $t = 100ms$ ) | 8          | A           |
| $I_O$          | Output Peak Current (repetitive $f > 10Hz$ )      | 6          | A           |
| $P_{tot}$      | Power Dissipation $T_{case} = 70^{\circ}C$        | 85         | W           |
| $T_{stg}, T_j$ | Storage and Junction Temperature                  | -55 to 150 | $^{\circ}C$ |

**THERMAL DATA**

| Symbol           | Parameter                           | Value  | Unit          |
|------------------|-------------------------------------|--------|---------------|
| $R_{th\ j-case}$ | Thermal Resistance Junction to case | Max. 1 | $^{\circ}C/W$ |

**PIN CONNECTION (Top view)**

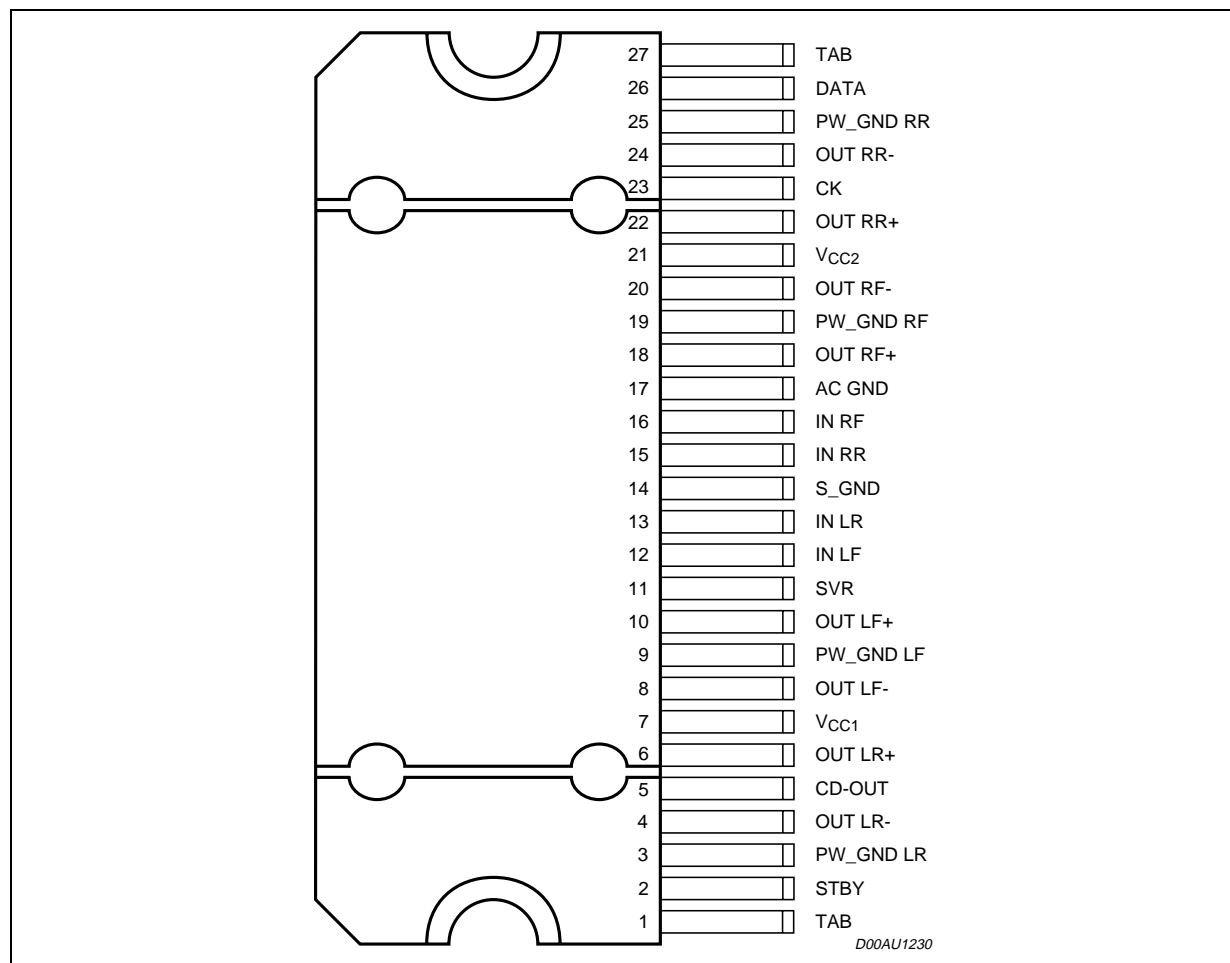
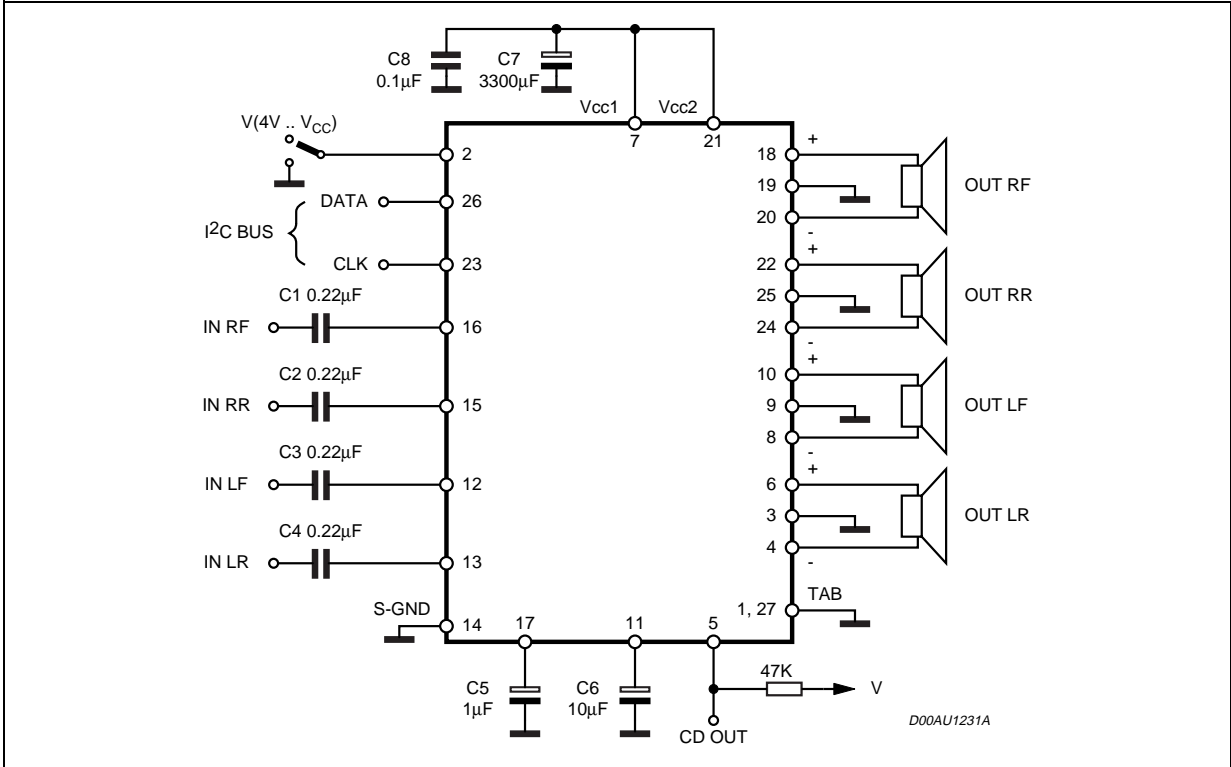

Figure 1. Application Circuit



**ELECTRICAL CHARACTERISTICS**

(Refer to the test circuit,  $V_S = 14.4V$ ;  $R_L = 4\Omega$ ;  $f = 1KHz$ ;  $G_V = 30dB$ ;  $T_{amb} = 25^\circ C$ ; unless otherwise specified.)

| Symbol                 | Parameter                     | Test Condition   | Min. | Typ. | Max.  | Unit       |
|------------------------|-------------------------------|--|------|------|-------|------------|
| <b>POWER AMPLIFIER</b> |                               |  |      |      |       |            |
| $V_S$                  | Supply Voltage Range          |  | 8    |      | 18    | V          |
| $I_d$                  | Total Quiescent Drain Current |  |      | 170  | 300   | mA         |
| $P_O$                  | Output Power                  | EIAJ ( $V_S = 13.7V$ )                                       | 35   | 40   |       | W          |
|                        |                               | THD = 10%  | 25   | 28   |       | W          |
|                        |                               | THD = 1%   |      | 22   |       | W          |
|                        |                               | $R_L = 2\Omega$ ; EIAJ ( $V_S = 13.7V$ )                     | 55   | 62   |       | W          |
|                        |                               | $R_L = 2\Omega$ ; THD 10%                                    | 40   | 46   |       | W          |
|                        | $R_L = 2\Omega$ ; THD 1%      |  |      | 35   |       | W          |
|                        | $R_L = 2\Omega$ ; MAX POWER   |  |      | 72   |       | W          |
| THD                    | Total Harmonic Distortion     | $P_O = 1W$ to $10W$ ; STD MODE                               |      | 0.03 | 0.1   | %          |
|                        |                               | HE MODE; $P_O = 1.5W$  |      | 0.02 | 0.1   | %          |
|                        |                               | HE MODE; $P_O = 8W$  |      | 0.15 | 0.5   | %          |
|                        |                               | $P_O = 1-10W$ , $f = 10kHz$                                  |      | 0.2  | 0.5   | %          |
|                        |                               | $G_V = 16dB$ ; STD Mode<br>$V_O = 0.1$ to $5VRMS$            |      | 0.02 | 0.05  | %          |
| $C_T$                  | Cross Talk                    | $f = 1KHz$ to $10KHz$ , $R_g = 600\Omega$                    | 50   | 60   |       | dB         |
| $R_{IN}$               | Input Impedance               |  | 60   | 100  | 130   | K $\Omega$ |
| $G_{V1}$               | Voltage Gain 1                |  | 29.5 | 30   | 30.5  | dB         |
| $\Delta G_{V1}$        | Voltage Gain Match 1          |  | -1   |      | 1     | dB         |
| $G_{V2}$               | Voltage Gain 2                |  | 15.5 | 16   | 16.5  | dB         |
| $\Delta G_{V2}$        | Voltage Gain Match 2          |  | -1   |      | 1     | dB         |
| $E_{IN1}$              | Output Noise Voltage 1        | $R_g = 600\Omega$ 20Hz to 22kHz                              |      | 50   | 100   | mV         |
| $E_{IN2}$              | Output Noise Voltage 2        | $R_g = 600\Omega$ ; $G_V = 16dB$<br>20Hz to 22kHz            |      | 15   | 30    | mV         |
| SVR                    | Supply Voltage Rejection      | $f = 100Hz$ to $10kHz$ ; $V_r = 1Vpk$ ;<br>$R_g = 600\Omega$ | 50   | 60   |       | dB         |
| BW                     | Power Bandwidth               |  | 100  |      |       | KHz        |
| $A_{SB}$               | Stand-by Attenuation          |  | 90   | 110  |       | dB         |
| $I_{SB}$               | Stand-by Current              |  |      | 2    | 20    | $\mu A$    |
| $A_M$                  | Mute Attenuation              |  | 80   | 100  |       | dB         |
| $V_{OS}$               | Offset Voltage                | Mute & Play  | -100 | 0    | 100   | mV         |
| $V_{AM}$               | Min. Supply Mute Threshold    |  | 7    | 7.5  | 8     | V          |
| $T_{ON}$               | Turn ON Delay                 | D2/D1 (IB1) 0 to 1   |      | 5    | 20    | ms         |
| $T_{OFF}$              | Turn OFF Delay                | D2/D1 (IB1) 1 to 0   |      | 5    | 20    | ms         |
| $V_{SBY}$              | St-By/Mute pin for St-By      |  | 0    |      | 1.5   | V          |
| $V_{MU}$               | St-By/Mute pin for Mute       |  | 3.5  |      | 5     | V          |
| $V_{OP}$               | St-By/Mute pin for Operating  |  | 7    |      | $V_S$ | V          |
| $I_{MU}$               | St-By/Mute pin Current        | $V_{STBY/MUTE} = 8.5V$                                       |      | 20   | 40    | $\mu A$    |
|                        |                               | $V_{STBY/MUTE} < 1.5V$                                       |      | 0    | 10    | $\mu A$    |
| $CD_{LK}$              | Clip Det High Leakage Current | CD off   |      | 0    | 15    | $\mu A$    |
| $CD_{SAT}$             | Clip Det Sat. Voltage         | CD on; $I_{CD} = 1mA$  |      | 300  |       | mV         |
| $CD_{THD}$             | Clip Det THD level            | D0 (IB1) = 1   | 5    | 10   | 15    | %          |

**ELECTRICAL CHARACTERISTICS** (continued)(Refer to the test circuit,  $V_S = 14.4V$ ;  $R_L = 4\Omega$ ;  $f = 1KHz$ ;  $G_V = 30dB$ ;  $T_{amb} = 25^\circ C$ ; unless otherwise specified.)

| Symbol  | Parameter  | Test Condition   | Min.      | Typ.    | Max.      | Unit     |
|---|--|--|-----------|---------|-----------|----------|
|   |  | D0 (IB1) = 0   | 1         | 2       | 3         | %        |
| <b>TURN ON DIAGNOSTICS 1 (Power Amplifier Mode)</b>                       |  |  |           |         |           |          |
| Pgnd  | Short to GND det. (below this limit, the Output is considered in Short Circuit to GND)       | Power Amplifier in st-by   |           |         | 1.2       | V        |
| Pvs   | Short to Vs det. (above this limit, the Output is considered in Short Circuit to VS)         |  | Vs -1.2   |         |           | V        |
| Pnop  | Normal operation thresholds. (Within these limits, the Output is considered without faults). |  | 1.8       |         | Vs -1.8   | V        |
| Lsc   | Shorted Load det.  |  |           |         | 0.5       | $\Omega$ |
| Lop   | Open Load det.   |  | 130       |         |           | $\Omega$ |
| Lnop  | Normal Load det.   |  | 1.5       |         | 70        | $\Omega$ |
| <b>TURN ON DIAGNOSTICS 2 (Line Driver Mode)</b>                           |  |  |           |         |           |          |
| Pgnd  | Short to GND det. (below this limit, the Output is considered in Short Circuit to GND)       | Power Amplifier in st-by   |           |         | 1.2       | V        |
| Pvs   | Short to Vs det. (above this limit, the Output is considered in Short Circuit to VS)         |  | Vs -1.2   |         |           | V        |
| Pnop  | Normal operation thresholds. (Within these limits, the Output is considered without faults). |  | 1.8       |         | Vs -1.8   | V        |
| Lsc   | Shorted Load det.  |  |           |         | 1.5       | $\Omega$ |
| Lop   | Open Load det.   |  | 400       |         |           | $\Omega$ |
| Lnop  | Normal Load det.   |  | 4.5       |         | 200       | $\Omega$ |
| <b>PERMANENT DIAGNOSTICS 2 (Power Amplifier Mode or Line Driver Mode)</b> |  |  |           |         |           |          |
| Pgnd  | Short to GND det. (below this limit, the Output is considered in Short Circuit to GND)       | Power Amplifier in Mute or Play, one or more short circuits protection activated |           |         | 1.2       | V        |
| Pvs   | Short to Vs det. (above this limit, the Output is considered in Short Circuit to VS)         |  | Vs -1.2   |         |           | V        |
| Pnop  | Normal operation thresholds. (Within these limits, the Output is considered without faults). |  | 1.8       |         | Vs -1.8   | V        |
| Lsc   | Shorted Load Det.  | Pow. Amp. mode   |           |         | 0.5       | $\Omega$ |
|   |  | Line Driver mode   |           |         | 1.5       | $\Omega$ |
| VO  | Offset Detection   | Power Amplifier in play, AC Input signals = 0                                    | $\pm 1.5$ | $\pm 2$ | $\pm 2.5$ | V        |
| <b>I<sup>2</sup>C BUS INTERFACE</b>                                       |  |  |           |         |           |          |
| SCL   | Clock Frequency  |  |           |         | 400       | KHz      |
| VIL   | Input Low Voltage  |  |           |         | 1.5       | V        |
| VIH   | Input High Voltage   |  | 2.3       |         |           | V        |

Figure 2. Quiescent Current vs. Supply Voltage

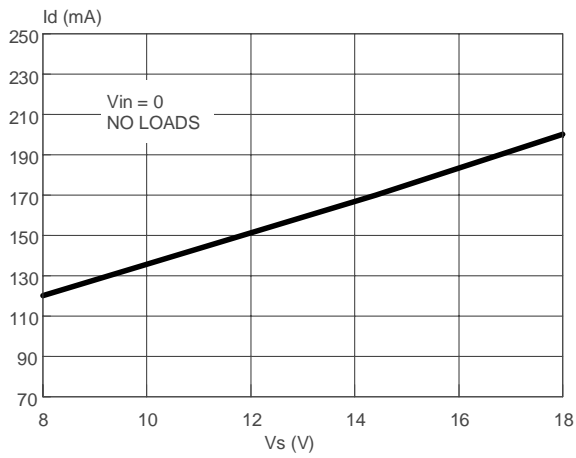

Figure 5. Distortion vs. Output Power (4Ω, STD)

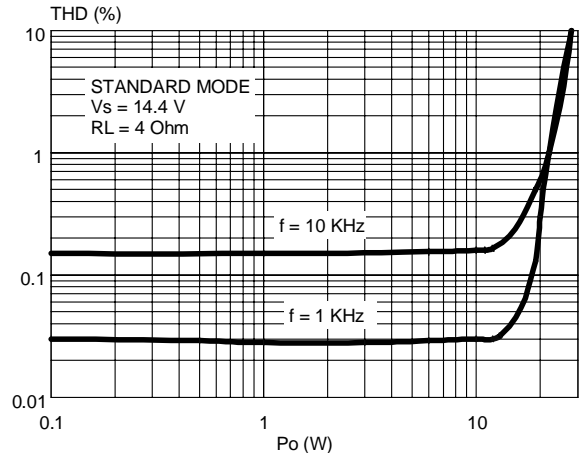

Figure 3. Output Power vs. Supply Voltage (4Ω)

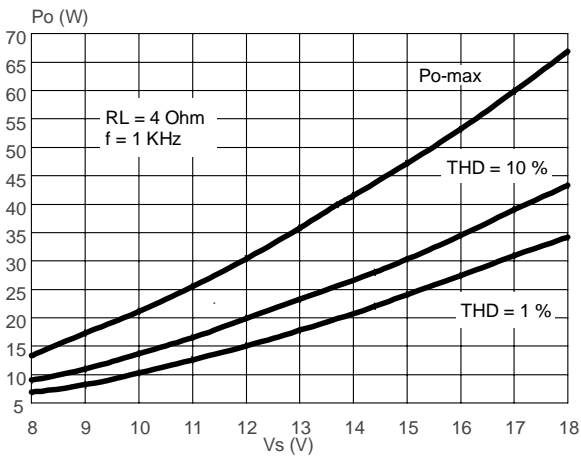

Figure 6. Distortion vs. Output Power (4Ω, HI-EFF)

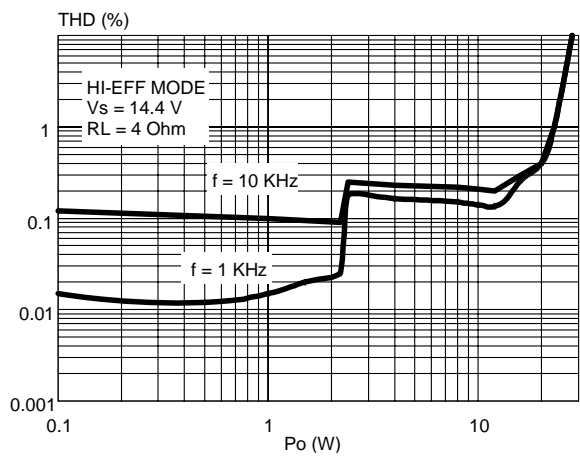

Figure 4. Output Power vs. Supply Voltage (2Ω)

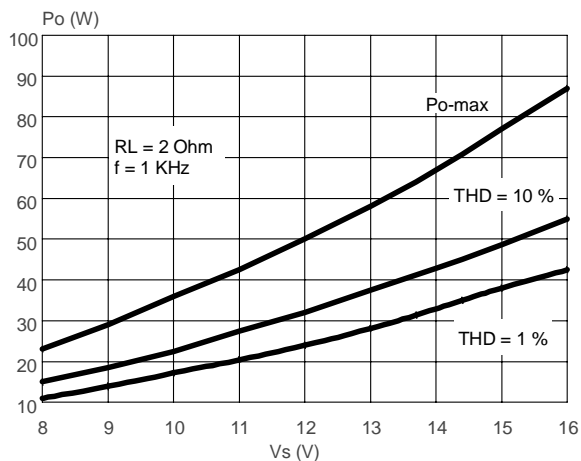

Figure 7. Distortion vs. Output Power (2Ω, STD)

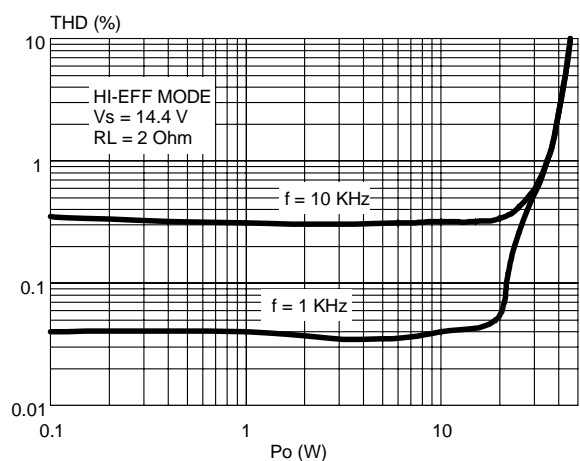

Figure 8. Distortion vs. Frequency (4Ω)

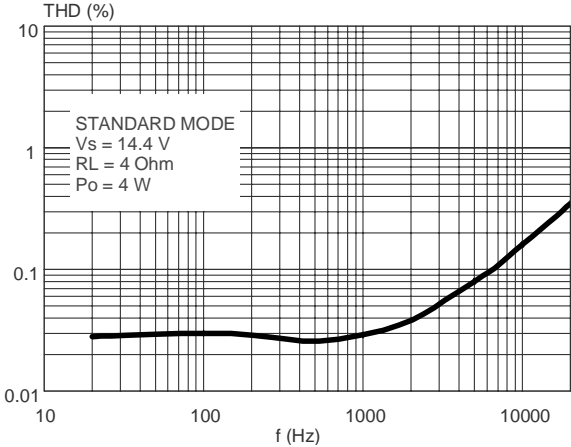

Figure 11. Supply Voltage Rejection vs. Freq.

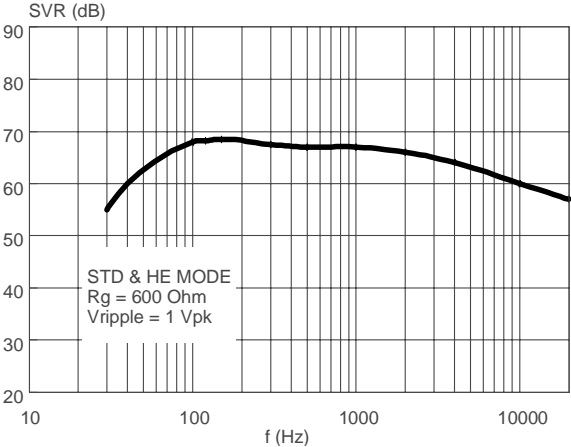

Figure 9. Distortion vs. Frequency (2Ω)

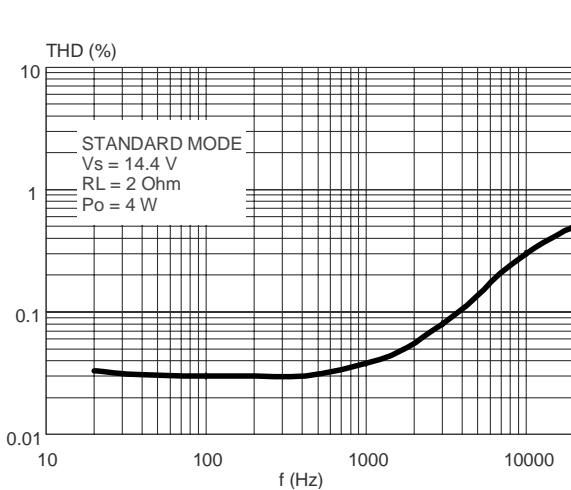

Figure 12. Power Dissipation & Efficiency vs. Output Power (4Ω, STD, SINE)

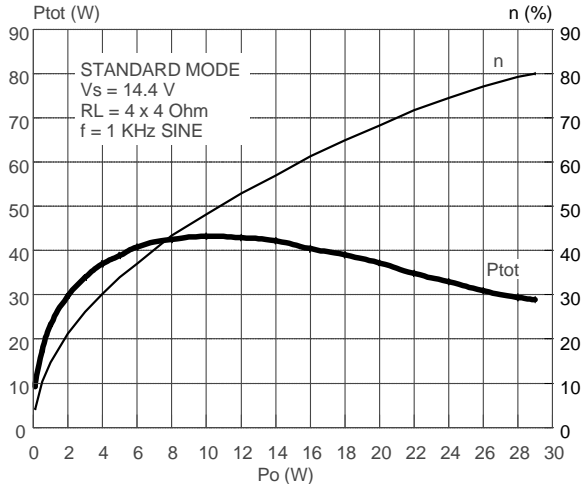

Figure 10. Crosstalk vs. Frequency

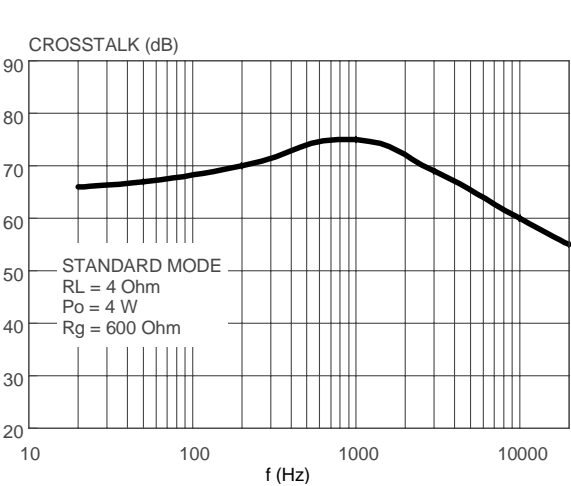
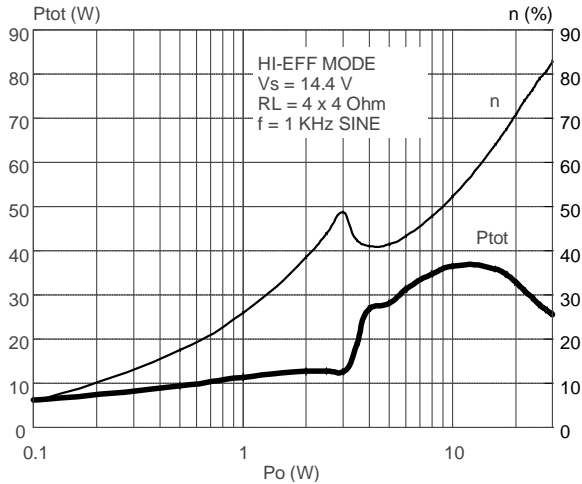
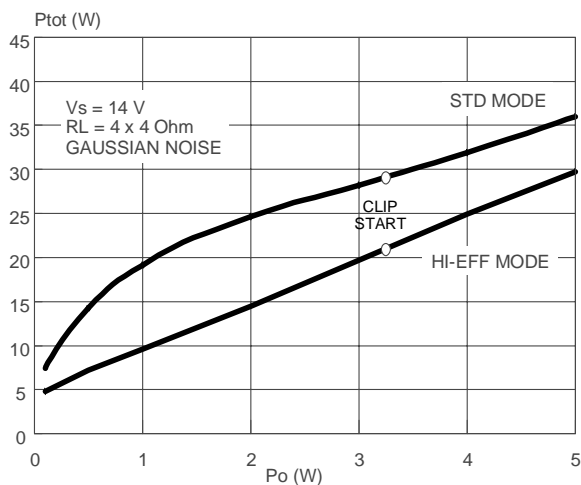

Figure 13. Power Dissipation & Efficiency vs. Output Power (4W, HI-EFF, SINE)



**Figure 14. Power Dissipation vs. Average Output Power (Audio Program Simulation, 4Ω)**



**Figure 15. Power Dissipation vs. Average Output Power (Audio Program Simulation, 2Ω)**

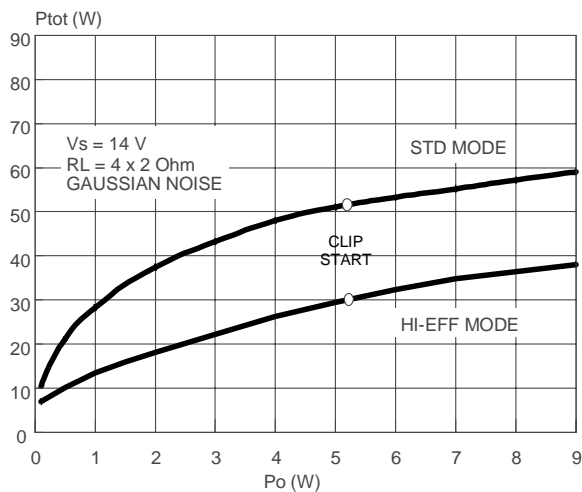

**DIAGNOSTICS FUNCTIONAL DESCRIPTION:**

**a) TURN-ON DIAGNOSTIC**

It is activated at the turn-on (stand-by out) under I<sup>2</sup>Cbus request. Detectable output faults are:

- SHORT TO GND
- SHORT TO Vs
- SHORT ACROSS THE SPEAKER
- OPEN SPEAKER

To verify if any of the above misconnections are in place, a subsonic (inaudible) current pulse (fig. 16) is internally generated, sent through the speaker(s) and sunk back. The Turn On diagnostic status is internally stored until a successive diagnostic pulse is requested (after a I2C reading).

If the "stand-by out" and "diag. enable" commands are both given through a single programming step, the pulse takes place first (power stage still in stand-by mode, low, outputs= high impedance).

Afterwards, when the Amplifier is biased, the PERMANENT diagnostic takes place. The previous Turn On state is kept until a short appears at the outputs.

**Figure 16. Turn - On diagnostic: working principle**

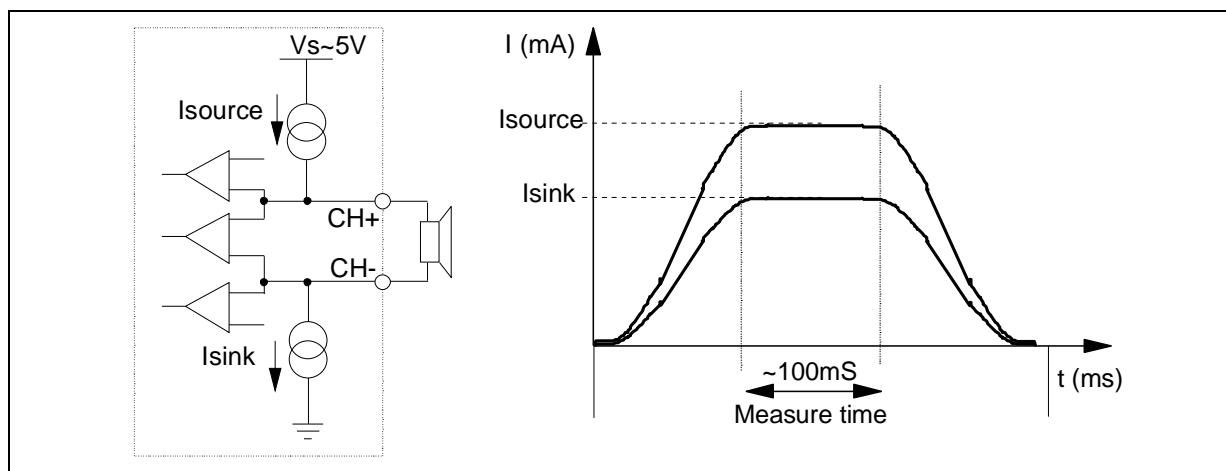



Fig. 17 and 18 show SVR and OUTPUT waveforms at the turn-on (stand-by out) with and without TURN-ON DIAGNOSTIC.

Figure 17. SVR and Output behaviour (CASE 1: without turn-on diagnostic)

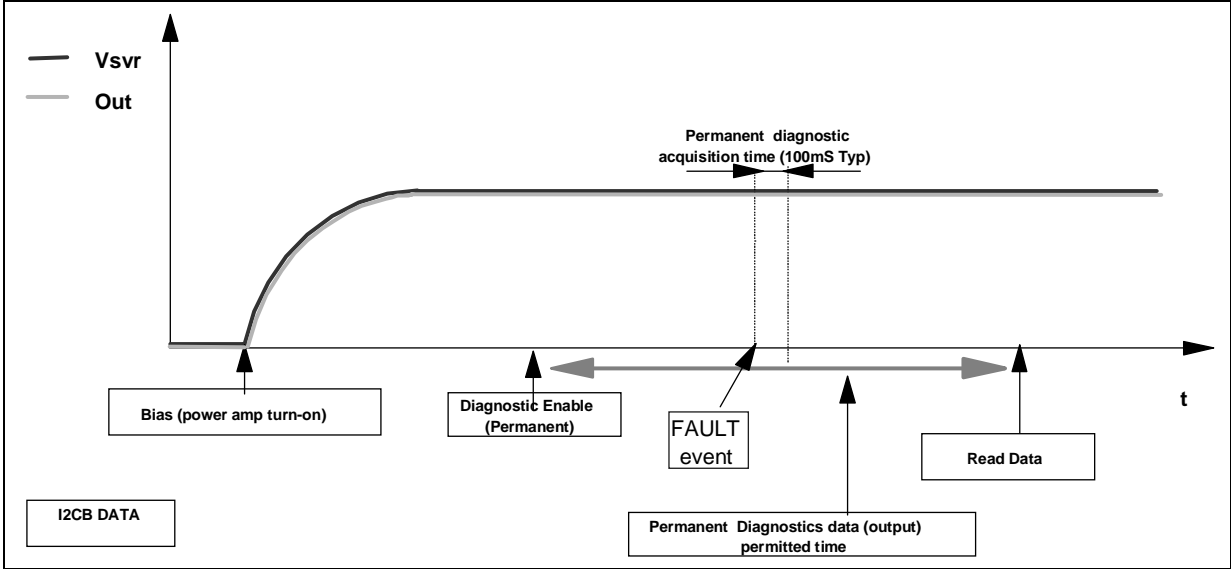
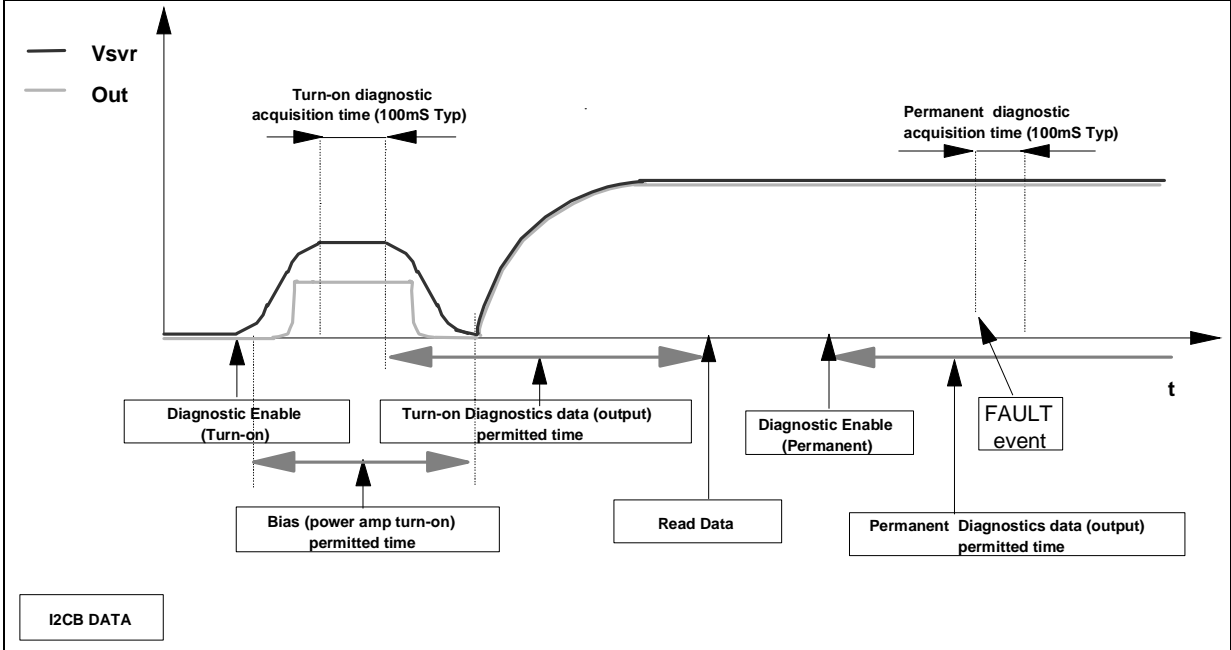
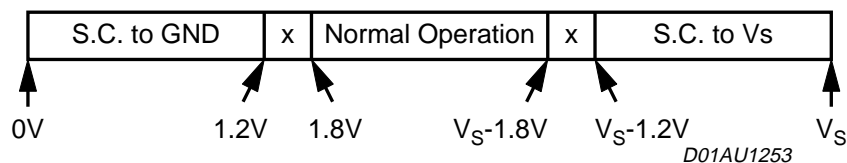

Figure 18. SVR and Output pin behaviour (CASE 2: with turn-on diagnostic)



The information related to the outputs status is read and memorized at the end of the current pulse top. The acquisition time is 100 ms (typ.). No audible noise is generated in the process. As for SHORT TO GND / Vs the fault-detection thresholds remain unchanged from 30 dB to 16 dB gain setting. They are as follows:



Concerning SHORT ACROSS THE SPEAKER / OPEN SPEAKER, the threshold varies from 30 dB to 16 dB gain setting, since different loads are expected (either normal speaker's impedance or high impedance). The values in case of 30 dB gain are as follows:

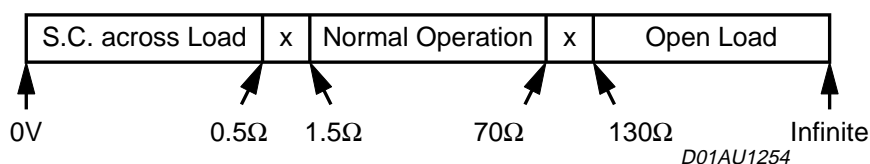

If the Line-Driver mode (Gv= 16 dB and Line Driver Mode diagnostic = 1) is selected, the same thresholds will change as follows:

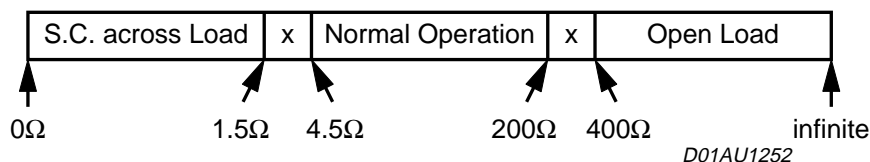

**b) PERMANENT DIAGNOSTICS.**

Detectable conventional faults are:

- SHORT TO GND
- SHORT TO Vs
- SHORT ACROSS THE SPEAKER

The following additional features are provided:

- OUTPUT OFFSET DETECTION

The TDA7563 has 2 operating statuses:

- 1 RESTART mode. The diagnostic is not enabled. Each audio channel operates independently from each other. If any of the a.m. faults occurs, only the channel(s) interested is shut down. A check of the output status is made every 1 ms (fig. 19). Restart takes place when the overload is removed.
- 2 DIAGNOSTIC mode. It is enabled via I<sup>2</sup>C bus and self activates if an output overload (such to cause the intervention of the short-circuit protection) occurs to the speakers outputs . Once activated, the diagnostics procedure develops as follows (fig. 20):

- To avoid momentary re-circulation spikes from giving erroneous diagnostics, a check of the output status is made after 1ms: if normal situation (no overloads) is detected, the diagnostic is not performed and the channel returns back active.
- Instead, if an overload is detected during the check after 1 ms, then a diagnostic cycle having a duration of about 100 ms is started.
- After a diagnostic cycle, the audio channel interested by the fault is switched to RESTART mode. The relevant data are stored inside the device and can be read by the microprocessor. When one cycle has terminated, the next one is activated by an I<sup>2</sup>C reading. This is to ensure continuous diagnostics throughout the car-radio operating time.
- To check the status of the device a sampling system is needed. The timing is chosen at microprocessor level (over half a second is recommended).

**Figure 19. Restart timing without Diagnostic Enable (Permanent) - Each 1mS time, a sampling of the fault is done**

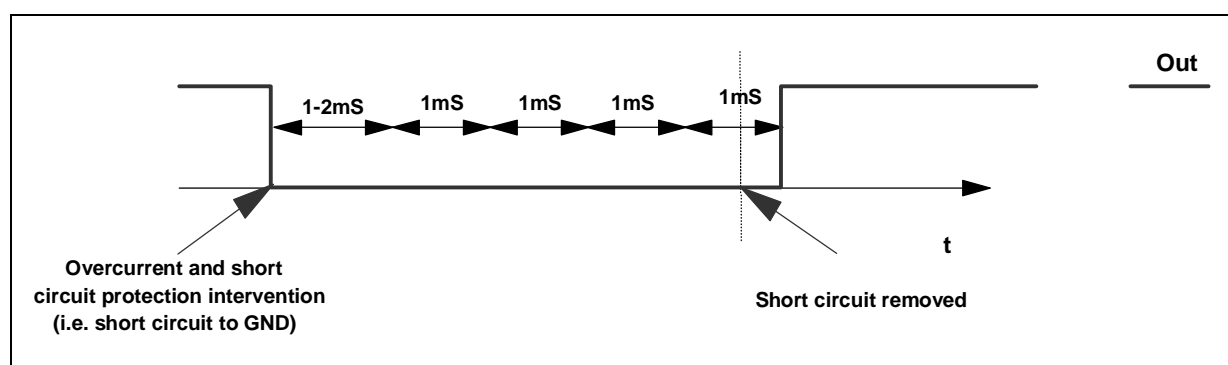

**Figure 20. Restart timing with Diagnostic Enable (Permanent)**

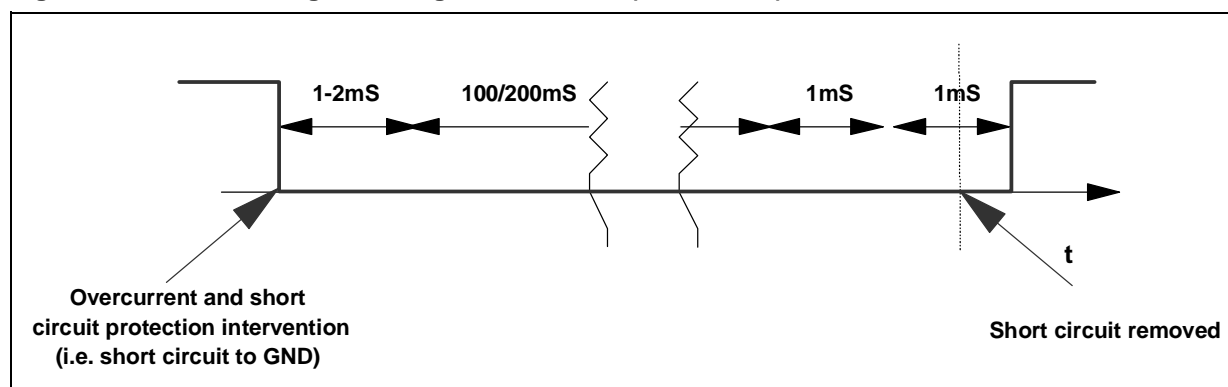

### OUTPUT DC OFFSET DETECTION

Any DC output offset exceeding  $\pm 2$  V are signalled out. This inconvenient might occur as a consequence of initially defective or aged and worn-out input capacitors feeding a DC component to the inputs, so putting the speakers at risk of overheating.

This diagnostic has to be performed with low-level output AC signal (or  $V_{in} = 0$ ).

The test is run with selectable time duration by microprocessor (from a "start" to a "stop" command):

- START = Last reading operation or setting IB1 - D5 - (OFFSET enable) to 1

– STOP = Actual reading operation

Excess offset is signalled out if persistent throughout the assigned testing time. This feature is disabled if any overloads leading to activation of the short-circuit protection occurs in the process.

**MULTIPLE FAULTS**

When more misconnections are simultaneously in place at the audio outputs, it is guaranteed that at least one of them is initially read out. The others are notified after successive cycles of I<sup>2</sup>C reading and faults removal, provided that the diagnostic is enabled. This is true for both kinds of diagnostic (Turn on and Permanent).

The table below shows all the couples of double-fault possible. It should be taken into account that a short circuit with the 4 ohm speaker unconnected is considered as double fault.

| Double fault table for Turn On Diagnostic |             |             |                |              |             |
|---|-------------|-------------|----------------|--------------|-------------|
|   | S. GND (so) | S. GND (sk) | S. Vs          | S. Across L. | Open L.     |
| S. GND (so)                               | S. GND      | S. GND      | S. Vs + S. GND | S. GND       | S. GND      |
| S. GND (sk)                               | /           | S. GND      | S. Vs          | S. GND       | Open L. (*) |
| S. Vs                                     | /           | /           | S. Vs          | S. Vs        | S. Vs       |
| S. Across L.                              | /           | /           | /              | S. Across L. | N.A.        |
| Open L.                                   | /           | /           | /              | /            | Open L. (*) |

S. GND (so) / S. GND (sk) in the above table make a distinction according to which of the 2 outputs is shorted to ground (test-current source side= so, test-current sink side = sk). More precisely, in Channels LF and RR, so = CH+, sk = CH-; in Channels LR and RF, so = CH-, sk = CH+ .

In Permanent Diagnostic the table is the same, with only a difference concerning Open Load(\*) , which is not among the recognisable faults. Should an Open Load be present during the device's normal working, it would be detected at a subsequent Turn on Diagnostic cycle (i.e. at the successive Car Radio Turn on).

**FAULTS AVAILABILITY**

All the results coming from I<sup>2</sup>Cbus, by read operations, are the consequence of measurements inside a defined period of time. If the fault is stable throughout the whole period, it will be sent out.

To guarantee always resident functions, every kind of diagnostic cycles (Turn on, Permanent, Offset) will be reactivate after any I<sup>2</sup>C reading operation. So, when the micro reads the I<sup>2</sup>C, a new cycle will be able to start, but the read data will come from the previous diag. cycle (i.e. The device is in Turn On state, with a short to Gnd, then the short is removed and micro reads I<sup>2</sup>C. The short to Gnd is still present in bytes, because it is the result of the previous cycle. If another I<sup>2</sup>C reading operation occurs, the bytes do not show the short). In general to observe a change in Diagnostic bytes, two I<sup>2</sup>C reading operations are necessary.

**THERMAL PROTECTION**

Thermal protection is implemented through thermal foldback (fig. 21). Thermal foldback begins limiting the audio input to the amplifier stage as the junction temperatures rise above the normal operating range. This effectively limits the output power capability of the device thus reducing the temperature to acceptable levels without totally interrupting the operation of the device. The output power will decrease to the point at which thermal equilibrium is reached. Thermal equilibrium will be reached when the reduction in output power reduces the dissipated power such that the die temperature falls below the thermal foldback threshold. Should the device cool, the audio level will increase until a new thermal equilibrium is reached or the amplifier reaches full power. Thermal foldback will reduce the audio output level in a linear manner.



Figure 21. Thermal Foldback Diagram

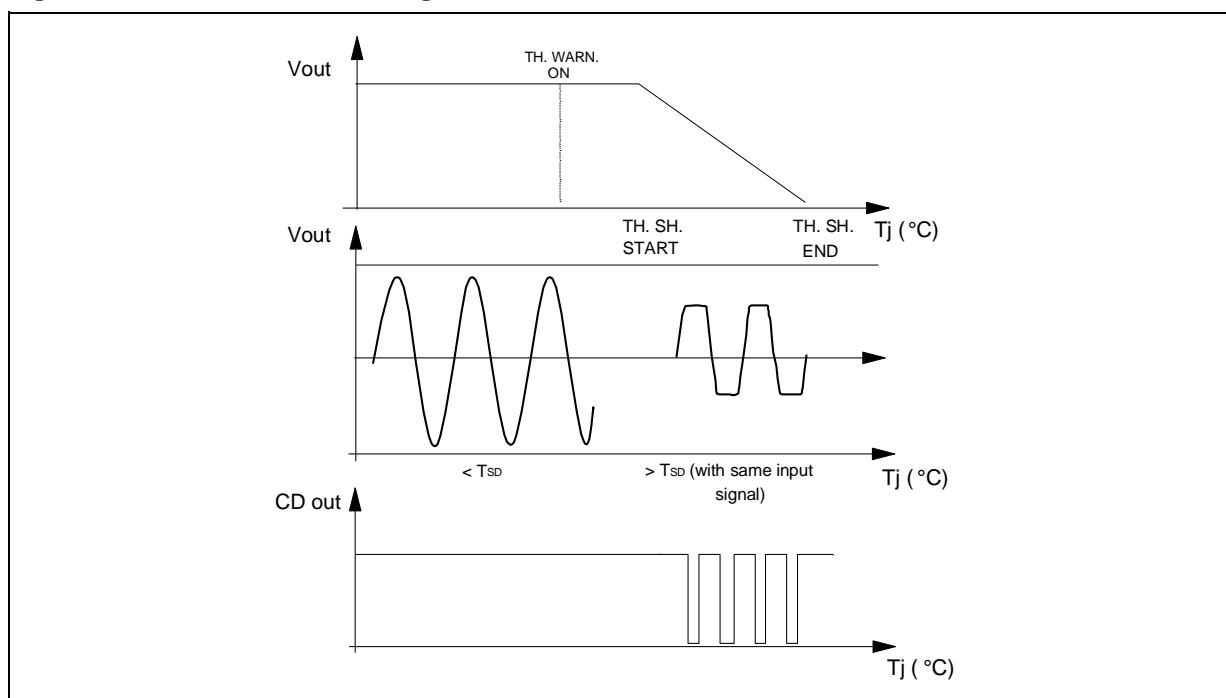

### I<sup>2</sup>C PROGRAMMING/READING SEQUENCES

A correct turn on/off sequence respectful of the diagnostic timings and producing no audible noises could be as follows (after battery connection):

TURN-ON: PIN2 > 7V --- 10ms --- (STAND-BY OUT + DIAG ENABLE) --- 500 ms (min) --- MUTING OUT

TURN-OFF: MUTING IN --- 20 ms --- (DIAG DISABLE + STAND-BY IN) --- 10ms --- PIN2 = 0

Car Radio Installation: PIN2 > 7V --- 10ms DIAG ENABLE (write) --- 200 ms --- I<sup>2</sup>C read (repeat until All faults disappear).

OFFSET TEST: Device in Play (no signal) -- OFFSET ENABLE - 30ms - I<sup>2</sup>C reading (repeat I<sup>2</sup>C reading until high-offset message disappears).

### I<sup>2</sup>C BUS INTERFACE

Data transmission from microprocessor to the TDA7563 and viceversa takes place through the 2 wires I<sup>2</sup>C BUS interface, consisting of the two lines SDA and SCL (pull-up resistors to positive supply voltage must be connected).

#### Data Validity

As shown by fig. 22, the data on the SDA line must be stable during the high period of the clock. The HIGH and LOW state of the data line can only change when the clock signal on the SCL line is LOW.

#### Start and Stop Conditions

As shown by fig. 23 a start condition is a HIGH to LOW transition of the SDA line while SCL is HIGH. The stop condition is a LOW to HIGH transition of the SDA line while SCL is HIGH.

#### Byte Format

Every byte transferred to the SDA line must contain 8 bits. Each byte must be followed by an acknowledge bit. The MSB is transferred first.

#### Acknowledge

The transmitter\* puts a resistive HIGH level on the SDA line during the acknowledge clock pulse (see fig. 24). The receiver\*\* the acknowledges has to pull-down (LOW) the SDA line during the acknowledge clock pulse, so that the SDA line is stable LOW during this clock pulse.

\* Transmitter

- master ( $\mu$ P) when it writes an address to the TDA7563
- slave (TDA7563) when the  $\mu$ P reads a data byte from TDA7563

\*\* Receiver

- slave (TDA7563) when the  $\mu$ P writes an address to the TDA7563
- master ( $\mu$ P) when it reads a data byte from TDA7563

Figure 22. Data Validity on the I<sup>2</sup>C BUS

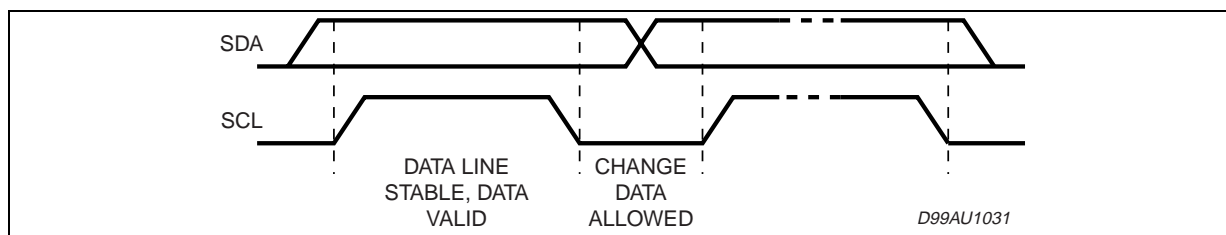

Figure 23. Timing Diagram on the I<sup>2</sup>C BUS

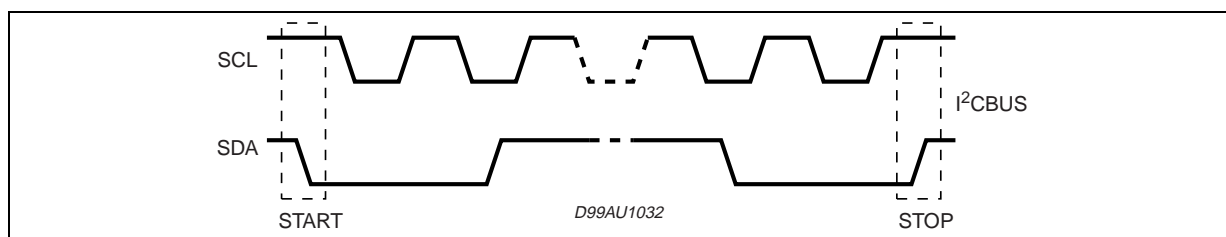
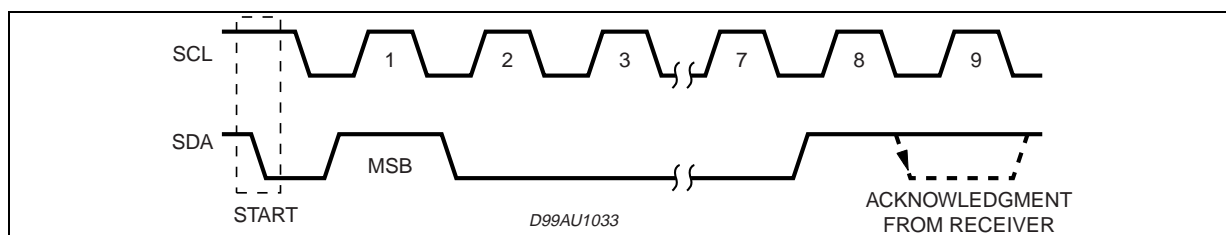

Figure 24. Acknowledge on the I<sup>2</sup>C BUS



**SOFTWARE SPECIFICATIONS**

All the functions of the TDA7563 are activated by I<sup>2</sup>C interface.

The bit 0 of the "ADDRESS BYTE" defines if the next bytes are write instruction (from  $\mu$ P to TDA7563) or read instruction (from TDA7563 to  $\mu$ P).

Chip Address:

|           |   |   |   |   |   |   |   |           |   |        |
|-----------|---|---|---|---|---|---|---|-----------|---|--------|
| <b>D7</b> | 1 | 1 | 0 | 1 | 1 | 0 | 0 | <b>D0</b> | X | D8 Hex |
|-----------|---|---|---|---|---|---|---|-----------|---|--------|

X = 0 Write to device

X = 1 Read from device

If R/W = 0, the  $\mu$ P sends 2 "Instruction Bytes": IB1 and IB2.

**IB1**

|           |  |
|-----------|--|
| <b>D7</b> | X  |
| D6        | Diagnostic enable (D6 = 1)<br>Diagnostic defeat (D6 = 0)             |
| D5        | Offset Detection enable (D5 = 1)<br>Offset Detection defeat (D5 = 0) |
| D4        | Front Channel<br>Gain = 30dB (D4 = 0)<br>Gain = 16dB (D4 = 1)        |
| D3        | Rear Channel<br>Gain = 30dB (D3 = 0)<br>Gain = 16dB (D3 = 1)         |
| D2        | Mute front channels (D2 = 0)<br>Unmute front channels (D2 = 1)       |
| D1        | Mute rear channels (D1 = 0)<br>Unmute rear channels (D1 = 1)         |
| D0        | CD 2% (D0 = 0)<br>CD 10% (D0 = 1)                                    |

**IB2**

|           |  |
|-----------|--|
| <b>D7</b> | X  |
| D6        | used for testing   |
| D5        | used for testing   |
| D4        | Stand-by on - Amplifier not working - (D4 = 0)Stand-by off - Amplifier working - (D4 = 1)                              |
| D3        | Power amplifier mode diagnostic (D3 = 0)Line driver mode diagnostic (D3 = 1)   |
| D2        | X  |
| D1        | Right ChannelPower amplifier working in standard mode (D1 = 0)Power amplifier working in high efficiency mode (D1 = 1) |
| D0        | Left ChannelPower amplifier working in standard mode (D0 = 0)Power amplifier working in high efficiency mode (D0 = 1)  |

## TDA7563

If R/W = 1, the TDA7563 sends 4 "Diagnostics Bytes" to  $\mu$ P: DB1, DB2, DB3 and DB4.

### DB1

|    |   |
|----|---|
| D7 | Thermal warning active (D7 = 1)   |
| D6 | Diag. cycle not activated or not terminated (D6 = 0)<br>Diag. cycle terminated (D6 = 1)   |
| D5 | X   |
| D4 | Channel LF<br>Turn-on diagnostic (D4 = 0)<br>Permanent diagnostic (D4 = 1)  |
| D3 | Channel LF<br>Normal load (D3 = 0)<br>Short load (D3 = 1)   |
| D2 | Channel LF<br>Turn-on diag.: No open load (D2 = 0)<br>Open load detection (D2 = 1)<br>Offset diag.: No output offset (D2 = 0)<br>Output offset detection (D2 = 1) |
| D1 | Channel LF<br>No short to Vcc (D1 = 0)<br>Short to Vcc (D1 = 1)   |
| D0 | Channel LF<br>No short to GND (D1 = 0)<br>Short to GND (D1 = 1)   |

### DB2

|    |  |
|----|--|
| D7 | Offset detection not activated (D7 = 0)<br>Offset detection activated (D7 = 1)   |
| D6 | X  |
| D5 | X  |
| D4 | Channel LR<br>Turn-on diagnostic (D4 = 0)<br>Permanent diagnostic (D4 = 1)   |
| D3 | Channel LR<br>Normal load (D3 = 0)<br>Short load (D3 = 1)  |
| D2 | Channel LR<br>Turn-on diag.: No open load (D2 = 0)<br>Open load detection (D2 = 1)<br>Permanent diag.: No output offset (D2 = 0)<br>Output offset detection (D2 = 1) |
| D1 | Channel LR<br>No short to Vcc (D1 = 0)<br>Short to Vcc (D1 = 1)  |
| D0 | Channel LR<br>No short to GND (D1 = 0)<br>Short to GND (D1 = 1)  |



**B3**

|           |  |
|-----------|--|
| <b>D7</b> | Stand-by status (= IB1 - D4)   |
| D6        | Diagnostic status (= IB1 - D6)   |
| D5        | X  |
| D4        | Channel RF<br>Turn-on diagnostic (D4 = 0)<br>Permanent diagnostic (D4 = 1)   |
| D3        | Channel RF<br>Normal load (D3 = 0)<br>Short load (D3 = 1)  |
| D2        | Channel RF<br>Turn-on diag.: No open load (D2 = 0)<br>Open load detection (D2 = 1)<br>Permanent diag.: No output offset (D2 = 0)<br>Output offset detection (D2 = 1) |
| D1        | Channel RF<br>No short to Vcc (D1 = 0)<br>Short to Vcc (D1 = 1)  |
| D0        | Channel RF<br>No short to GND (D1 = 0)<br>Short to GND (D1 = 1)  |

**DB4**

|           |  |
|-----------|--|
| <b>D7</b> | X  |
| D6        | X  |
| D5        | X  |
| D4        | Channel RR<br>Turn-on diagnostic (D4 = 0)<br>Permanent diagnostic (D4 = 1)   |
| D3        | Channel R<br>RNormal load (D3 = 0)<br>Short load (D3 = 1)  |
| D2        | Channel RR<br>Turn-on diag.: No open load (D2 = 0)<br>Open load detection (D2 = 1)<br>Permanent diag.: No output offset (D2 = 0)<br>Output offset detection (D2 = 1) |
| D1        | Channel RR<br>No short to Vcc (D1 = 0)<br>Short to Vcc (D1 = 1)  |
| D0        | Channel RR<br>No short to GND (D1 = 0)<br>Short to GND (D1 = 1)  |

**Examples of bytes sequence**

**1 - Turn-On diagnostic - Write operation**

|       |                          |     |                 |     |     |     |      |
|-------|--------------------------|-----|-----------------|-----|-----|-----|------|
| Start | Address byte with D0 = 0 | ACK | IB1 with D6 = 1 | ACK | IB2 | ACK | STOP |
|-------|--------------------------|-----|-----------------|-----|-----|-----|------|

**2 - Turn-On diagnostic - Read operation**

|       |                          |     |     |     |     |     |     |     |     |     |      |
|-------|--------------------------|-----|-----|-----|-----|-----|-----|-----|-----|-----|------|
| Start | Address byte with D0 = 1 | ACK | DB1 | ACK | DB2 | ACK | DB3 | ACK | DB4 | ACK | STOP |
|-------|--------------------------|-----|-----|-----|-----|-----|-----|-----|-----|-----|------|

The delay from 1 to 2 can be selected by software, starting from T.B.D. ms

**3a - Turn-On of the power amplifier with 30dB gain, mute on, diagnostic defeat, CD = 2%.**

|       |                          |     |          |     |          |     |      |
|-------|--------------------------|-----|----------|-----|----------|-----|------|
| Start | Address byte with D0 = 0 | ACK | IB1      | ACK | IB2      | ACK | STOP |
|       |                          |     | X0000000 |     | XXX1XX11 |     |      |

**3b - Turn-Off of the power amplifier**

|       |                          |     |          |     |          |     |      |
|-------|--------------------------|-----|----------|-----|----------|-----|------|
| Start | Address byte with D0 = 0 | ACK | IB1      | ACK | IB2      | ACK | STOP |
|       |                          |     | X0XXXXXX |     | XXX0XXXX |     |      |

**4 - Offset detection procedure enable**

|       |                          |     |          |     |          |     |      |
|-------|--------------------------|-----|----------|-----|----------|-----|------|
| Start | Address byte with D0 = 0 | ACK | IB1      | ACK | IB2      | ACK | STOP |
|       |                          |     | XX1XX11X |     | XXX1XXXX |     |      |

**5 - Offset detection procedure stop and reading operation (the results are valid only for the offset detection bits (D2 of the bytes DB1, DB2, DB3, DB4).**

|       |                          |     |     |     |     |     |     |     |     |     |      |
|-------|--------------------------|-----|-----|-----|-----|-----|-----|-----|-----|-----|------|
| Start | Address byte with D0 = 1 | ACK | DB1 | ACK | DB2 | ACK | DB3 | ACK | DB4 | ACK | STOP |
|-------|--------------------------|-----|-----|-----|-----|-----|-----|-----|-----|-----|------|

- The purpose of this test is to check if a D.C. offset (2V typ.) is present on the outputs, produced by input capacitor with anomalous leakage current or humidity between pins.
- The delay from 4 to 5 can be selected by software, starting from T.B.D. ms

| DIM.   | mm    |       |            | inch  |       |       |
|--------|-------|-------|------------|-------|-------|-------|
|        | MIN.  | TYP.  | MAX.       | MIN.  | TYP.  | MAX.  |
| A      | 4.45  | 4.50  | 4.65       | 0.175 | 0.177 | 0.183 |
| B      | 1.80  | 1.90  | 2.00       | 0.070 | 0.074 | 0.079 |
| C      |       | 1.40  |            |       | 0.055 |       |
| D      | 0.75  | 0.90  | 1.05       | 0.029 | 0.035 | 0.041 |
| E      | 0.37  | 0.39  | 0.42       | 0.014 | 0.015 | 0.016 |
| F (1)  |       |       | 0.57       |       |       | 0.022 |
| G      | 0.80  | 1.00  | 1.20       | 0.031 | 0.040 | 0.047 |
| G1     | 25.75 | 26.00 | 26.25      | 1.014 | 1.023 | 1.033 |
| H (2)  | 28.90 | 29.23 | 29.30      | 1.139 | 1.150 | 1.153 |
| H1     |       | 17.00 |            |       | 0.669 |       |
| H2     |       | 12.80 |            |       | 0.503 |       |
| H3     |       | 0.80  |            |       | 0.031 |       |
| L (2)  | 22.07 | 22.47 | 22.87      | 0.869 | 0.884 | 0.904 |
| L1     | 18.57 | 18.97 | 19.37      | 0.731 | 0.747 | 0.762 |
| L2 (2) | 15.50 | 15.70 | 15.90      | 0.610 | 0.618 | 0.626 |
| L3     | 7.70  | 7.85  | 7.95       | 0.303 | 0.309 | 0.313 |
| L4     |       | 5     |            |       | 0.197 |       |
| L5     |       | 3.5   |            |       | 0.138 |       |
| M      | 3.70  | 4.00  | 4.30       | 0.145 | 0.157 | 0.169 |
| M1     | 3.60  | 4.00  | 4.40       | 0.142 | 0.157 | 0.173 |
| N      |       | 2.20  |            |       | 0.086 |       |
| O      |       | 2     |            |       | 0.079 |       |
| R      |       | 1.70  |            |       | 0.067 |       |
| R1     |       | 0.5   |            |       | 0.02  |       |
| R2     |       | 0.3   |            |       | 0.12  |       |
| R3     |       | 1.25  |            |       | 0.049 |       |
| R4     |       | 0.50  |            |       | 0.019 |       |
| V      |       |       | 5° (Typ.)  |       |       |       |
| V1     |       |       | 3° (Typ.)  |       |       |       |
| V2     |       |       | 20° (Typ.) |       |       |       |
| V3     |       |       | 45° (Typ.) |       |       |       |

(1): dam-bar protusion not included  
 (2): molding protusion included

**OUTLINE AND MECHANICAL DATA**

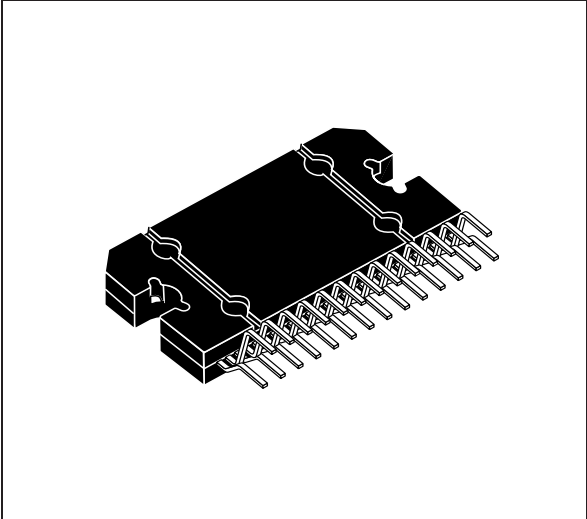

**Flexiwatt27 (vertical)**

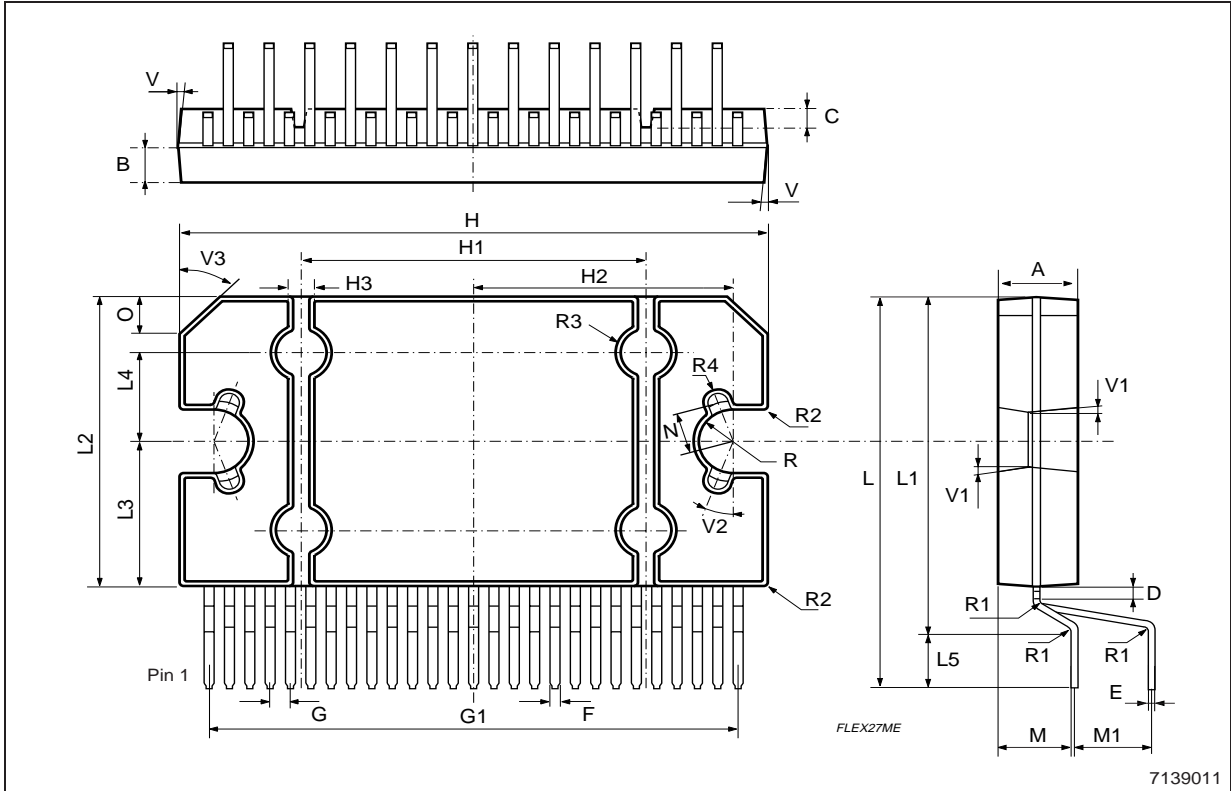

7139011

Information furnished is believed to be accurate and reliable. However, STMicroelectronics assumes no responsibility for the consequences of use of such information nor for any infringement of patents or other rights of third parties which may result from its use. No license is granted by implication or otherwise under any patent or patent rights of STMicroelectronics. Specifications mentioned in this publication are subject to change without notice. This publication supersedes and replaces all information previously supplied. STMicroelectronics products are not authorized for use as critical components in life support devices or systems without express written approval of STMicroelectronics.

The ST logo is a registered trademark of STMicroelectronics  
© 2003 STMicroelectronics - All Rights Reserved

STMicroelectronics GROUP OF COMPANIES  
Australia - Brazil - Canada - China - Finland - France - Germany - Hong Kong - India - Israel - Italy - Japan -Malaysia - Malta - Morocco -  
Singapore - Spain - Sweden - Switzerland - United Kingdom - United States.  
<http://www.st.com>