

Features

- Epitaxial Planar Die Construction
- Complementary PNP Types Available (DDTA)
- Built-In Biasing Resistors, R1≠R2
- Also Available in Lead Free Version

Mechanical Data

- Case: SOT-523, Molded Plastic
- Case material - UL Flammability Rating 94V-0
- Moisture sensitivity: Level 1 per J-STD-020A
- Terminals: Solderable per MIL-STD-202, Method 208
- Also Available in Lead Free Plating (Matte Tin Finish). Please see Ordering Information, Note 3, on Page 2
- Terminal Connections: See Diagram
- Marking: Date Code and Marking Code (See Diagrams & Page 3)
- Weight: 0.002 grams (approx.)
- Ordering Information (See Page 2)

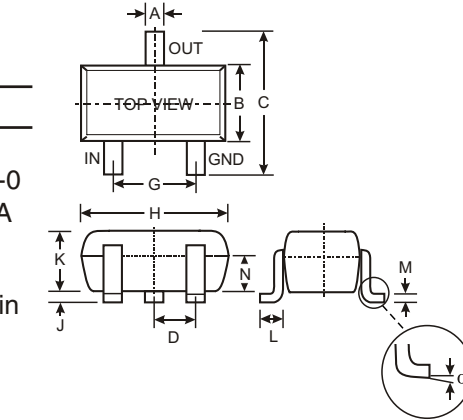

SOT-523			
Dim	Min	Max	Typ
A	0.15	0.30	0.22
B	0.75	0.85	0.80
C	1.45	1.75	1.60
D	—	—	0.50
G	0.90	1.10	1.00
H	1.50	1.70	1.60
J	0.00	0.10	0.05
K	0.60	0.80	0.75
L	0.10	0.30	0.22
M	0.10	0.20	0.12
N	0.45	0.65	0.50
α	0°	8°	—
All Dimensions in mm			

P/N	R1 (NOM)	R2 (NOM)	MARKING
DDTC113ZE	1K Ω	10K Ω	N02
DDTC123YE	2.2K Ω	10K Ω	N05
DDTC123JE	2.2K Ω	47K Ω	N06
DDTC143XE	4.7K Ω	10K Ω	N09
DDTC143FE	4.7K Ω	22K Ω	N10
DDTC143ZE	4.7K Ω	47K Ω	N11
DDTC114YE	10K Ω	47K Ω	N14
DDTC114WE	10K Ω	4.7K Ω	N15
DDTC124XE	22K Ω	47K Ω	N18
DDTC144VE	47K Ω	10K Ω	N21
DDTC144WE	47K Ω	22K Ω	N22

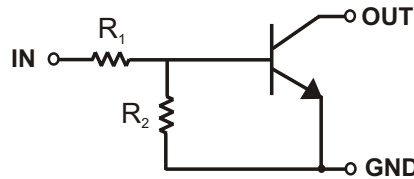

SCHEMATIC DIAGRAM

Maximum Ratings @ T_A = 25°C unless otherwise specified

Characteristic	Symbol	Value	Unit
Supply Voltage, (3) to (1)	V _{CC}	50	V
Input Voltage, (2) to (1)	V _{IN}	-5 to +10 -5 to +12 -5 to +12 -7 to +20 -6 to +30 -5 to +30 -6 to +40 -10 to +30 -10 to +40 -15 to +40 -10 to +40	V
Output Current	I _O	100 100 100 100 100 100 70 100 50 30 30	mA
Output Current	I _C (Max)	100	mA
Power Dissipation	P _d	150	mW
Thermal Resistance, Junction to Ambient Air (Note 1)	R _{θJA}	833	°C/W
Operating and Storage and Temperature Range	T _J , T _{STG}	-55 to +150	°C

Note: 1. Mounted on FR4 PC Board with recommended pad layout at <http://www.diodes.com/datasheets/ap02001.pdf>.

Electrical Characteristics @ T_A = 25°C unless otherwise specified

Characteristic		Symbol	Min	Typ	Max	Unit	Test Condition
Input Voltage	DDTC113ZE DDTC123YE DDTC123JE DDTC143XE DDTC143FE DDTC143ZE DDTC114YE DDTC114WE DDTC124XE DDTC144VE DDTC144WE	V _{I(off)}	0.3 0.3 0.5 0.3 0.3 0.5 0.3 0.8 0.4 1.0 0.8	—	—	V	V _{CC} = 5V, I _O = 100μA
	DDTC113ZE DDTC123YE DDTC123JE DDTC143XE DDTC143FE DDTC143ZE DDTC114YE DDTC114WE DDTC124XE DDTC144VE DDTC144WE		V _{I(on)}	—	—		
Output Voltage		V _{O(on)}	—	0.1	0.3	V	I _O /I _I = 5mA/0.25mA DDCT123JE I _O /I _I = 5mA/0.25mA DDCT143ZE I _O /I _I = 5mA/0.25mA DDCT114YE I _O /I _I = 10mA/0.5mA All Others
Input Current	DDTC113ZE DDTC123YE DDTC123JE DDTC143XE DDTC143FE DDTC143ZE DDTC114YE DDTC114WE DDTC124XE DDTC144VE DDTC144WE	I _I	—	—	7.2 3.8 3.6 1.8 1.8 1.8 0.88 0.88 0.36 0.16 0.16	mA	V _I = 5V
Output Current		I _{O(off)}	—	—	0.5	μA	V _{CC} = 50V, V _I = 0V
DC Current Gain	DDTC113ZE DDTC123YE DDTC123JE DDTC143XE DDTC143FE DDTC143ZE DDTC114YE DDTC114WE DDTC124XE DDTC144VE DDTC144WE	G _I	33 33 80 30 68 80 68 24 68 33 56	—	—	—	V _O = 5V, I _O = 5mA V _O = 5V, I _O = 10mA V _O = 5V, I _O = 10mA V _O = 5V, I _O = 10mA V _O = 5V, I _O = 10mA V _O = 5V, I _O = 10mA V _O = 5V, I _O = 5mA V _O = 5V, I _O = 10mA V _O = 5V, I _O = 5mA V _O = 5V, I _O = 5mA V _O = 5V, I _O = 5mA
Input Resistor Tolerance		ΔR ₁	-30	—	+30	%	—
Resistance Ratio Tolerance		ΔR ₂ /R ₁	-20	—	+20	%	—
Gain-Bandwidth Product*		f _T	—	250	—	MHz	V _{CE} = 10V, I _E = 5mA, f = 100MHz

* Transistor - For Reference Only

Ordering Information (Note 2)

Device	Packaging	Shipping
DDTC113ZE-7	SOT-523	3000/Tape & Reel
DDTC123YE-7	SOT-523	3000/Tape & Reel
DDTC123JE-7	SOT-523	3000/Tape & Reel
DDTC143XE-7	SOT-523	3000/Tape & Reel
DDTC143FE-7	SOT-523	3000/Tape & Reel
DDTC143ZE-7	SOT-523	3000/Tape & Reel
DDTC114YE-7	SOT-523	3000/Tape & Reel
DDTC114WE-7	SOT-523	3000/Tape & Reel
DDTC124XE-7	SOT-523	3000/Tape & Reel
DDTC144VE-7	SOT-523	3000/Tape & Reel
DDTC144WE-7	SOT-523	3000/Tape & Reel

- Notes: 2. For Packaging Details, go to our website at <http://www.diodes.com/datasheets/ap02007.pdf>.
3. For Lead Free version (with Lead Free terminal finish) part number, please add "-F" suffix to part number above.
Example: DDTC144WE-7-F.

Marking Information

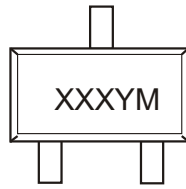

XXX = Product Type Marking Code (See Page 1, e.g. N02 = DDTC113ZE)
 YM = Date Code Marking
 Y = Year ex: N = 2002
 M = Month ex: 9 = September

Date Code Key

Year	2002	2003	2004	2005	2006	2007	2008	2009
Code	N	P	R	S	T	U	V	W

Month	Jan	Feb	March	Apr	May	Jun	Jul	Aug	Sep	Oct	Nov	Dec
Code	1	2	3	4	5	6	7	8	9	O	N	D

TYPICAL CURVES - DDTC123JE

NEW PRODUCT

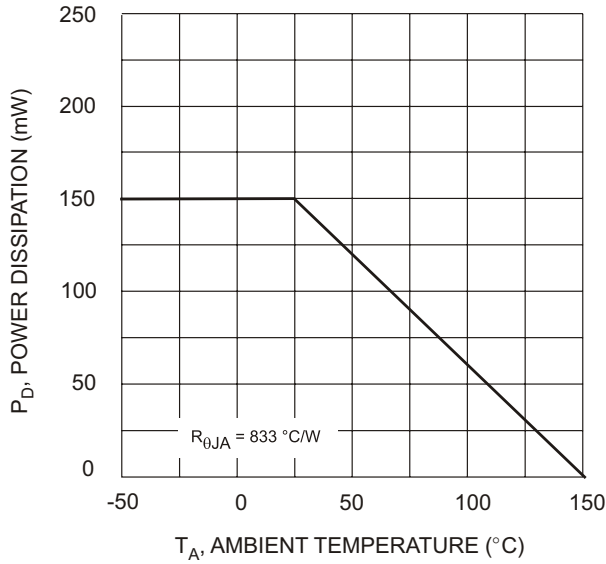

Fig. 1 Derating Curve

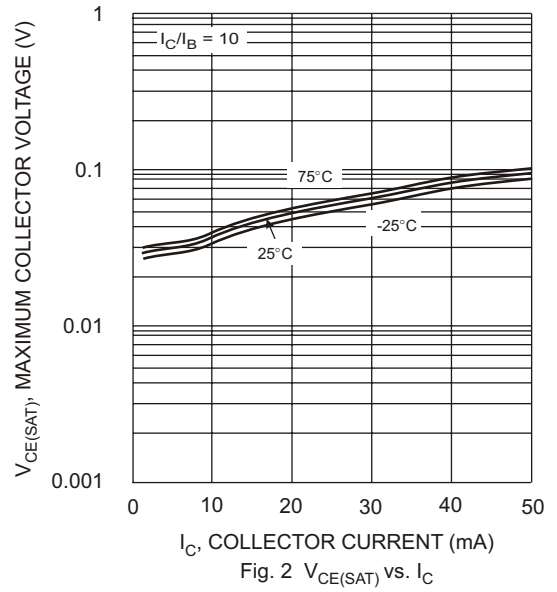

Fig. 2 $V_{CE(SAT)}$ vs. I_C

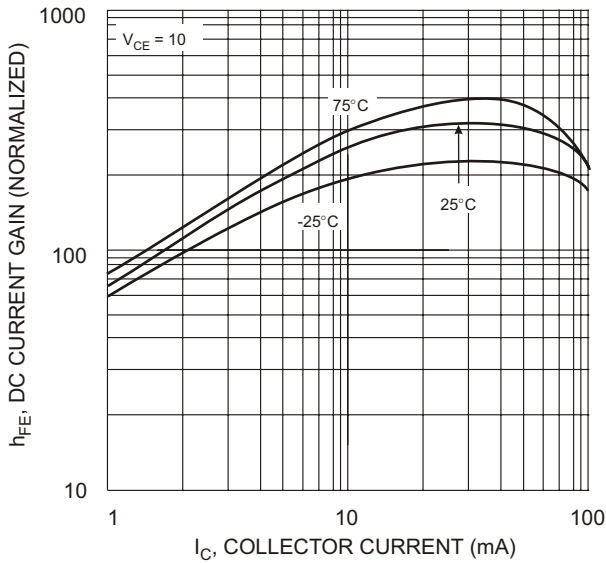

Fig. 3 DC Current Gain

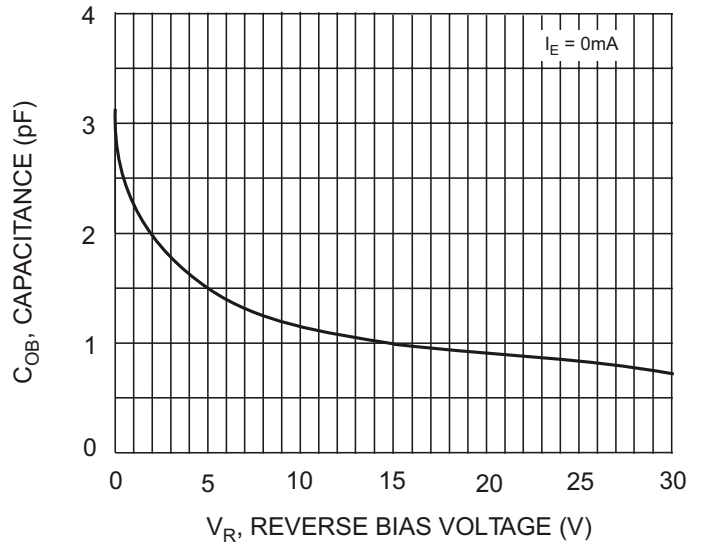

Fig. 4 Output Capacitance

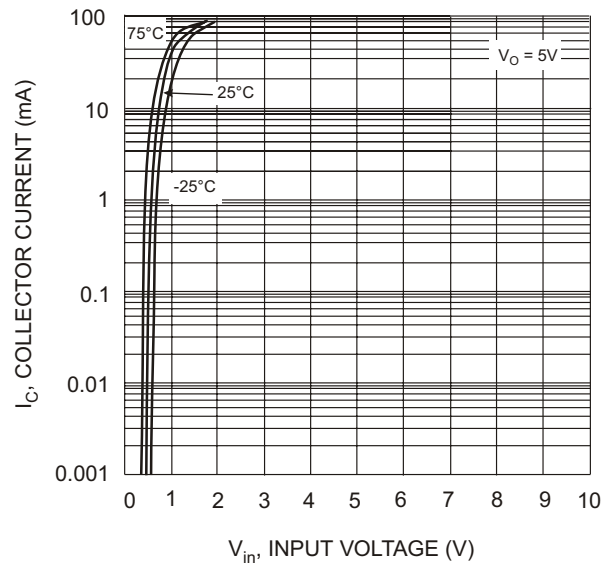

Fig. 5 Collector Current Vs. Input Voltage

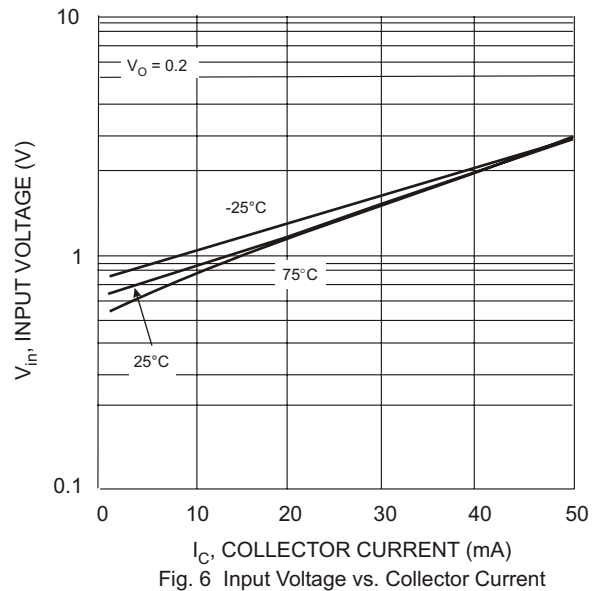

Fig. 6 Input Voltage vs. Collector Current