

SONY**CXA1522P/M/N****Stereo Power Amplifier****Description**

The CXA1522P/M/N is a bipolar integrated circuit designed for power amplifiers of small-sized radio-cassette tape recorders. Included is a pre-amplifier, power amplifier, and an electrical volume control.

Features

- CXA1522P: EIAJ output = 500mW (typ.),
 $V_{CC} = 6V, R_L = 8\Omega$
- CXA1522M: EIAJ output = 110mW (typ.),
 $V_{CC} = 3V, R_L = 8\Omega$
- CXA1522N: EIAJ output = 95mW (typ.),
 $V_{CC} = 3V, R_L = 8\Omega$
- Built-in electronic volume control
- Built-in ripple filter (ripple rejection 34.5 dB typ.)

Applications

Ideal for use as a stereo radio power amplifier or a radio-cassette tape recorder/Walkman-type cassette tape player power amplifier.

Structure

Bipolar silicon monolithic IC

Absolute Maximum Ratings

• Supply voltage	V_{CC}	8	V
• Operating temperature	T_{opr}	-10 to +60	°C
• Storage temperature	T_{stg}	-65 to +150	°C
• Allowable power dissipation	P_D	1200	mW (CXA1522P)
		410	mW (CXA1522M)
		350	mW (CXA1522N)

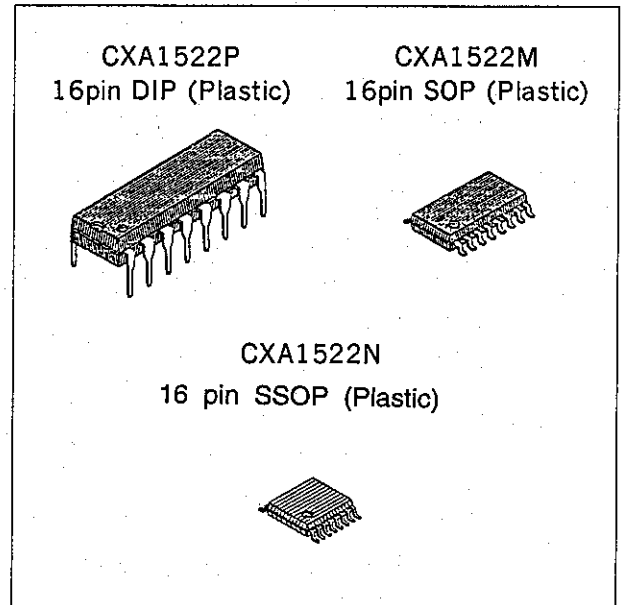
**Operating Conditions**

- Supply voltage 1.8 to 7.0 V (CXA1522P)
1.8 to 4.5 V (CXA1522M,
CXA1522N)

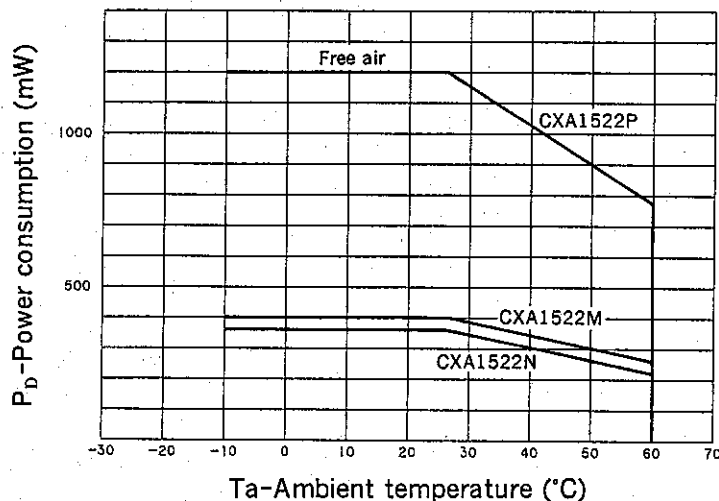
Power Dissipation Gradual Decrease Curve

- 1 -

Sony reserves the right to change products and specifications without prior notice. This information does not convey any license by any implication or otherwise under any patents or other right. Application circuits shown, if any, are typical examples illustrating the operation of the devices. Sony cannot assume responsibility for any problems arising out of the use of these circuits.

E91857D33

Block Diagram, Pin Configuration and Application Circuit

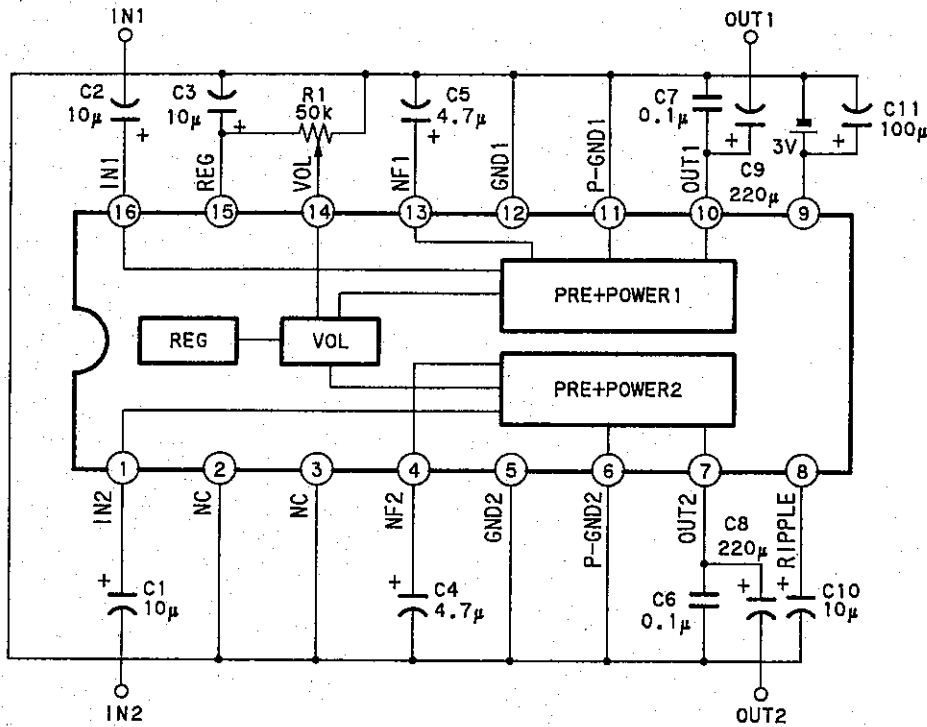

Application circuits shown are typical examples illustrating the operation of the devices. Sony cannot assume responsibility for any problems arising out of the use of these circuits or for any infringement of third party patent and other right due to same.

Pin 14 DC causes the input signal to enter the preamplifier that controls the amount of attenuation. The power amplifier amplifies the signal output from the preamplifier by approximately 30dB (fixed) and generates the output.

Pin Description

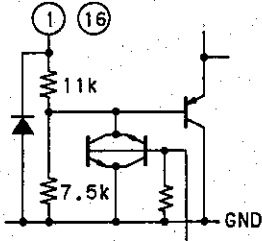
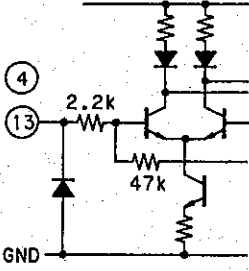
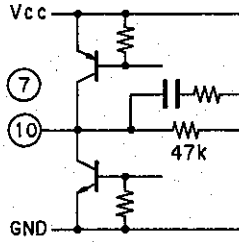
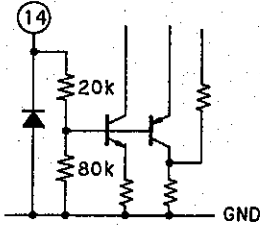
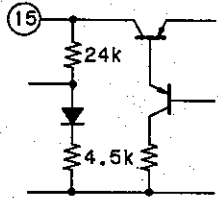
Pin No.	Symbol	Equivalent circuit	Pin voltage		Description
			3V	6V	
1, 16	IN1 IN2		0	0	Input pins
2, 3	NC		—	—	To be connected to the GND pin.
4, 13	NF1 NF2		1.5	3	Power amplifier NF pins A 4.7μF time constant is provided
5, 12	GND1 GND2		0	0	Preamplifier GND pins
6, 11	P-GND1 P-GND2		0	0	Power amplifier GND pins
7, 10	OUT1 OUT2		1.5	3	Power amplifier output pins
9	V _{CC}		3	6	V _{CC}
14	VOL		0 to 1.25	0 to 1.25	Electronic volume control pin The voltage is varied from 0 to 1.25V to change the gain
15	REG		1.25	1.25	Regulator pin

Electrical Characteristics

(Ta = 25°C; V_{CC} = 6V [CXA1552P, upper line], 3V [CXA1522M, middle line], 3V [CXA1522N, lower line])

No.	Test items	SW conditions										Test point	Description of output waveform and test method	Min.	Typ.	Max.	Unit			
		SW1	SW2	SW3	SW4	SW5	SW6	SW7	SW8	SW9	SW10									
1	Circuit current	ON	OFF	OFF	OFF	OFF	OFF	OFF	OFF	OFF	OFF	OFF	I _o	Circuit current in no-signal state	— — —	3.0 2.5 2.5	5.0 4.0 4.0	mA		
2	Audio voltage gain (L)	OFF	↓					ON					↓	V _D	V _I = -30dBm, 1kHz	33.0 31.0 31.0	34.6 31.8 31.8	37.0 33.0 33.0	dB	
3	Audio voltage gain (R)		ON					↓	↓				ON	V _D	V _I = -30dBm, 1kHz	33.0 31.0 31.0	34.6 31.8 31.8	37.0 33.0 33.0	dB	
4	Attenuation (L)		OFF				ON	OFF					OFF	V _D	V _I = -30dBm, 1kHz Output difference between the maximum and center volume control settings	3.0 6.0 6.0	11.4 16.8 16.8	27.0 22.0 22.0	dB	
5	Attenuation (R)		ON				↓	↓					ON	V _D	V _I = -30dBm, 1kHz Output difference between the maximum and center volume control settings	3.0 6.0 6.0	11.4 16.8 16.8	27.0 22.0 22.0	dB	
6	EIAJ output (L)		OFF				OFF	ON					OFF	ON	V _D	V _I = -20dBm, 1kHz R _L = 8Ω THD = 10% Output level at which the above conditions prevail	400 100 85	500 110 95	— — —	mW
7	EIAJ output (R)		ON										ON	V _D	V _I = -20dBm, 1kHz R _L = 8Ω THD = 10% Output level at which the above conditions prevail	400 100 85	500 110 95	— — —	mW	
8	Channel balance		↓										↓	V _D	Balance between the L and R channels	-3	0	3	dB	
9	Audio distortion factor (L)		OFF										OFF	V _D	V _I = -20dBm, 1kHz Distortion factor at an output level of 50mW	— — —	0.6 0.6 0.9	2.5 2.5 2.5	%	
10	Audio distortion factor (R)		ON										ON	V _D	V _I = -20dBm, 1kHz Distortion factor at an output level of 50mW .	— — —	0.6 0.6 0.9	2.5 2.5 2.5	%	
11	Residual noise level (L)		OFF										OFF	OFF	V _D	No-signal state noise level at the maximum volume control setting	—	-66	-60	dBm
12	Residual noise level (R)		ON										ON	V _D	No-signal state noise level at the maximum volume control setting	—	-66	-60	dBm	

- 4 -

Frequency Characteristics

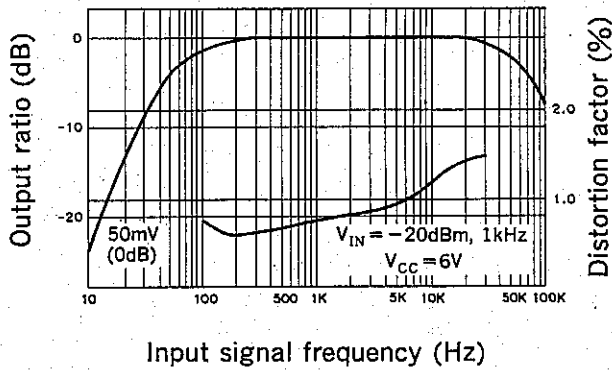

Output vs. Distortion Factor

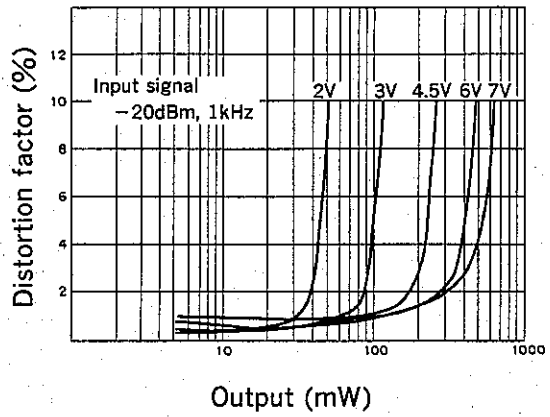

Input vs. Output Characteristics

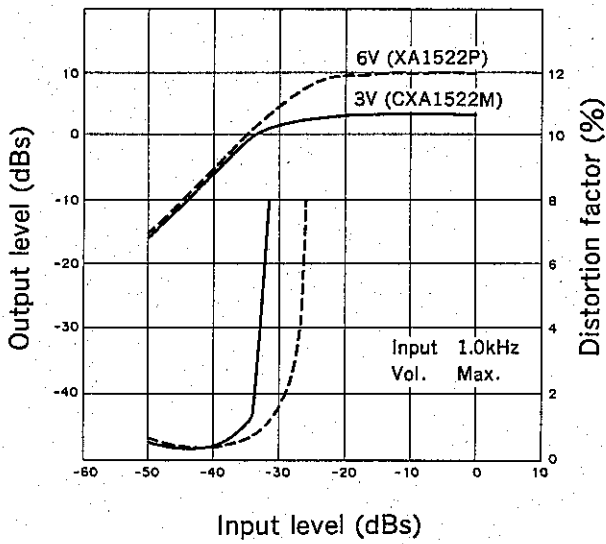

Output vs. Supply Current

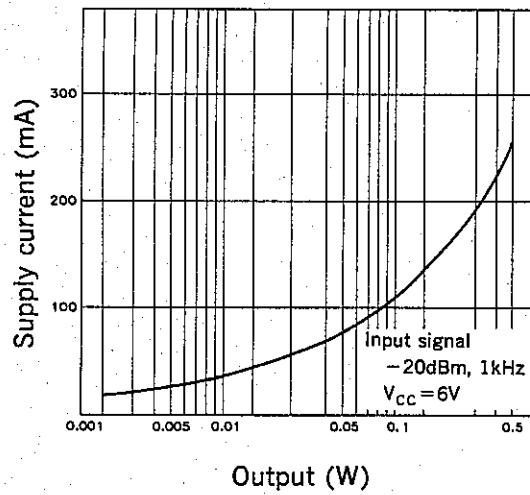

Package Outline Unit:mm

CXA1522P

16PIN DIP (PLASTIC)

Kokubu/SCT Ass'y

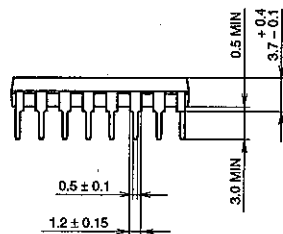
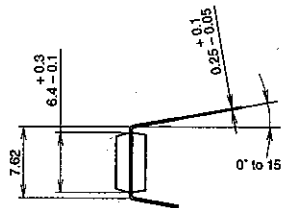
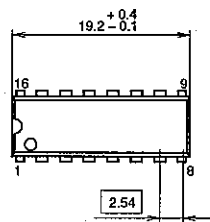

Two kinds of package surface:
 1. All mat surface type.
 2. All mirror surface type.

PACKAGE STRUCTURE

SONY CODE	DIP-16P-01
EIAJ CODE	DIP016-P-0300
JEDEC CODE	Similar to MO-001-AE

PACKAGE MATERIAL	EPOXY RESIN
LEAD TREATMENT	SOLDER PLATING
LEAD MATERIAL	COPPER ALLOY
PACKAGE MASS	1.0 g

SCT Ass'y

16PIN DIP (PLASTIC)

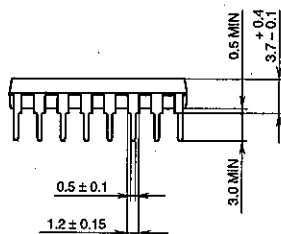
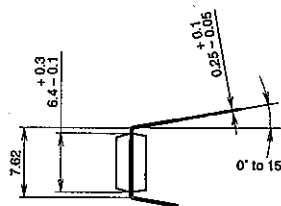
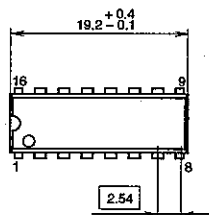

Two kinds of package surface:
 1. All mat surface type.
 2. All mirror surface type.

PACKAGE STRUCTURE

SONY CODE	DIP-16P-01
EIAJ CODE	DIP016-P-0300
JEDEC CODE	Similar to MO-001-AE

PACKAGE MATERIAL	EPOXY RESIN
LEAD TREATMENT	SOLDER PLATING
LEAD MATERIAL	COPPER ALLOY
PACKAGE MASS	1.0 g

LEAD PLATING SPECIFICATIONS

ITEM	SPEC.
LEAD MATERIAL	COPPER ALLOY
SOLDER COMPOSITION	Sn-Bi Bi:1-4wt%
PLATING THICKNESS	5-18µm

CXA1522M

16PIN SOP (PLASTIC)

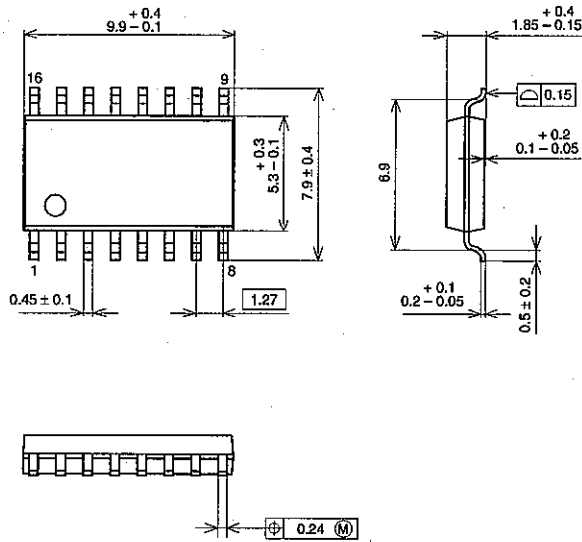

PACKAGE STRUCTURE

SONY CODE	SOP-16P-L01
EIAJ CODE	SOP016-P-0300
JEDEC CODE	

PACKAGE MATERIAL	EPOXY RESIN
LEAD TREATMENT	SOLDER PLATING
LEAD MATERIAL	COPPER ALLOY
PACKAGE MASS	0.2g

16PIN SOP (PLASTIC)

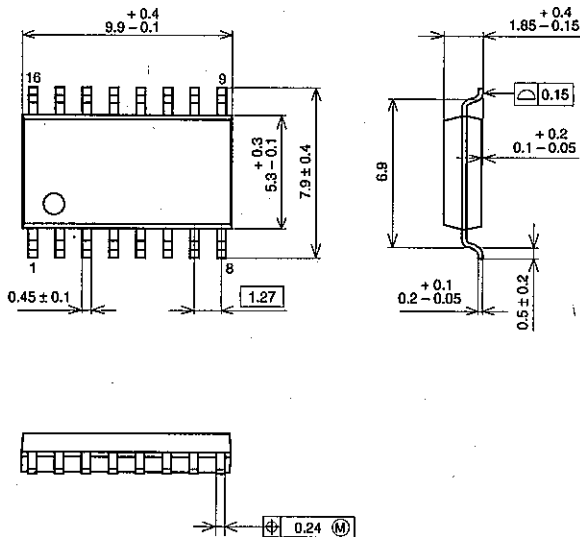

PACKAGE STRUCTURE

SONY CODE	SOP-16P-L01
EIAJ CODE	SOP016-P-0300
JEDEC CODE	

PACKAGE MATERIAL	EPOXY RESIN
LEAD TREATMENT	SOLDER PLATING
LEAD MATERIAL	COPPER ALLOY
PACKAGE MASS	0.2g

LEAD PLATING SPECIFICATIONS

ITEM	SPEC.
LEAD MATERIAL	COPPER ALLOY
SOLDER COMPOSITION	Sn-Bi Bi:1-4wt%
PLATING THICKNESS	5-18µm

CXA1522N

16PIN SSOP (PLASTIC)

Kokubu/SCT Ass'y

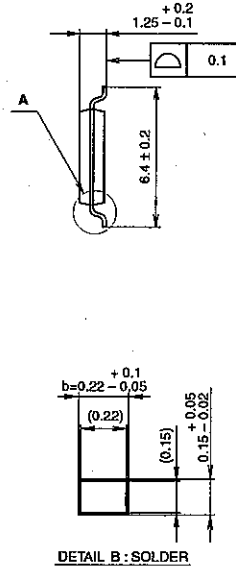
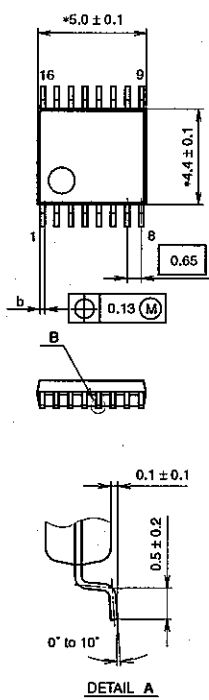

NOTE: Dimension "*" does not include mold protrusion.

PACKAGE STRUCTURE

SONY CODE	SSOP-16P-L01
EIAJ CODE	SSOP16-P-0044
JEDEC CODE	

PACKAGE MATERIAL	EPOXY RESIN
LEAD TREATMENT	SOLDER PLATING
LEAD MATERIAL	42/COPPER ALLOY
PACKAGE MASS	0.1g

SCT Ass'y

16PIN SSOP (PLASTIC)

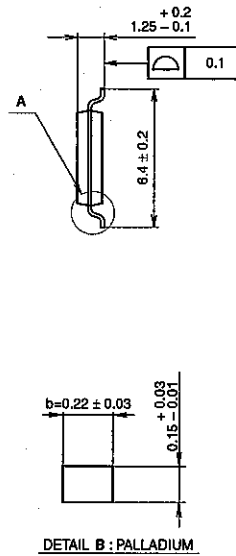
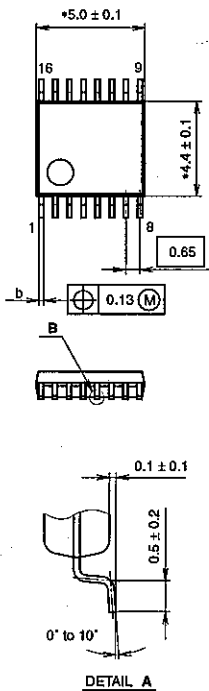

NOTE: Dimension "*" does not include mold protrusion.

PACKAGE STRUCTURE

SONY CODE	SSOP-16P-L01
EIAJ CODE	P-SSOP16-4.4x5.0-0.65
JEDEC CODE	

PACKAGE MATERIAL	EPOXY RESIN
LEAD TREATMENT	PALLADIUM PLATING
LEAD MATERIAL	COPPER ALLOY
PACKAGE MASS	0.1g