

PLEASE CHECK WWW.MOLEX.COM FOR LATEST PART INFORMATION

Part Number: [0524181410](#)
Status: **Active**
Description: 2.00mm (.079") Pitch Board-to-Board Receptacle, Right Angle, Single Row, Friction Lock, 14 Circuits

Documents:

[3D Model](#)
[Drawing \(PDF\)](#)
[Product Specification PS-52418-002 \(PDF\)](#)
[Product Specification PS-52418-003 \(PDF\)](#)
[RoHS Certificate of Compliance \(PDF\)](#)

General

Product Family PCB Receptacles
 Series [52418](#)
 Application Board-to-Board
 Product Name N/A

Physical

Circuits (Loaded) 14
 Color - Resin Natural
 Durability (mating cycles max) 30
 Glow-Wire Compliant No
 Material - Metal Phosphor Bronze
 Material - Plating Mating Tin
 Material - Plating Termination Tin
 Material - Resin Polyester
 Number of Rows 1
 Orientation Right Angle
 PCB Locator No
 PCB Retention Yes
 PCB Thickness Recommended (in) 0.062 In
 PCB Thickness Recommended (mm) 1.60 mm
 Packaging Type Tray
 Pitch - Mating Interface (in) 0.079 In
 Pitch - Mating Interface (mm) 2.00 mm
 Plating min: Mating (µin) 36
 Plating min: Mating (µm) 0.90
 Plating min: Termination (µin) 36
 Plating min: Termination (µm) 0.90
 Polarized to PCB No
 Surface Mount Compatible (SMC) No
 Temperature Range - Operating -40°C to +105°C
 Termination Interface: Style Through Hole - Kinked Pin

Electrical

Current - Maximum per Contact 1.5A
 Voltage - Maximum 125V

Material Info

Reference - Drawing Numbers

Product Specification PS-52418-002, PS-52418-003, RPS-52418-001, RPS-52418-004
 Sales Drawing SD-52418-**10

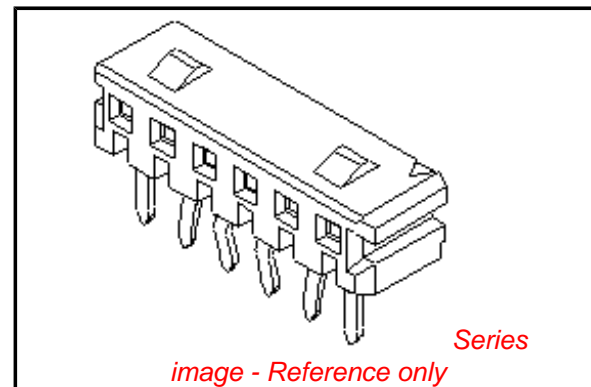

image - Reference only

EU RoHS

ELV and RoHS Compliant
REACH SVHC Contains SVHC: No
Halogen-Free Status
Not Reviewed

China RoHS



Need more information on product environmental compliance?

Email productcompliance@molex.com
 For a multiple part number RoHS Certificate of Compliance, [click here](#)

Please visit the [Contact Us](#) section for any non-product compliance questions.

Search Parts in this Series

[52418Series](#)

Mates With

[53290](#)

PLEASE CHECK WWW.MOLEX.COM FOR LATEST PART INFORMATION

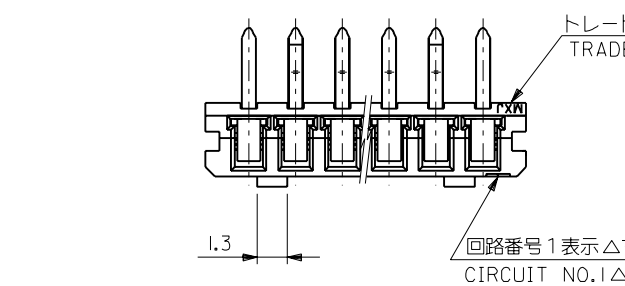
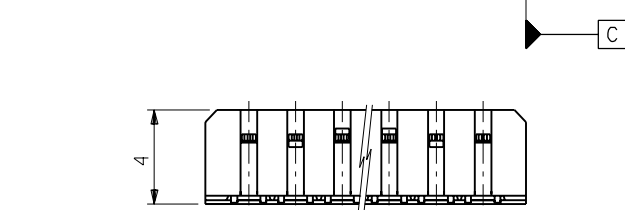
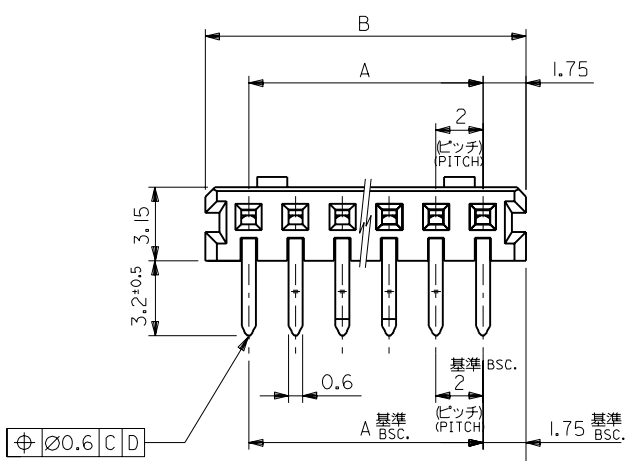

注記 NOTES

- 材料 MATERIAL
ハウジング: PBT (ガラス15%入り), UL 94V-0
HOUSING G.F. 15%
ターミナル: リン青銅, 錫メッキ
TERMINAL PHOS.BRO. PRE-TINNED
- 嵌合相手: 53290-***10, -***20
MATES WITH
- 各部のソリは0.2MAX.
CAMBER: 0.2MAX.
キックは、下記表の位置に付加。
KINK TO BE APPLIED AS FOLLOWS.
(N: 極数 CKT.)

極数 CKT.	回路番号 Ckt. No.	1	2	3	4	5	N-2	N-1	N
6極以上 MORE THAN 6 CKT.		-	a	b	-	-	b	a	-
5極 5 CKT.		a	b	-	b	a			
4極 4 CKT.		a	b	b	a				
3極 3 CKT.		a	b	a					

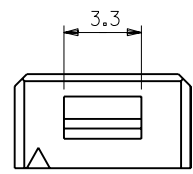
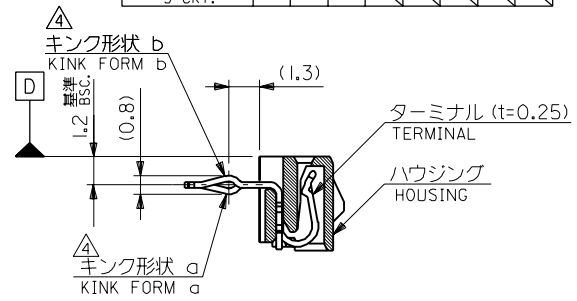

3極の場合
IN CASE OF
3 CIRCUIT HOUSING

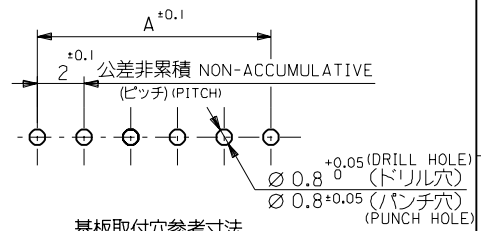

基板取付穴参考寸法
RECOMMENDED P.C.B. BOARD
HOLE DIM.(REFERENCE)
(t = 1.6)

41.5	38	52418-2010	20
39.5	36	-1910	19
37.5	34	-1810	18
35.5	32	-1710	17
33.5	30	-1610	16
31.5	28	-1510	15
29.5	26	-1410	14
27.5	24	-1310	13
25.5	22	-1210	12
23.5	20	-1110	11
21.5	18	-1010	10
19.5	16	-0910	9
17.5	14	-0810	8
15.5	12	-0710	7
13.5	10	-0610	6
11.5	8	-0510	5
9.5	6	-0410	4
7.5	4	52418-0310	3
B	A	ENG. NO.	極数 CKT.

角度 ANGLE	±3°	B	変更 REVISED (J10812)	T.I.	'91/9/27	適用電線範囲 WIRE RANGE	— // —
30以上 OVER	+0.3	A	変更 REVISED (J00866)	T.I.	'90/8/21	被覆外径 INS. RANGE	— // —
10以上 30未満 OVER	+0.25	O	新規作成 RELEASED (J00558)	S.A.	'90/7/12		
10未満 UNDER	+0.2	記号 LTR	変更内容 REVISION RECORD	DR. CHK.	日付 DATE		
一般公差 GENERAL TOLERANCES		REVISE ONLY ON CAD SYSTEM					
						材料 MATERIAL	注記参照 SEE NOTES
						仕上げ FINISH	— // —
						適用電線範囲 WIRE RANGE	— // —
						被覆外径 INS. RANGE	— // —
						DRAWN BY '90/7/11 S.AIHARA	CHK'D BY '93/9/23 T.IITO
						APP'D BY '93/9/23 M.FUKUSHIMA	尺度 SCALE — // —

MOLEX JAPAN CO., LTD. 日本モレックス株式会社	
EDP NO.	REV C
ENG. NO. SD-52418-***10	
TITLE 名称 2.0 BOARD TO BOARD CONN. HOUSING ASS'Y (R/A)	