

**SEMITOP<sup>®</sup>3**

**3-phase bridge rectifier +  
brake chopper + 3-phase  
bridge inverter**  
**SK 30 DGDL 066 ET**

Target Data

### Features

- Compact design
- One screw mounting
- Heat transfer and isolation through direct copper bonded aluminium oxide ceramic (DCB)
- Trench IGBT technology
- CAL technology FWD
- Integrated NTC temperature sensor

### Typical Applications\*

- Inverter up to 10 kVA
- Typ. motor power 4 kW

### Remarks

- $V_{CE,sat}$ ,  $V_F$  = chip level value
- SC data:  
 $t_p \leq 6\mu s$ ;  $V_{GE} \leq 15V$ ;  $T_j = 150^\circ C$ ;  $V_{CC} = 360V$
- $V_{isol} = 3000V$  AC, 50Hz, 1s

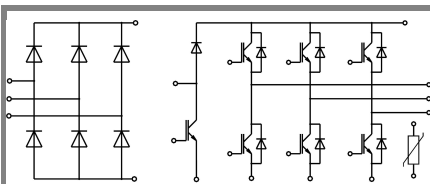

DGDL - ET

Absolute Maximum Ratings		$T_s = 25^\circ C$ , unless otherwise specified	
Symbol	Conditions	Values	Units
<b>IGBT - Inverter, chopper</b>			
$V_{CES}$		600	V
$I_C$	$T_s = 25 (70)^\circ C, T_j = 175^\circ C$	40 (31)	A
$I_C$	$T_s = 25 (70)^\circ C, T_j = 150^\circ C$	35 (26)	A
$I_{CRM}$	$I_{CRM} = 2 \times I_{Cnom}, t_p = 1 ms$	60	A
$V_{GES}$		$\pm 20$	V
$T_j$		-40 ... + 175	$^\circ C$
<b>Diode - Inverter, chopper</b>			
$I_F$	$T_s = 25 (70)^\circ C, T_j = 150^\circ C$	32 (24)	A
$I_F$	$T_s = 25 (70)^\circ C, T_j = 175^\circ C$	36 (28)	A
$I_{FRM}$	$I_{FRM} = 2 \times I_{Fnom}, t_p = 1 ms$	60	A
<b>Diode - Rectifier</b>			
$V_{RRM}$		800	V
$I_F$	$T_s = 70^\circ C$	35	A
$I_{FSM}$	$t_p = 10 ms, \sin 180^\circ, T_j = 25^\circ C$	370	A
$i^2t$	$t_p = 10 ms, \sin 180^\circ, T_j = 25^\circ C$	680	$A^2s$
$T_j$		-40 ... + 175	$^\circ C$
$T_{sol}$	Terminals, 10 s	260	$^\circ C$
$T_{stg}$		-40 ... + 125	$^\circ C$
$V_{isol}$	AC, 1 min.	2500	V

Characteristics		$T_s = 25^\circ C$ , unless otherwise specified			
Symbol	Conditions	min.	typ.	max.	Units
<b>IGBT - Inverter, chopper</b>					
$V_{CE(sat)}$	$I_{Cnom} = 30 A, T_j = 25 (150)^\circ C$		1,45 (1,65)	1,85 (2,05)	V
$V_{GE(th)}$	$V_{GE} = V_{CE}, I_C = 0,43 mA$	5	5,8	6,5	V
$V_{CE(TO)}$	$T_j = 25 (150)^\circ C$		0,9 (0,85)	1 (0,9)	V
$r_{CE}$	$T_j = 25 (150)^\circ C$		18 (27)	28 (38)	m $\Omega$
$C_{ies}$	$V_{CE} = 25 V, V_{GE} = 0 V, f = 1 MHz$		1,63		nF
$C_{oes}$	$V_{CE} = 25 V, V_{GE} = 0 V, f = 1 MHz$		0,11		nF
$C_{res}$	$V_{CE} = 25 V, V_{GE} = 0 V, f = 1 MHz$		0,05		nF
$R_{th(j-s)}$	per IGBT		1,65		K/W
$t_{d(on)}$	under following conditions		15		ns
$t_r$	$V_{CC} = 300 V, V_{GE} = -7/+15$		12		ns
$t_{d(off)}$	$I_{Cnom} = 30 A, T_j = 125^\circ C$		228		ns
$t_f$	$R_{Gon} = R_{Goff} = 12 \Omega$		46		ns
$E_{on} (E_{off})$	inductive load		0,55 (1,15)		mJ
<b>Diode - Inverter, chopper</b>					
$V_F = V_{EC}$	$I_F = 30 A, T_j = 25 (150)^\circ C$		1,5 (1,5)	1,7 (1,7)	V
$V_{(TO)}$	$T_j = 25 (150)^\circ C$		1 (0,9)		V
$r_T$	$T_j = 150 ( )^\circ C$		20		m $\Omega$
$R_{th(j-s)}$	per diode		2,3		K/W
$I_{RRM}$	under following conditions		19,1		A
$Q_{rr}$	$I_{Fnom} = 30 A, V_R = 300 V$		1,8		$\mu C$
$E_{rr}$	$V_{GE} = 0 V, T_j = 125^\circ C$		0,53		mJ
	$di_F/dt = -950 A/\mu s$				
<b>Diode rectifier</b>					
$V_F$	$I_{Fnom} = 25 A, T_j = 25^\circ C$		1,1		V
$V_{(TO)}$	$T_j = 150^\circ C$		0,8		V
$r_T$	$T_j = 150^\circ C$		15		m $\Omega$
$R_{th(j-s)}$	per diode		1,7		K/W
<b>Temperature Sensor</b>					
$R_{ts}$	5 %, $T_r = 25 (100)^\circ C$		5000(493)		$\Omega$
<b>Mechanical Data</b>					
w			30		g
$M_s$	Mounting torque	2,25		2,5	Nm

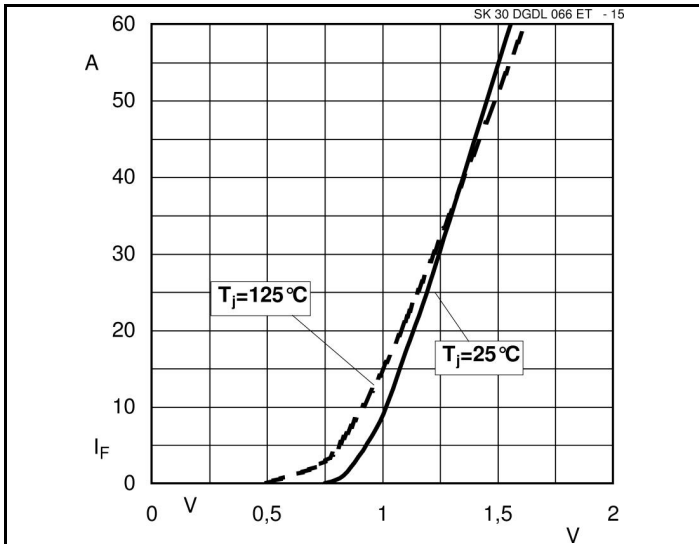

Fig. 15 Input Bridge Diode forward characteristic

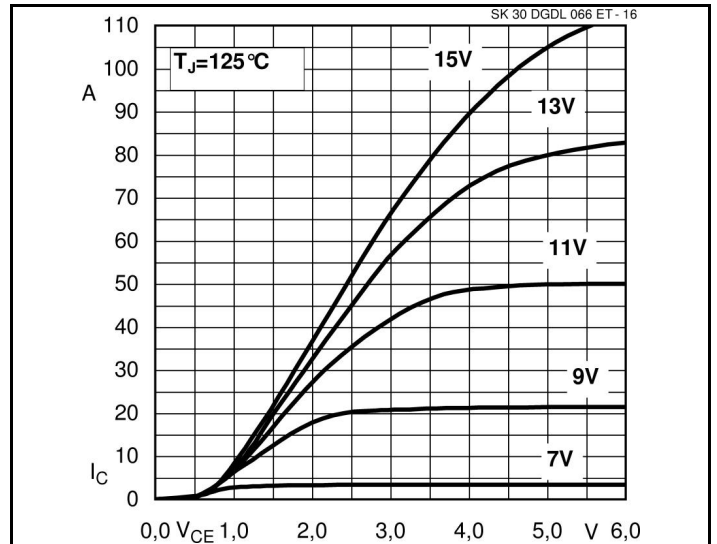

Fig. 16 Typical Output Characteristic

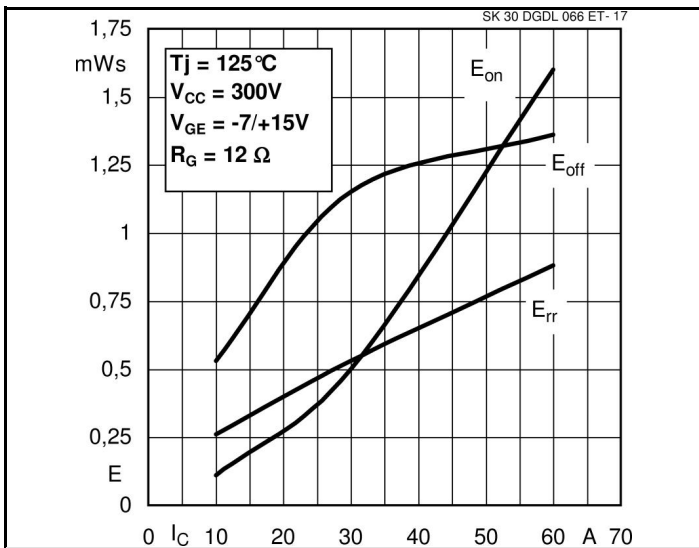

Fig. 17 Turn-on/off energy=f(I<sub>C</sub>)

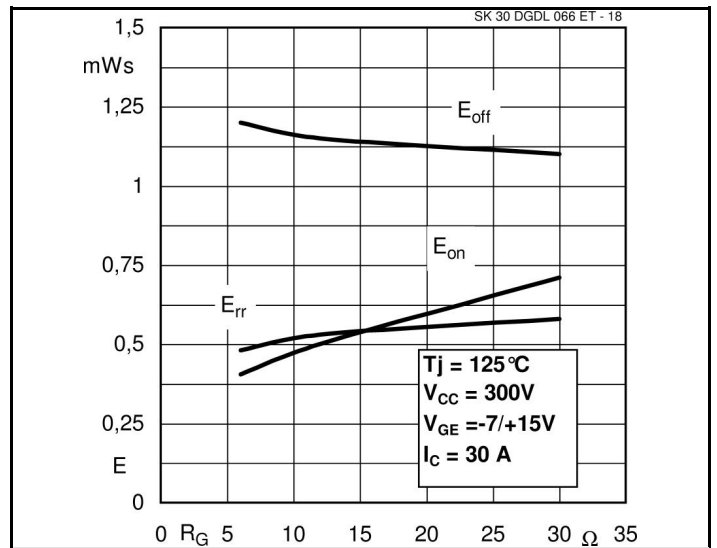

Fig. 18 Turn-on/off energy=f(R<sub>G</sub>)

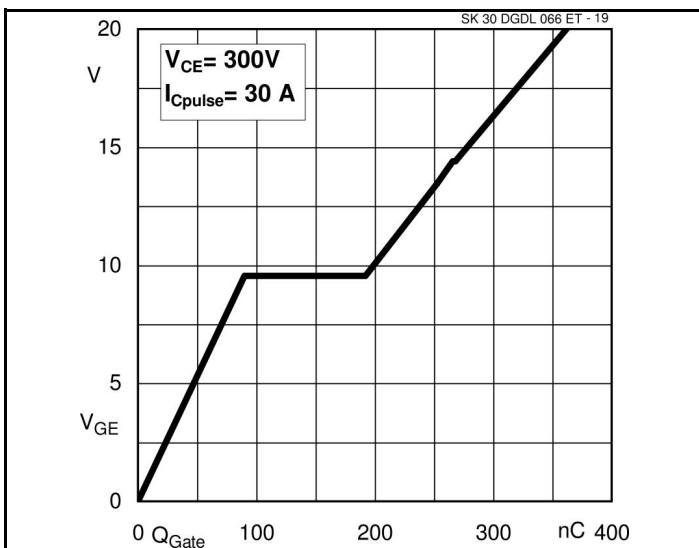
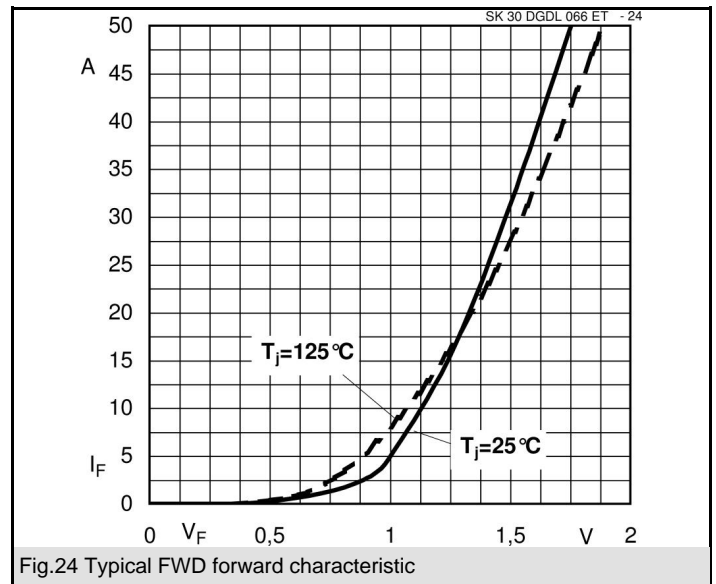
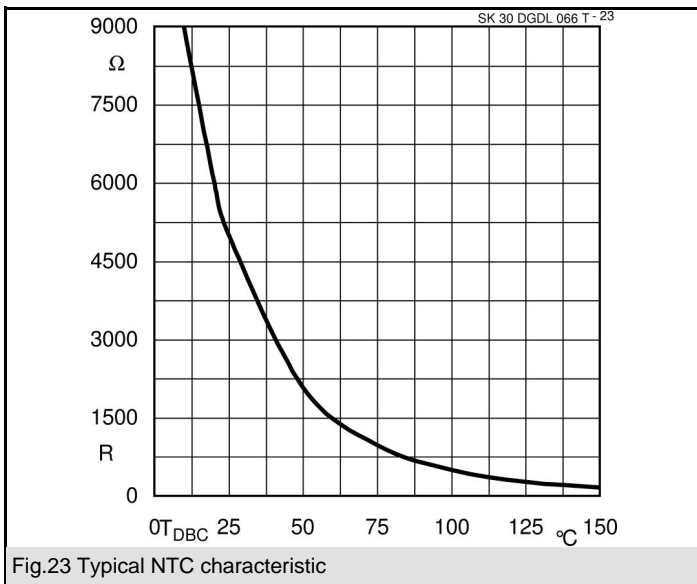
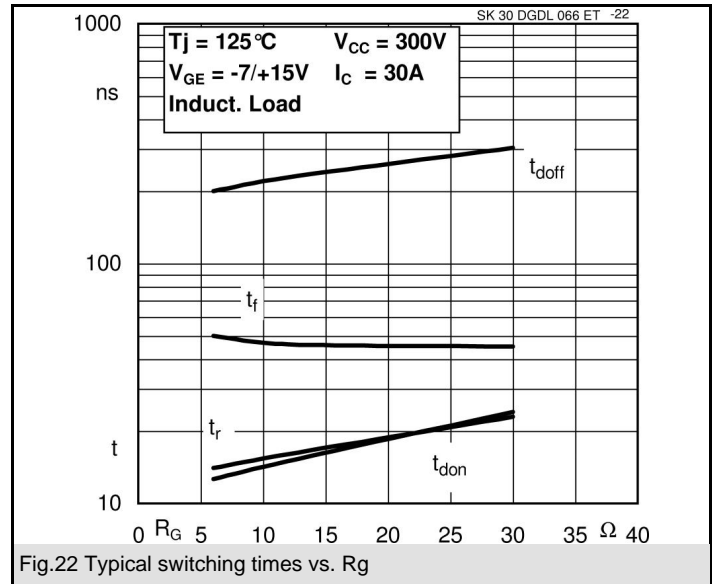
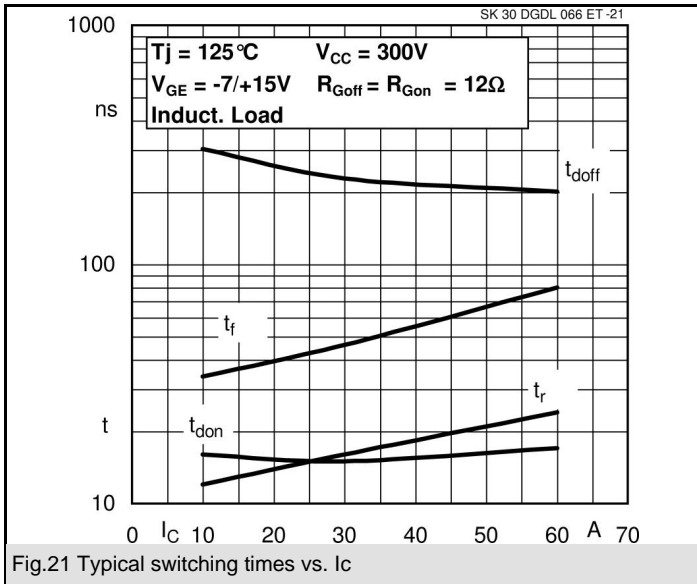
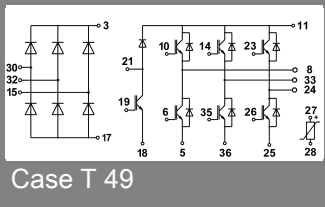

Fig. 19 Typical gate charge characteristic



# SK 30 DGDL 066 ET



UL recognized  
file no. E 63 532

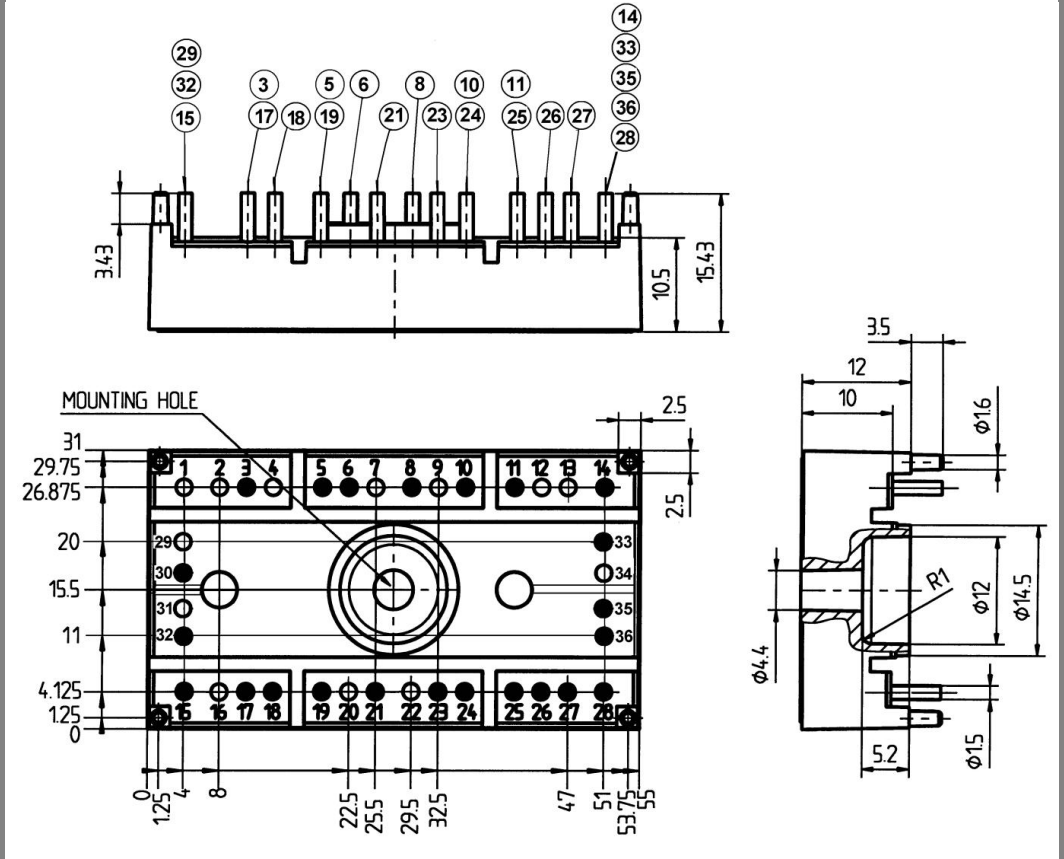

Case T 49 (Suggested hole diameter, in the PCB, for solder pins and plastic mounting pins: 2mm)

This is an electrostatic discharge sensitive device (ESDS), international standard IEC 60747-1, Chapter IX.

\* The specifications of our components may not be considered as an assurance of component characteristics. Components have to be tested for the respective application. Adjustments may be necessary. The use of SEMIKRON products in life support appliances and systems is subject to prior specification and written approval by SEMIKRON. We therefore strongly recommend prior consultation of our personal.