

FEATURES

- **NEW MINIATURE M13 PACKAGE:**
 - Small transistor outline
 - 1.0 X 0.5 X 0.5 mm
 - Low profile / 0.50 mm package height
 - Flat lead style for better RF performance
- **HIGH GAIN BANDWIDTH PRODUCT:**
 $f_T = 12 \text{ GHz}$
- **LOW NOISE FIGURE:**
 $NF = 1.5 \text{ dB at } 2 \text{ GHz}$

DESCRIPTION

NEC's NE685M13 transistor is designed for low noise, high gain, and low cost requirements. This high f_T part is well suited for low voltage/low current designs for portable wireless communications and cellular radio applications. NEC's new low profile/flat lead style "M13" package is ideal for today's portable wireless applications. The NE685 is also available in six different low cost plastic surface mount package styles.

OUTLINE DIMENSIONS (Units in mm)

PACKAGE OUTLINE M13

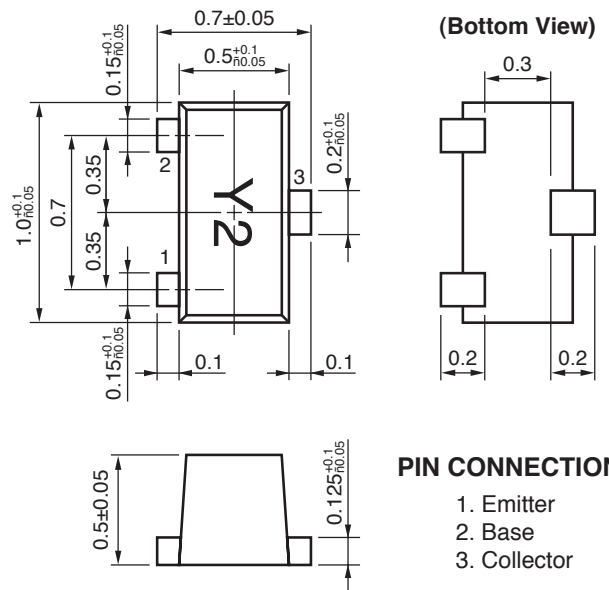

PIN CONNECTIONS

1. Emitter
2. Base
3. Collector

ELECTRICAL CHARACTERISTICS ($T_A = 25^\circ\text{C}$)

PART NUMBER EIAJ ¹ REGISTERED NUMBER PACKAGE OUTLINE		NE685M13 2SC5617 M13			
SYMBOLS	PARAMETERS AND CONDITIONS	UNITS	MIN	TYP	MAX
f_T	Gain Bandwidth at $V_{CE} = 3 \text{ V}$, $I_C = 10 \text{ mA}$, $f = 2 \text{ GHz}$	GHz		12.0	
NF	Noise Figure at $V_{CE} = 3 \text{ V}$, $I_C = 3 \text{ mA}$, $f = 2 \text{ GHz}$, $Z_S = Z_{OPT}$	dB		1.5	2.5
$ S_{21E} ^2$	Insertion Power Gain at $V_{CE} = 3 \text{ V}$, $I_C = 10 \text{ mA}$, $f = 2 \text{ GHz}$	dB	7.0	11.0	
h_{FE}^2	Forward Current Gain at $V_{CE} = 3 \text{ V}$, $I_C = 10 \text{ mA}$		75		140
I_{CBO}	Collector Cutoff Current at $V_{CB} = 5 \text{ V}$, $I_E = 0$	μA			0.1
I_{EBO}	Emitter Cutoff Current at $V_{EB} = 1 \text{ V}$, $I_C = 0$	μA			0.1
C_{RE}^3	Feedback Capacitance at $V_{CB} = 3 \text{ V}$, $I_E = 0$, $f = 1 \text{ MHz}$	pF		0.4	0.7

Notes:

1. Electronic Industrial Association of Japan.
2. Pulsed measurement, pulse width $\leq 350 \mu\text{s}$, duty cycle $\leq 2\%$.
3. Capacitance is measured with emitter and case connected to the guard terminal at the bridge.

NE685M13

ABSOLUTE MAXIMUM RATINGS¹ (T_A = 25°C)

SYMBOLS	PARAMETERS	UNITS	RATINGS
V _{CB0}	Collector to Base Voltage	V	9.0
V _{CE0}	Collector to Emitter Voltage	V	6.0
V _{EB0}	Emitter to Base Voltage	V	2.0
I _C	Collector Current	mA	30
P _T ²	Total Power Dissipation	mW	140
T _J	Junction Temperature	°C	150
T _{STG}	Storage Temperature	°C	-65 to +150

Notes:

1. Operation in excess of any one of these parameters may result in permanent damage.
2. With device mounted on 1.08 cm² X 1.2 mm thick glass epoxy PCB.

ORDERING INFORMATION

PART NUMBER	QUANTITY
NE685M13-T3-A	3k pcs./reel

TYPICAL PERFORMANCE CURVES (T_A = 25°C)

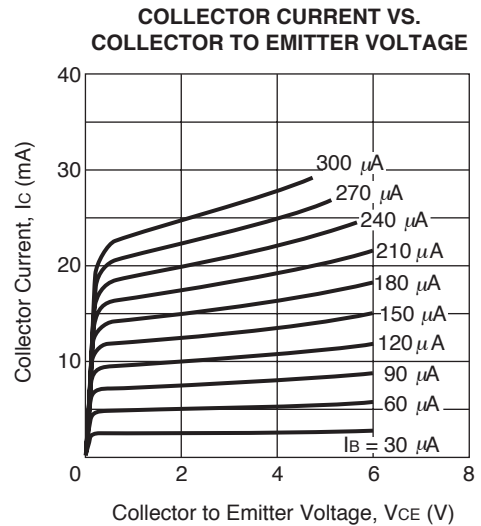
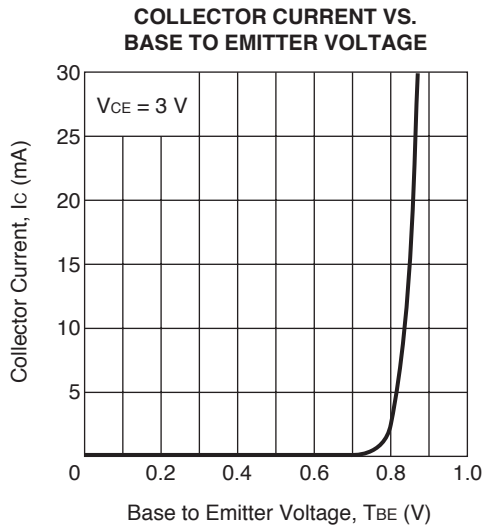
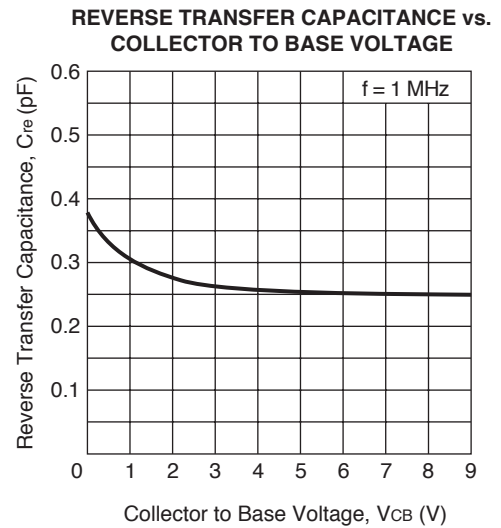
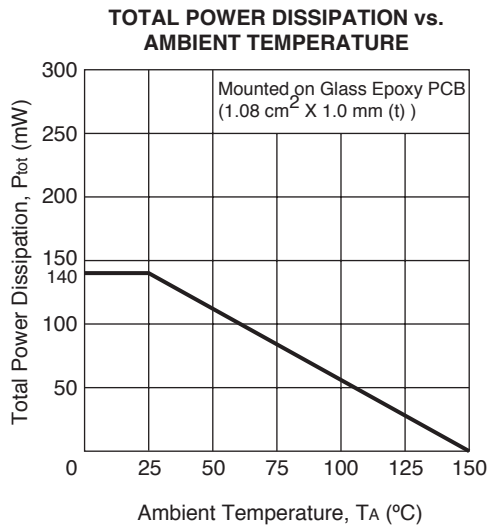

TYPICAL PERFORMANCE CURVES ($T_A = 25^\circ\text{C}$)

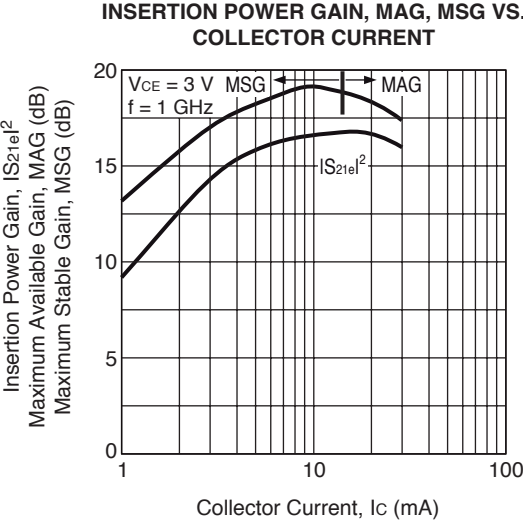
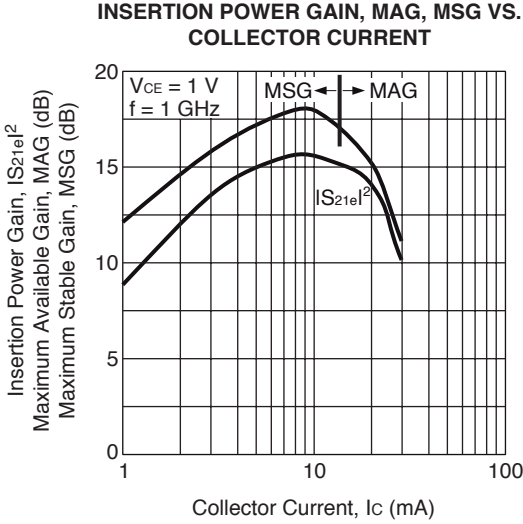
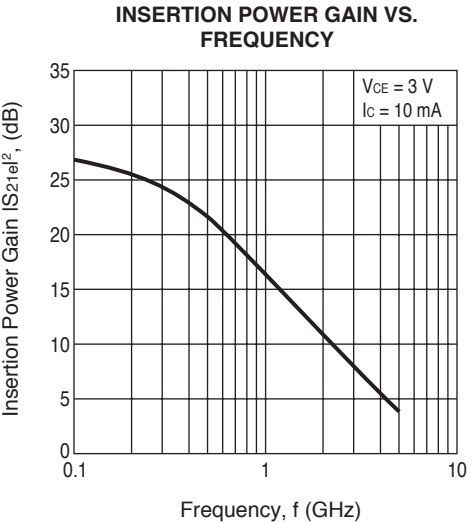
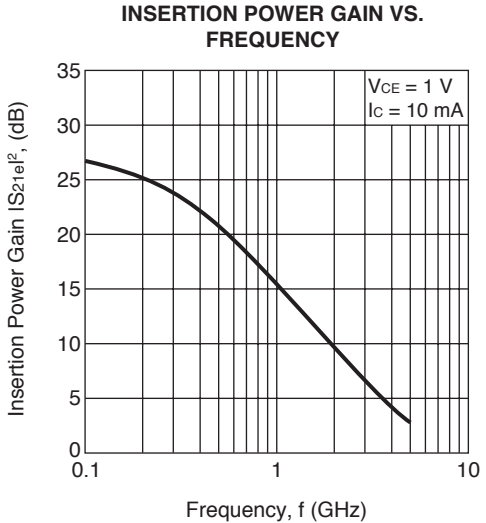
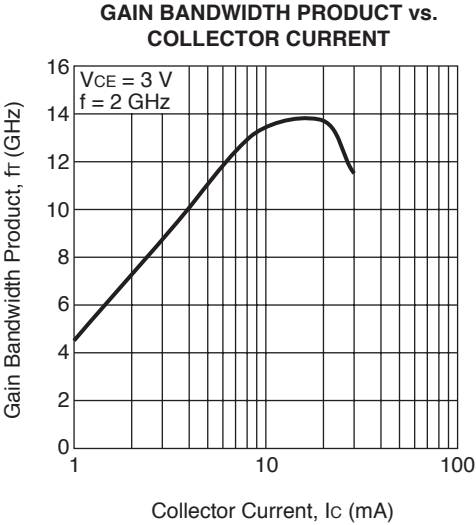
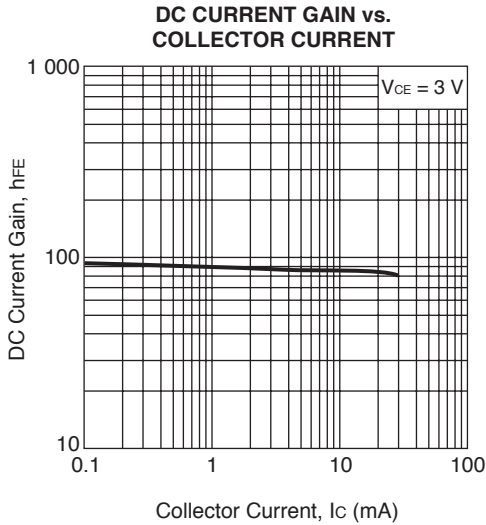

TYPICAL PERFORMANCE CURVES (TA = 25°C)

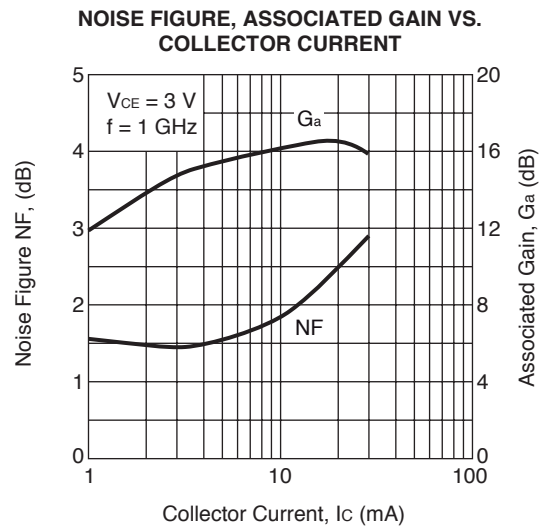
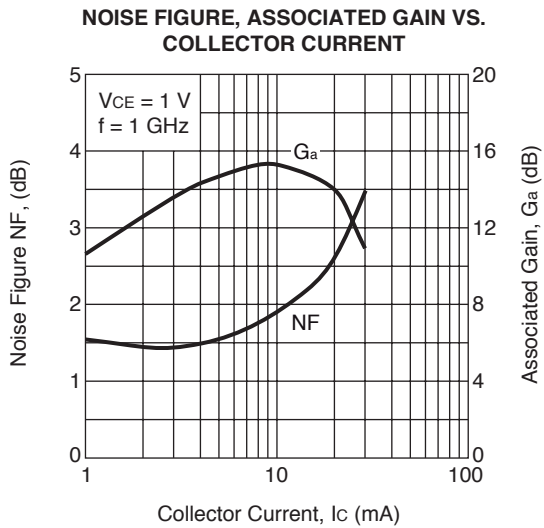
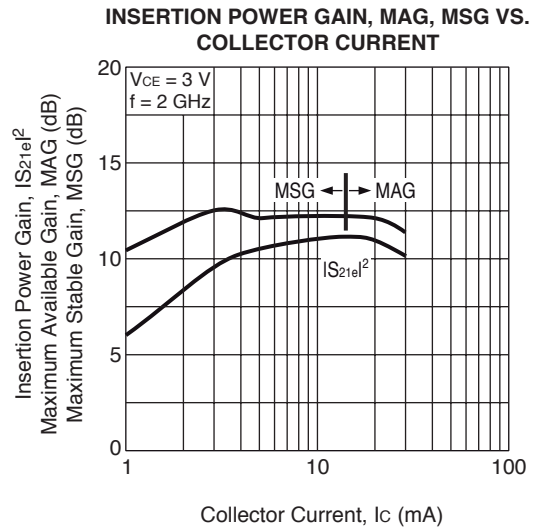
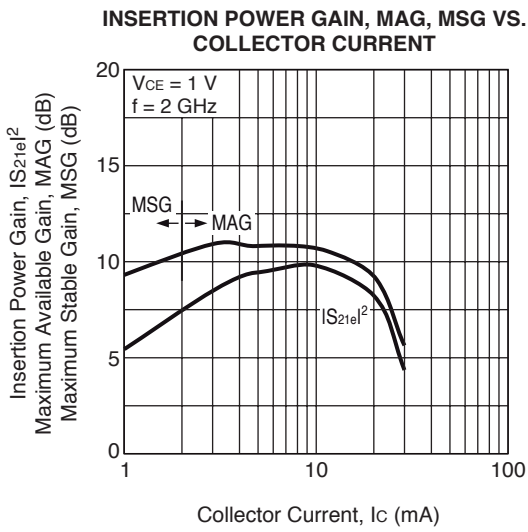

TYPICAL PERFORMANCE CURVES (TA = 25°C)

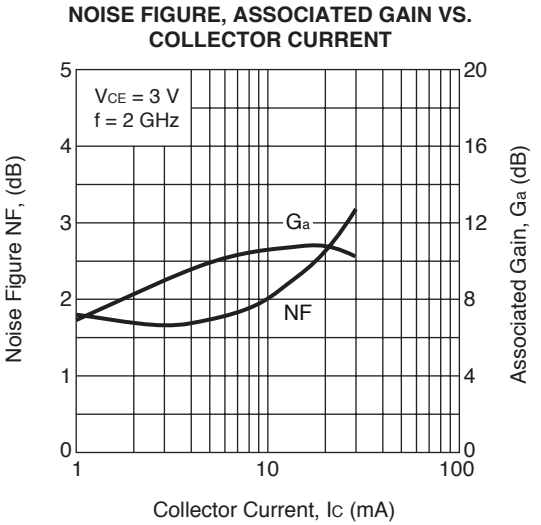
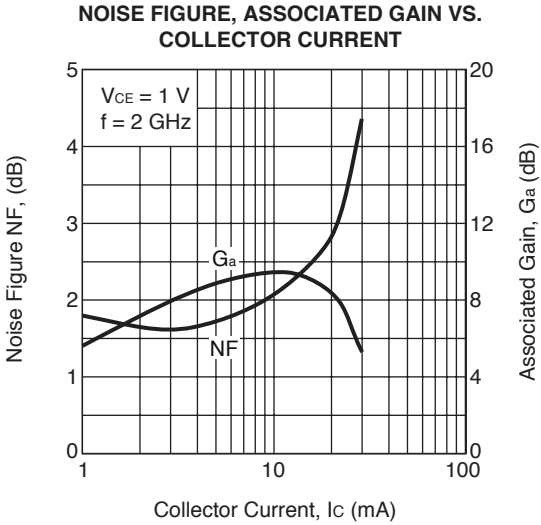

NE685M13

TYPICAL SCATTERING PARAMETERS (T_A = 25°C)

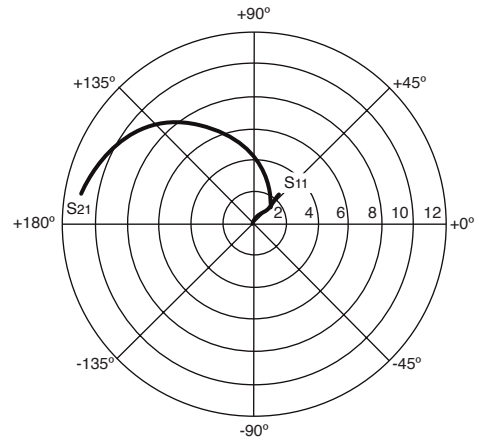
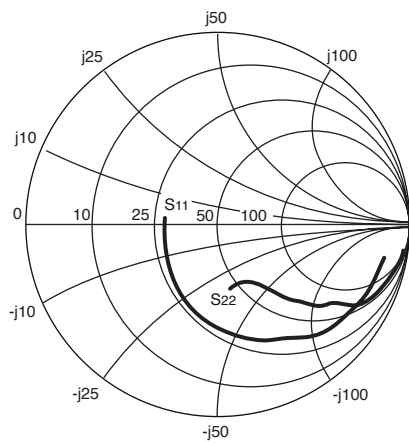

NE685M13

V_c = 2 V, I_c = 5 mA

FREQUENCY GHz	S ₁₁		S ₂₁		S ₁₂		S ₂₂		K	MAG ¹ (dB)
	MAG	ANG	MAG	ANG	MAG	ANG	MAG	ANG		
0.100	0.879	-11.18	10.895	169.79	0.017	85.46	0.980	-8.26	0.05	27.96
0.200	0.854	-24.79	10.531	159.27	0.033	76.47	0.943	-15.79	0.13	25.05
0.300	0.813	-36.17	9.980	150.16	0.047	70.32	0.894	-22.51	0.19	23.25
0.400	0.764	-46.95	9.356	142.00	0.059	65.55	0.843	-28.26	0.24	21.98
0.500	0.677	-58.07	8.645	133.16	0.069	59.99	0.756	-32.30	0.37	21.00
0.600	0.634	-67.22	7.952	127.18	0.077	57.31	0.701	-35.05	0.43	20.16
0.700	0.597	-75.01	7.355	122.04	0.083	55.43	0.657	-38.07	0.47	19.46
0.800	0.560	-82.74	6.818	117.17	0.089	53.53	0.615	-40.74	0.51	18.82
0.900	0.530	-89.38	6.315	113.03	0.095	52.58	0.579	-42.38	0.56	18.24
1.000	0.501	-95.62	5.872	109.14	0.099	51.55	0.542	-44.09	0.61	17.73
1.100	0.478	-101.10	5.483	105.72	0.104	50.81	0.515	-45.60	0.65	17.22
1.200	0.459	-106.13	5.137	102.65	0.108	50.49	0.491	-47.11	0.68	16.79
1.400	0.425	-114.91	4.543	97.14	0.116	50.07	0.451	-49.16	0.76	15.94
1.600	0.399	-122.59	4.068	92.39	0.123	50.09	0.417	-50.64	0.82	15.18
1.800	0.379	-129.37	3.678	88.20	0.131	50.25	0.394	-52.06	0.88	14.49
2.000	0.364	-135.19	3.369	84.36	0.138	50.70	0.377	-53.48	0.92	13.87
2.200	0.350	-140.57	3.103	80.91	0.146	51.06	0.362	-55.00	0.96	13.27
2.400	0.339	-145.78	2.882	77.59	0.154	51.17	0.351	-56.70	0.99	12.73
2.600	0.330	-150.79	2.695	74.45	0.162	51.40	0.343	-58.44	1.02	11.43
2.800	0.321	-155.59	2.529	71.46	0.170	51.61	0.335	-60.35	1.04	10.49
3.000	0.312	-160.44	2.386	68.56	0.178	51.67	0.328	-62.49	1.06	9.75
3.200	0.306	-165.34	2.263	65.81	0.186	51.55	0.324	-65.12	1.08	9.16
3.400	0.301	-170.19	2.150	63.12	0.194	51.53	0.323	-67.74	1.09	8.63
3.600	0.296	-175.11	2.048	60.52	0.202	51.43	0.323	-70.53	1.10	8.14
3.800	0.291	-179.68	1.957	58.06	0.210	51.16	0.327	-73.25	1.10	7.72
4.000	0.286	-176.05	1.874	55.66	0.218	51.06	0.332	-75.87	1.11	7.33

Note:

1. Gain Calculations:

$$MAG = \frac{|S_{21}|}{|S_{12}|} (K \pm \sqrt{K^2 - 1}). \text{ When } K \leq 1, \text{ MAG is undefined and MSG values are used. } MSG = \frac{|S_{21}|}{|S_{12}|}, K = \frac{1 + |\Delta|^2 - |S_{11}|^2 - |S_{22}|^2}{2 |S_{12}| |S_{21}|}, \Delta = S_{11} S_{22} - S_{21} S_{12}$$

MAG = Maximum Available Gain

MSG = Maximum Stable Gain

TYPICAL SCATTERING PARAMETERS (TA = 25°C)

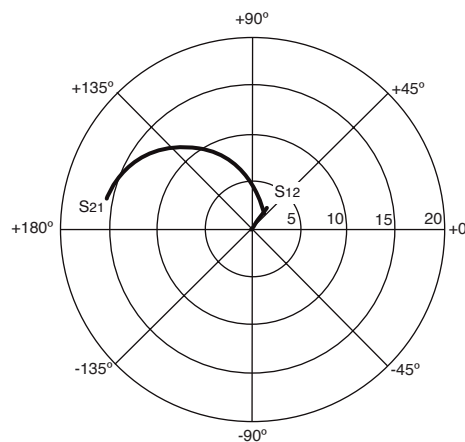
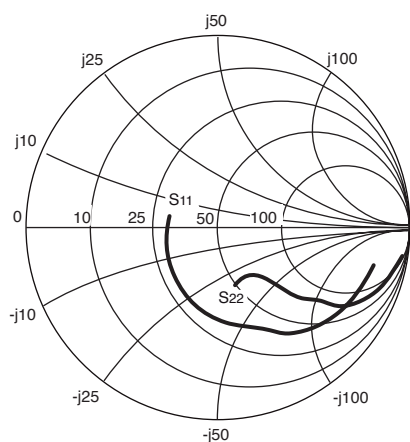

NE685M13

Vc = 3 V, Ic = 10 mA

FREQUENCY GHz	S11		S21		S12		S22		K	MAG ¹ (dB)
	MAG	ANG	MAG	ANG	MAG	ANG	MAG	ANG		
0.100	0.830	-14.89	15.406	167.04	0.015	79.15	0.969	-9.82	0.15	30.06
0.200	0.791	-30.25	14.529	155.17	0.029	74.31	0.918	-18.40	0.18	26.96
0.300	0.734	-43.35	13.385	144.88	0.041	68.95	0.852	-25.66	0.25	25.11
0.400	0.675	-55.24	12.178	136.08	0.050	64.19	0.786	-31.42	0.32	23.86
0.500	0.584	-67.02	10.911	127.43	0.058	59.86	0.690	-34.94	0.46	22.75
0.600	0.541	-76.48	9.839	121.58	0.064	57.87	0.631	-37.08	0.52	21.86
0.700	0.506	-84.40	8.943	116.65	0.069	56.90	0.586	-39.46	0.57	21.10
0.800	0.473	-92.17	8.163	112.19	0.075	55.96	0.546	-41.46	0.62	20.39
0.900	0.448	-98.62	7.477	108.45	0.079	55.53	0.513	-42.47	0.66	19.74
1.000	0.423	-104.84	6.891	104.94	0.083	55.34	0.478	-43.52	0.71	19.17
1.100	0.405	-110.11	6.385	101.90	0.088	55.24	0.455	-44.52	0.75	18.61
1.200	0.390	-114.95	5.947	99.15	0.092	55.23	0.435	-45.57	0.78	18.09
1.400	0.364	-123.47	5.216	94.22	0.100	55.77	0.401	-46.75	0.85	17.16
1.600	0.344	-130.71	4.640	90.04	0.109	56.13	0.373	-47.51	0.90	16.29
1.800	0.329	-137.11	4.179	86.28	0.117	56.73	0.355	-48.39	0.94	15.52
2.000	0.318	-142.56	3.809	82.88	0.126	57.15	0.341	-49.39	0.97	14.81
2.200	0.308	-147.52	3.499	79.73	0.135	57.35	0.330	-50.56	1.00	14.15
2.400	0.300	-152.37	3.242	76.73	0.144	57.60	0.322	-51.97	1.02	12.70
2.600	0.294	-157.24	3.024	73.87	0.153	57.62	0.316	-53.62	1.03	11.86
2.800	0.287	-161.72	2.834	71.13	0.162	57.53	0.310	-55.48	1.05	11.10
3.000	0.282	-166.38	2.670	68.47	0.171	57.39	0.304	-57.60	1.06	10.45
3.200	0.277	-170.99	2.526	65.91	0.180	57.27	0.302	-60.04	1.07	9.89
3.400	0.273	-175.85	2.397	63.40	0.189	56.83	0.301	-62.78	1.07	9.38
3.600	0.270	179.25	2.282	60.99	0.197	56.62	0.302	-65.63	1.08	8.91
3.800	0.266	174.83	2.179	58.67	0.207	56.19	0.306	-68.43	1.08	8.51
4.000	0.263	170.53	2.084	56.42	0.215	55.67	0.311	-71.13	1.08	8.11

Note:

1. Gain Calculations:

$$MAG = \frac{|S_{21}|}{|S_{12}|} (K \pm \sqrt{K^2 - 1})$$

When K ≤ 1, MAG is undefined and MSG values are used. $MSG = \frac{|S_{21}|}{|S_{12}|}$, $K = \frac{1 + |\Delta|^2 - |S_{11}|^2 - |S_{22}|^2}{2 |S_{12}| |S_{21}|}$, $\Delta = S_{11} S_{22} - S_{21} S_{12}$

MAG = Maximum Available Gain

MSG = Maximum Stable Gain

NE685M13

NE685M13 NONLINEAR MODEL

BJT NONLINEAR MODEL PARAMETERS (1)

Parameters	Q1	Parameters	Q1
IS	7e-16	MJC	0.34
BF	109	XCJC	0.7
NF	1	CJS	0
VAF	15	VJS	0.75
IKF	0.19	MJS	0
ISE	7.9e-13	FC	0.5
NE	2.19	TF	2.5e-12
BR	1	XTF	5.2
NR	1.08	VTF	4.58
VAR	12.4	ITF	0.011
IKR	0	PTF	0
ISC	0	TR	1e-9
NC	2	EG	1.11
RE	1.3	XTB	0
RB	10	XTI	3
RBM	8.34	KF	0
IRB	0.009	AF	1
RC	10		
CJE	0.4e-12		
VJE	0.812		
MJE	0.5		
CJC	0.18e-12		
VJC	0.75		

(1) Gummel-Poon Model

UNITS

Parameter	Units
time	seconds (S)
capacitance	farads (F)
inductance	henries (H)
resistance	ohms (Ω)
voltage	volts (V)
current	amps (A)

SCHEMATIC

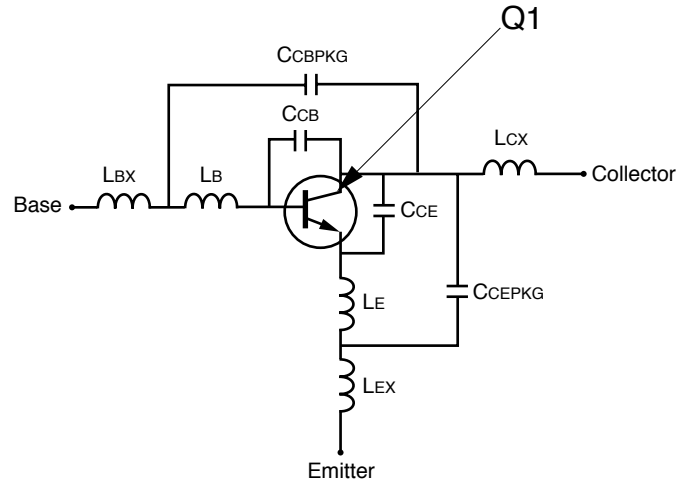

ADDITIONAL PARAMETERS

Parameters	68533
C _{CB}	0.1e-12
C _{CCE}	0.14e-12
L _B	0.35e-9
L _E	0.4e-9
C _{CBPKG}	0.05e-12
C _{CCEPKG}	0.05e-12
L _{BX}	0.05e-9
L _{CX}	0.05e-9
L _{EX}	0.05e-9

MODEL RANGE

Frequency: 0.1 to 4.0 GHz
 Bias: $V_{CE} = 0.5$ V to 3 V, $I_C = 0.5$ mA to 20 mA
 Date: 09/02

Life Support Applications

These NEC products are not intended for use in life support devices, appliances, or systems where the malfunction of these products can reasonably be expected to result in personal injury. The customers of CEL using or selling these products for use in such applications do so at their own risk and agree to fully indemnify CEL for all damages resulting from such improper use or sale.

Subject: Compliance with EU Directives

CEL certifies, to its knowledge, that semiconductor and laser products detailed below are compliant with the requirements of European Union (EU) Directive 2002/95/EC Restriction on Use of Hazardous Substances in electrical and electronic equipment (RoHS) and the requirements of EU Directive 2003/11/EC Restriction on Penta and Octa BDE.

CEL Pb-free products have the same base part number with a suffix added. The suffix –A indicates that the device is Pb-free. The –AZ suffix is used to designate devices containing Pb which are exempted from the requirement of RoHS directive (*). In all cases the devices have Pb-free terminals. All devices with these suffixes meet the requirements of the RoHS directive.

This status is based on CEL’s understanding of the EU Directives and knowledge of the materials that go into its products as of the date of disclosure of this information.

Restricted Substance per RoHS	Concentration Limit per RoHS (values are not yet fixed)	Concentration contained in CEL devices	
		-A	-AZ
Lead (Pb)	< 1000 PPM	Not Detected	(*)
Mercury	< 1000 PPM	Not Detected	
Cadmium	< 100 PPM	Not Detected	
Hexavalent Chromium	< 1000 PPM	Not Detected	
PBB	< 1000 PPM	Not Detected	
PBDE	< 1000 PPM	Not Detected	

If you should have any additional questions regarding our devices and compliance to environmental standards, please do not hesitate to contact your local representative.

Important Information and Disclaimer: Information provided by CEL on its website or in other communications concerning the substance content of its products represents knowledge and belief as of the date that it is provided. CEL bases its knowledge and belief on information provided by third parties and makes no representation or warranty as to the accuracy of such information. Efforts are underway to better integrate information from third parties. CEL has taken and continues to take reasonable steps to provide representative and accurate information but may not have conducted destructive testing or chemical analysis on incoming materials and chemicals. CEL and CEL suppliers consider certain information to be proprietary, and thus CAS numbers and other limited information may not be available for release.

In no event shall CEL’s liability arising out of such information exceed the total purchase price of the CEL part(s) at issue sold by CEL to customer on an annual basis.

See CEL Terms and Conditions for additional clarification of warranties and liability.