



## A5970D

### 1.5A switch step down switching regulator for automotive applications

#### Features

- Qualified following the AEC-Q100 requirements (temperature Grade 3), see PPAP for more details.
- Temperature range -40 °C to 85 °C
- Up to 1 A DC output current
- Operating input voltage from 4.4 V to 36 V
- Output voltage adjustable from 1.235 V to 35 V
- Low dropout operation: 100 % duty cycle
- 250 kHz Internally fixed frequency
- Voltage feedforward
- Zero load current operation
- Internal current limiting
- Inhibit for zero current consumption
- Synchronization
- Protection against feedback disconnection
- Thermal shutdown

#### Applications

- Dedicated to automotive applications

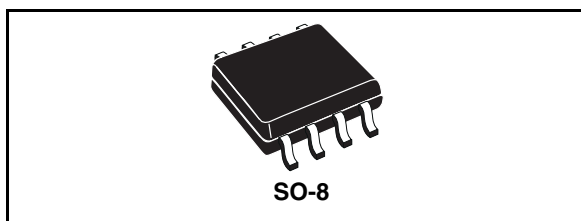

#### Description

The A5970D is a step down monolithic power switching regulator capable to deliver up to 1 A at output voltages from 1.2 V to 35 V.

The device uses an internal P-channel D-MOS transistor (with a typical  $R_{ds(on)}$  of 250 m $\Omega$ ) as switching element to minimize the size of the external components.

An internal oscillator fixes the switching frequency at 250 kHz.

Having a minimum input voltage of 4.4 V only, it is particularly suitable for 5 V bus.

Pulse by pulse current limit with the internal frequency modulation offers an effective constant current short circuit protection.

Figure 1. Typical application

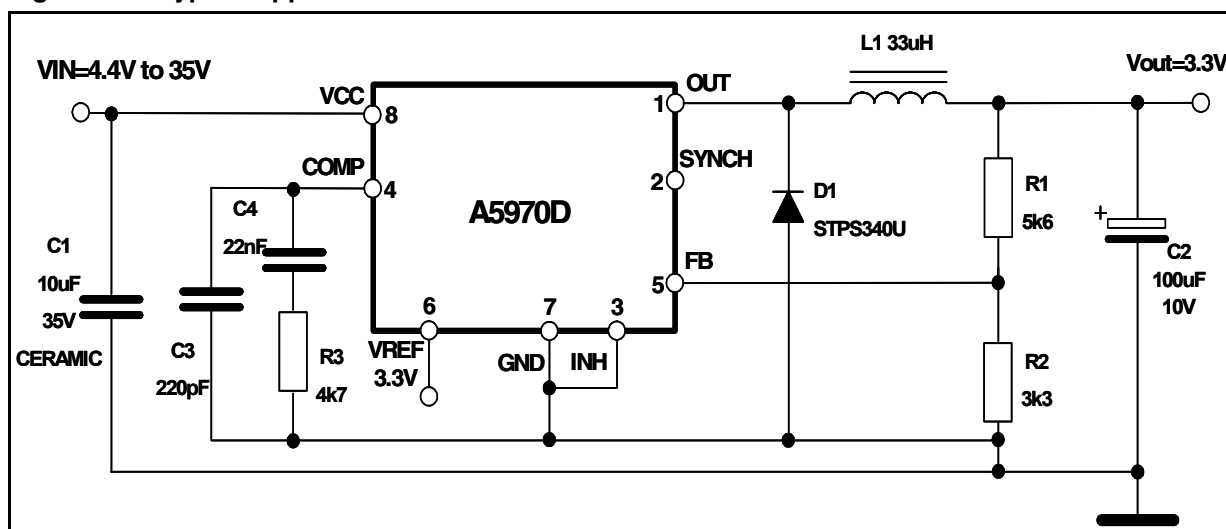

# Contents

<b>1</b>	<b>Pin settings</b> .....	<b>3</b>
1.1	Pin connection .....	3
1.2	Pin description .....	3
<b>2</b>	<b>Electrical data</b> .....	<b>4</b>
2.1	Maximum ratings .....	4
2.2	Thermal data .....	4
<b>3</b>	<b>Electrical characteristics</b> .....	<b>5</b>
<b>4</b>	<b>Typical characteristics</b> .....	<b>7</b>
<b>5</b>	<b>Package mechanical data</b> .....	<b>9</b>
<b>6</b>	<b>Order codes</b> .....	<b>11</b>
<b>7</b>	<b>Revision history</b> .....	<b>12</b>

## A5970D

# 1 Pin settings

## 1.1 Pin connection

Figure 2. Pin connection (top view)

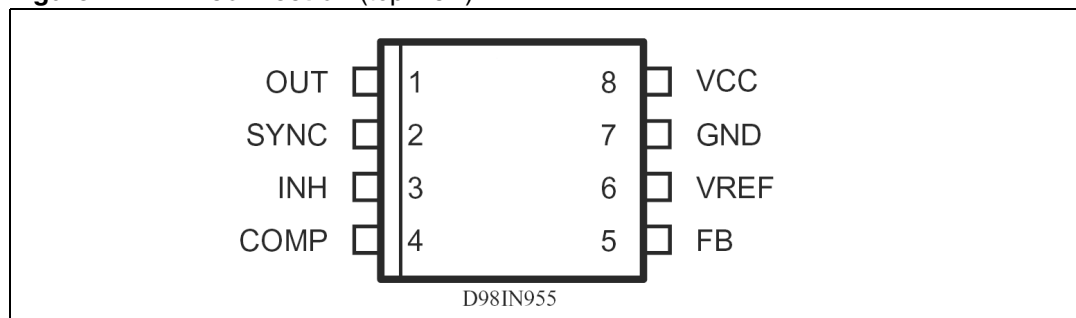

## 1.2 Pin description

Table 1. Pin description

N	Pin	Description
1	OUT	Regulator output.
2	SYNCH	Master/slave synchronization.
3	INH	A logical signal (active high) disables the device. If INH not used the pin must be grounded. When it is open an internal pull-up disable the device.
4	COMP	E/A output for frequency compensation.
5	FB	Feedback input. Connecting directly to this pin results in an output voltage of 1.23V. An external resistive divider is required for higher output voltages.
6	VREF	3.3V VREF. No cap is requested for stability.
7	GND	Ground.
8	VCC	Unregulated DC input voltage.

## 2 Electrical data

### 2.1 Maximum ratings

**Table 2. Absolute maximum ratings**

Symbol	Parameter	Value	Unit
$V_8$	Input voltage	40	V
$V_1$	OUT pin DC voltage	-1 to 40	V
	OUT pin peak voltage at $\Delta t=0.1\mu s$	-5 to 40	V
$I_1$	Maximum output current	int. limit.	
$V_4, V_5$	Analog pins	4	V
$V_3$	INH	-0.3 to $V_{CC}$	V
$V_2$	SYNCH	-0.3 to 4	V
$P_{TOT}$	Power dissipation at $T_A \leq 70^\circ C$	0.75	W
$T_J$	Operating junction temperature range	-40 to 150	$^\circ C$
$T_{STG}$	Storage temperature range	-55 to 150	$^\circ C$

### 2.2 Thermal data

**Table 3. Thermal data**

Symbol	Parameter	SO8	Unit
$R_{thJA}$	Maximum thermal resistance junction-ambient	120 <sup>(1)</sup>	$^\circ C/W$

1. Package mounted on board

### 3 Electrical characteristics

**Table 4. Electrical characteristics** ( $T_J = -40$  to  $85^\circ\text{C}$ ,  $V_{CC} = 12\text{V}$ , unless otherwise specified)

Symbol	Parameter	Test condition	Min	Typ	Max	Unit
$V_{CC}$	Operating input voltage range	$V_0 = 1.235\text{V}$ ; $I_0 = 1\text{A}$	4.4		36	V
$R_{DS(on)}$	Mosfet on resistance			0.250	0.5	$\Omega$
$I_L$	Maximum limiting current	$V_{CC} = 5\text{V}$ ;	1.5	1.87	2.25	A
$f_{SW}$	Switching frequency		212	250	280	kHz
	Duty cycle		0		100	%
<b>Dynamic characteristics</b> (see test circuit).						
$V_5$	Voltage feedback	$4.4\text{V} < V_{CC} < 36\text{V}$ , $20\text{mA} < I_0 < 2\text{A}$	1.198	1.235	1.272	V
$\eta$	Efficiency	$V_0 = 5\text{V}$ , $V_{CC} = 12\text{V}$		90		%
<b>DC characteristics</b>						
$I_{qop}$	Total operating quiescent current			3	5	mA
$I_q$	Quiescent current	Duty cycle=0; $V_{FB} = 1.5\text{V}$			2.5	mA
$I_{qst-by}$	Total stand-by quiescent current	$V_{inh} > 2.2\text{V}$		50	100	$\mu\text{A}$
		$V_{CC} = 36\text{V}$ ; $V_{inh} > 2.2\text{V}$		80	150	$\mu\text{A}$
<b>Inhibit</b>						
	INH threshold voltage	Device ON			0.8	V
		Device OFF	2.2			V
<b>Error amplifier</b>						
$V_{OH}$	High level output voltage	$V_{FB} = 1\text{V}$	3.5			V
$V_{OL}$	Low level output voltage	$V_{FB} = 1.5\text{V}$			0.4	V
$I_{o\ source}$	Source output current	$V_{COMP} = 1.9\text{V}$ ; $V_{FB} = 1\text{V}$	190	300		$\mu\text{A}$
$I_{o\ sink}$	Sink output current	$V_{COMP} = 1.9\text{V}$ ; $V_{FB} = 1.5\text{V}$	1	1.5		mA
$I_b$	Source bias current			2.5	4	$\mu\text{A}$
	DC open loop gain	$R_L = \infty$	50	65		dB
$g_m$	Transconductance	$I_{COMP} = -0.1\text{mA}$ to $0.1\text{mA}$ ; $V_{COMP} = 1.9\text{V}$		2.3		mS

**Table 4. Electrical characteristics** ( $T_J = -40$  to  $85^\circ\text{C}$ ,  $V_{CC} = 12\text{V}$ , unless otherwise specified)

Symbol	Parameter	Test condition	Min	Typ	Max	Unit
<b>Synch function</b>						
	High input voltage	$V_{CC} = 4.4$ to $36\text{V}$ ;	2.5		$V_{REF}$	V
	Low input voltage	$V_{CC} = 4.4$ to $36\text{V}$ ;			0.74	V
	Slave synch current	$V_{synch} = 0.74\text{V}$ <sup>(1)</sup> $V_{synch} = 2.33\text{V}$	0.11 0.21		0.25 0.45	mA
	Master output amplitude	$I_{source} = 3\text{mA}$	2.75	3		V
	Output pulse width	no load, $V_{synch} = 1.65\text{V}$	0.20	0.35		$\mu\text{s}$
<b>Reference section</b>						
	Reference voltage	$I_{REF} = 0$ to $5\text{mA}$ $V_{CC} = 4.4\text{V}$ to $36\text{V}$	3.2	3.3	3.399	V
	Line regulation	$I_{REF} = 0\text{mA}$ $V_{CC} = 4.4\text{V}$ to $36\text{V}$		5	10	mV
	Load regulation	$I_{REF} = 0\text{mA}$		8	15	mV
	Short circuit current		10	18	30	mA

1. Guaranteed by design

## 4 Typical characteristics

**Figure 3. Junction temperature vs. output current**

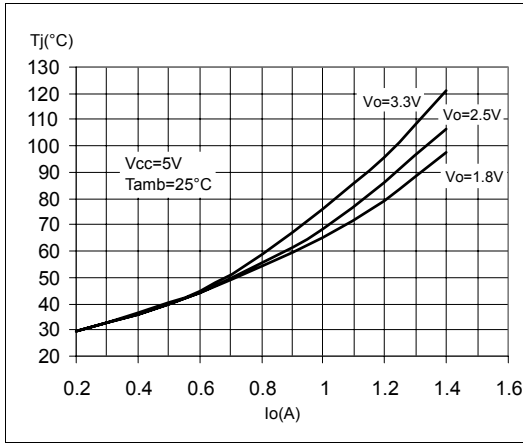

**Figure 4. Load regulator**

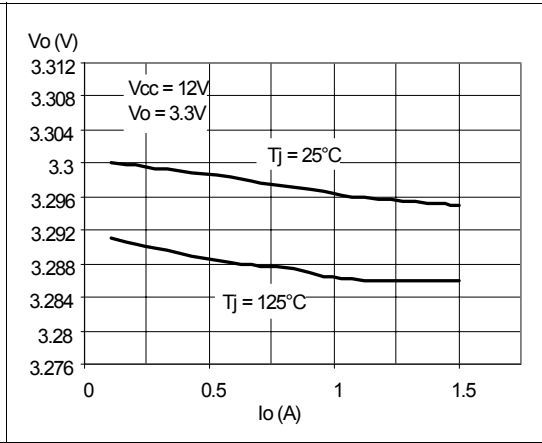

**Figure 5. Junction temperature vs. output current**

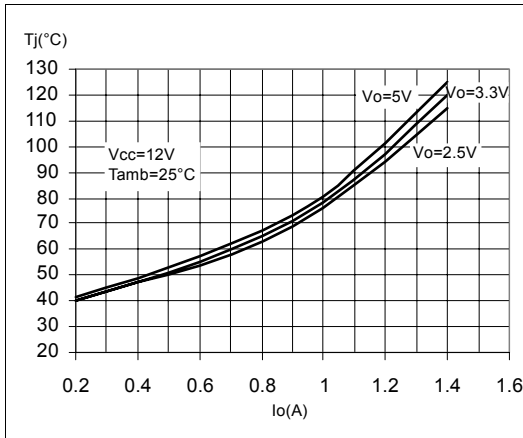

**Figure 6. Line regulator**

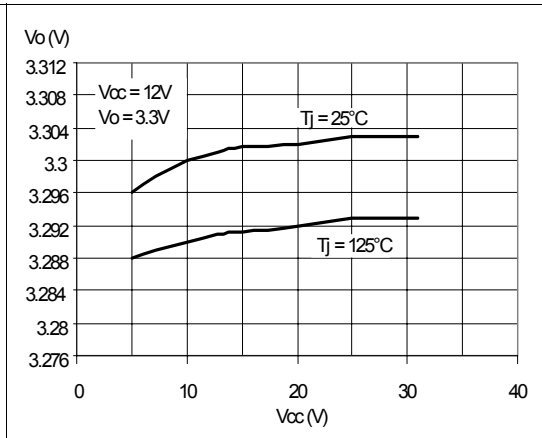

**Figure 7. Junction temperature vs. output current**

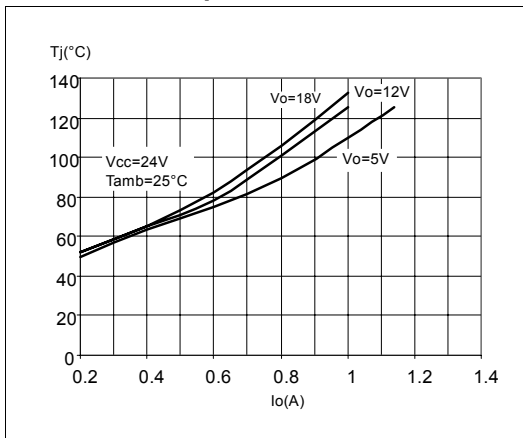

**Figure 8. Output voltage vs. junction temperature**

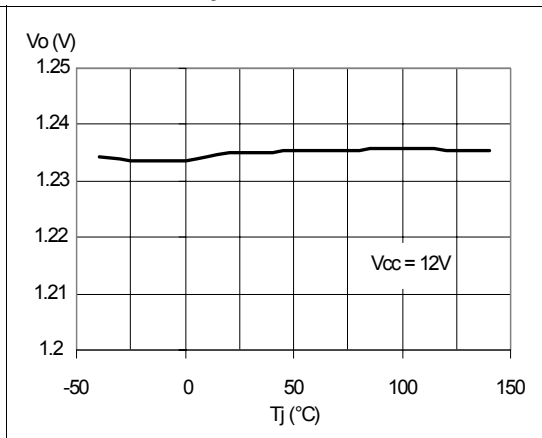

**Figure 9. Quiescent current vs. junction temperature**

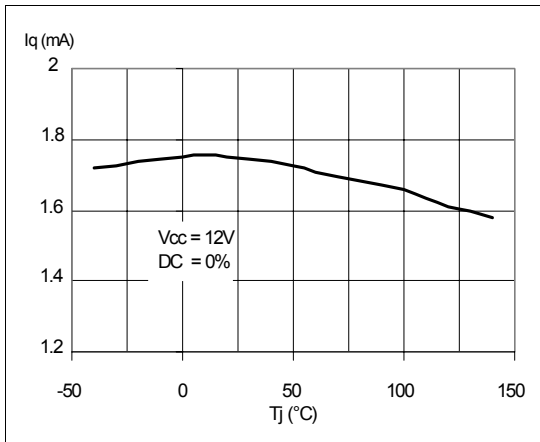

**Figure 10. Switching frequency vs. junction temperature**

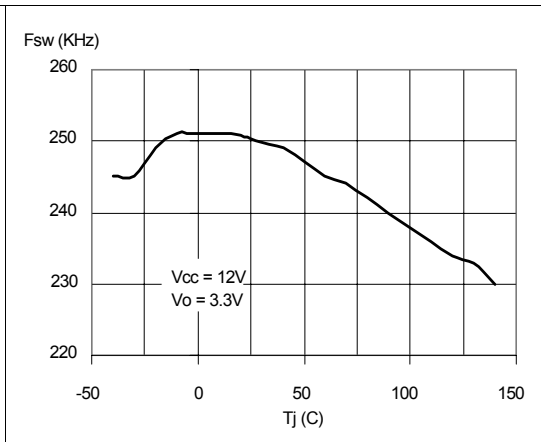

**Figure 11. Shutdown current vs. junction temperature**

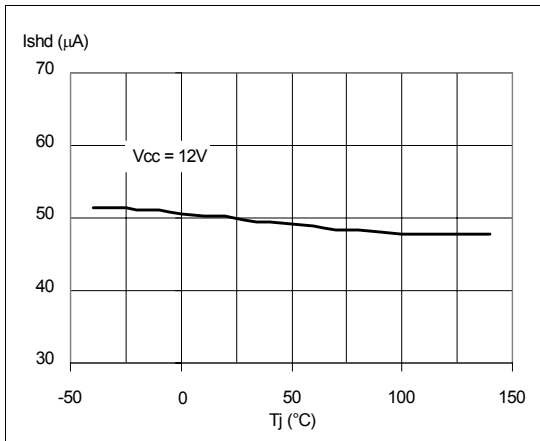

**Figure 12. Efficiency vs. output current**

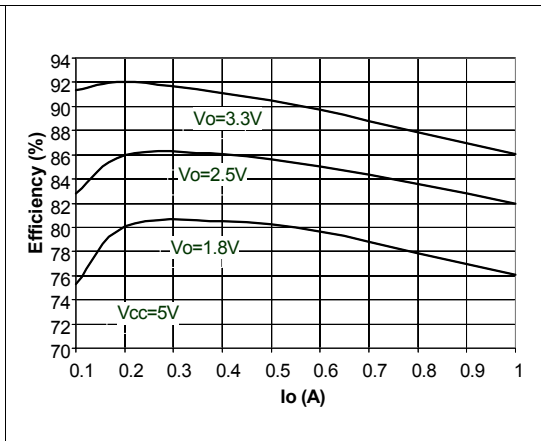

**Figure 13. Efficiency vs. output current**

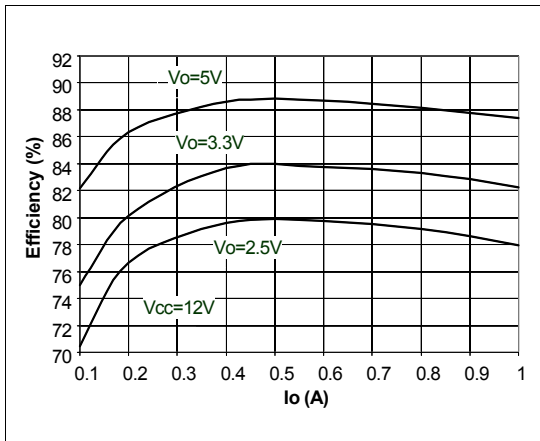



## 5 Package mechanical data

In order to meet environmental requirements, ST offers these devices in ECOPACK® packages. These packages have a Lead-free second level interconnect . The category of second level interconnect is marked on the package and on the inner box label, in compliance with JEDEC Standard JESD97. The maximum ratings related to soldering conditions are also marked on the inner box label. ECOPACK is an ST trademark. ECOPACK specifications are available at: [www.st.com](http://www.st.com)

Table 5. SO-8 mechanical data

Dim.	mm.			inch		
	Min	Typ	Max	Min	Typ	Max
A	1.35		1.75	0.053		0.069
A1	0.10		0.25	0.004		0.010
A2	1.10		1.65	0.043		0.065
B	0.33		0.51	0.013		0.020
C	0.19		0.25	0.007		0.010
D (1)	4.80		5.00	0.189		0.197
E	3.80		4.00	0.15		0.157
e		1.27			0.050	
H	5.80		6.20	0.228		0.244
h	0.25		0.50	0.010		0.020
L	0.40		1.27	0.016		0.050
k	0° (min.), 8° (max.)					
ddd			0.10			0.004

1. Dimensions D does not include mold flash, protrusions or gate burrs. Mold flash, protrusions or gate burrs shall not exceed 0.15mm (.006inch) in total (both side).

Figure 14. Package dimensions

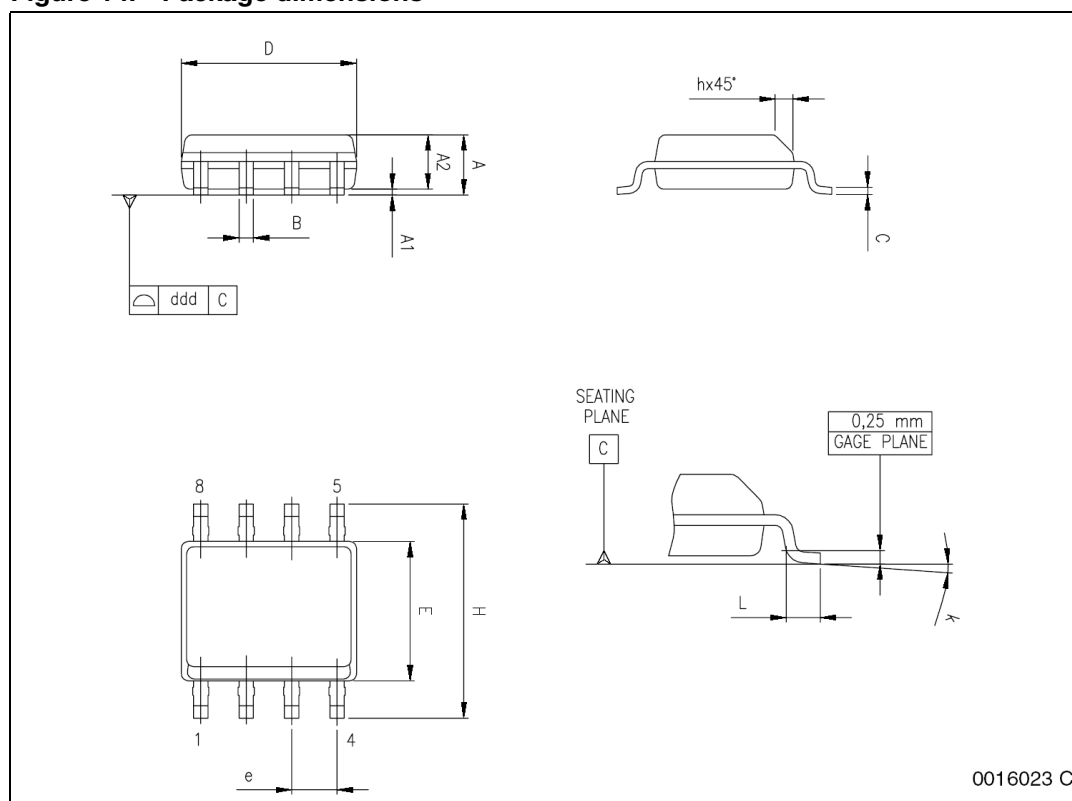

0016023 C

A5970D

---

## 6 Order codes

**Table 6. Order code**

Order code	Package	Packing
A5970D	SO-8	Tube
A5970D13TR		Tape and reel

## 7 Revision history

**Table 7. Document revision history**

Date	Revision	Changes
06-Aug-2007	1	Initial release.
24-Oct-2007	2	Updated: <a href="#">Table 4 on page 5</a>

## A5970D

---

### **Please Read Carefully:**

Information in this document is provided solely in connection with ST products. STMicroelectronics NV and its subsidiaries ("ST") reserve the right to make changes, corrections, modifications or improvements, to this document, and the products and services described herein at any time, without notice.

All ST products are sold pursuant to ST's terms and conditions of sale.

Purchasers are solely responsible for the choice, selection and use of the ST products and services described herein, and ST assumes no liability whatsoever relating to the choice, selection or use of the ST products and services described herein.

No license, express or implied, by estoppel or otherwise, to any intellectual property rights is granted under this document. If any part of this document refers to any third party products or services it shall not be deemed a license grant by ST for the use of such third party products or services, or any intellectual property contained therein or considered as a warranty covering the use in any manner whatsoever of such third party products or services or any intellectual property contained therein.

**UNLESS OTHERWISE SET FORTH IN ST'S TERMS AND CONDITIONS OF SALE ST DISCLAIMS ANY EXPRESS OR IMPLIED WARRANTY WITH RESPECT TO THE USE AND/OR SALE OF ST PRODUCTS INCLUDING WITHOUT LIMITATION IMPLIED WARRANTIES OF MERCHANTABILITY, FITNESS FOR A PARTICULAR PURPOSE (AND THEIR EQUIVALENTS UNDER THE LAWS OF ANY JURISDICTION), OR INFRINGEMENT OF ANY PATENT, COPYRIGHT OR OTHER INTELLECTUAL PROPERTY RIGHT.**

**UNLESS EXPRESSLY APPROVED IN WRITING BY AN AUTHORIZED ST REPRESENTATIVE, ST PRODUCTS ARE NOT RECOMMENDED, AUTHORIZED OR WARRANTED FOR USE IN MILITARY, AIR CRAFT, SPACE, LIFE SAVING, OR LIFE SUSTAINING APPLICATIONS, NOR IN PRODUCTS OR SYSTEMS WHERE FAILURE OR MALFUNCTION MAY RESULT IN PERSONAL INJURY, DEATH, OR SEVERE PROPERTY OR ENVIRONMENTAL DAMAGE. ST PRODUCTS WHICH ARE NOT SPECIFIED AS "AUTOMOTIVE GRADE" MAY ONLY BE USED IN AUTOMOTIVE APPLICATIONS AT USER'S OWN RISK.**

Resale of ST products with provisions different from the statements and/or technical features set forth in this document shall immediately void any warranty granted by ST for the ST product or service described herein and shall not create or extend in any manner whatsoever, any liability of ST.

ST and the ST logo are trademarks or registered trademarks of ST in various countries.

Information in this document supersedes and replaces all information previously supplied.

The ST logo is a registered trademark of STMicroelectronics. All other names are the property of their respective owners.

© 2007 STMicroelectronics - All rights reserved

STMicroelectronics group of companies

Australia - Belgium - Brazil - Canada - China - Czech Republic - Finland - France - Germany - Hong Kong - India - Israel - Italy - Japan - Malaysia - Malta - Morocco - Singapore - Spain - Sweden - Switzerland - United Kingdom - United States of America

[www.st.com](http://www.st.com)

