

# DATA SHEET

**TDA5241**

Brushless DC motor drive circuit

Product specification  
File under Integrated Circuits, IC01

November 96

# Brushless DC motor drive circuit

# TDA5241

## FEATURES

- Full-wave commutation (using push/pull drivers at the output stages) without position sensors
- Built-in start-up circuit
- Optimum commutation independent on motor type or motor loading
- Built-in flyback diodes
- Three push-pull outputs:
  - 0.85 A output current
  - built-in current limiter
- Thermal protection
- Low current consumption by adaptative base-drive
- Tacho output without extra sensor.
- Comparator for external position generator (PG) signal
- Built-in multiplexer combining internal FG and external PG signal on one pin for easy use with a controlling microprocessor
- Linear control of the output stages
- PG signal output.

## APPLICATIONS

- General purpose spindle driver ( e.g. VCR scanner motor).

## GENERAL DESCRIPTION

The TDA5241 is a bipolar integrated circuit used to drive brushless DC motors in full-wave mode. The device senses the rotor position using an EMF-sensing technique and is ideally suited as a drive circuit for VCR scanner motors.

## QUICK REFERENCE DATA

Measured over full voltage and temperature ranges

SYMBOL	PARAMETER	MIN.	TYP.	MAX.	UNIT
V <sub>P</sub>	supply voltage range (note 1)	4	–	18	V
I <sub>LIM</sub>	current limiting	0.6	0.85	1	A
V <sub>O</sub>	output voltage at I <sub>O</sub> = 100 mA(Upper+Lower transistor)	–	0.93	1.05	V

### Note

1. An unstabilized supply can be used ; Transients of 2 V allowed with max slope 0.1 V/μs.

Brushless DC motor drive circuit

TDA5241

ORDERING INFORMATION

TYPE NUMBER	PACKAGE		
	NAME	DESCRIPTION	VERSION
TDA5241	DIP18	plastic dual in-line package; 18 leads (300 mil); slim corner leads; long body	SOT102RG4

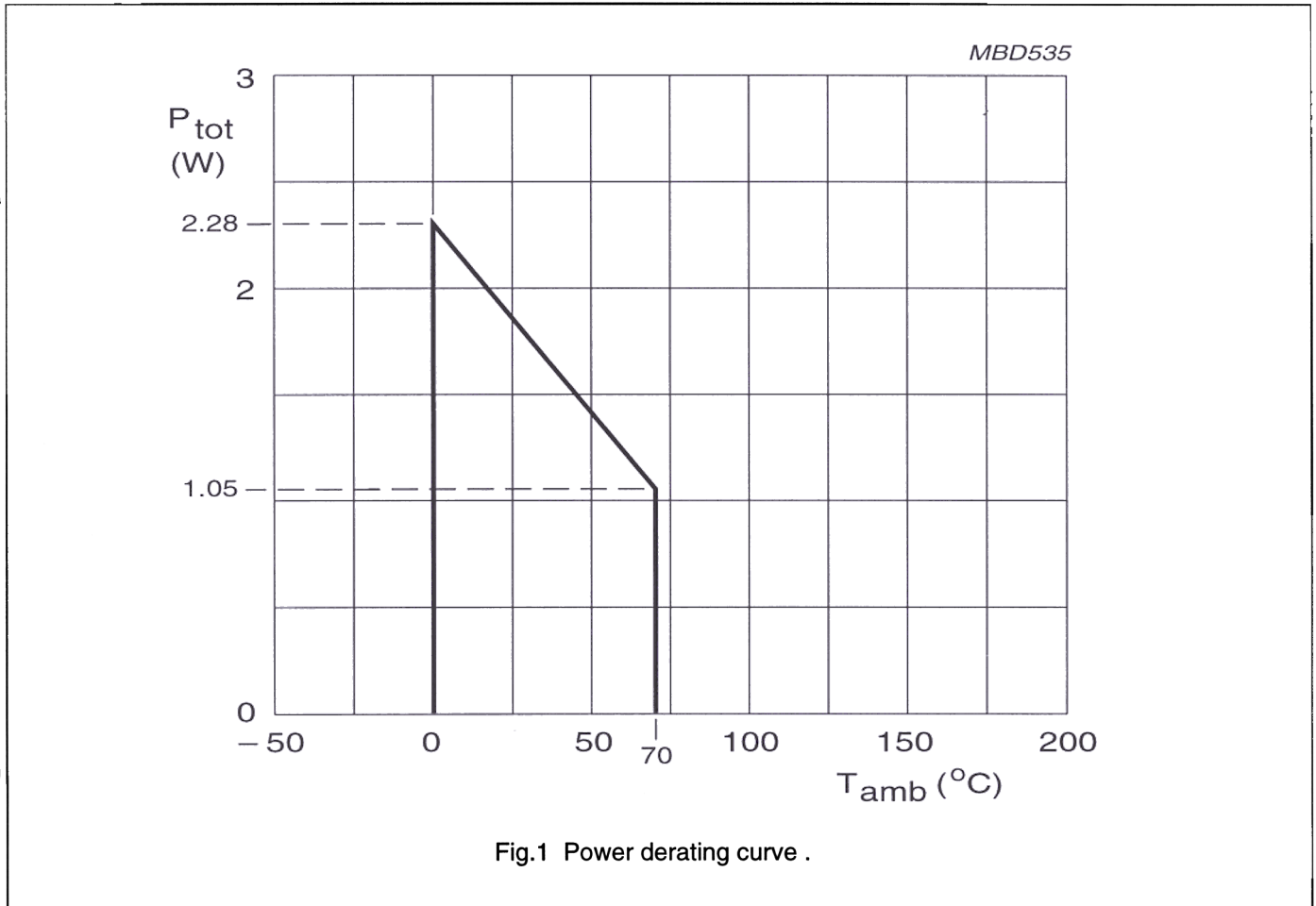

Brushless DC motor drive circuit

TDA5241

BLOCK DIAGRAM

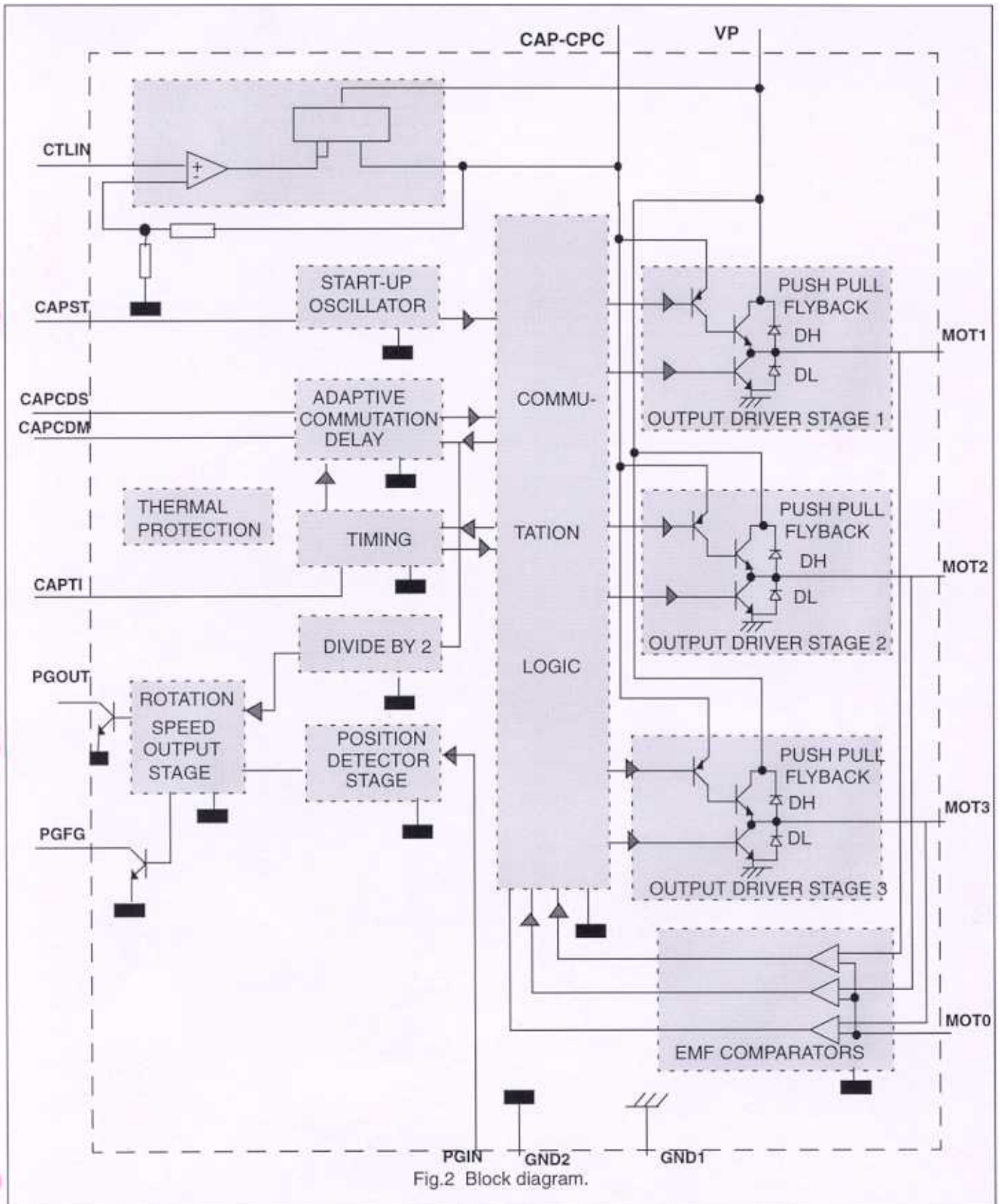

Fig.2 Block diagram.

Brushless DC motor drive circuit

TDA5241

PINNING

SYMBOL	PIN	DESCRIPTION
GND1	1	ground (0 V) motor supply return for output stages
n.c.	2	not connected
MOT2	3	driver output 2
V <sub>P</sub>	4	positive supply voltage
PGIN	5	position generator: input from the position detector sensor to the position detector stage (optional)
FGPG	6	FG/PG (open collector)
GND2	7	ground supply return for control circuits
PGOUT	8	position generator output of the position detector stage
CAP-CDM	9	external capacitor connection for commutation delay timing
CAP-CDS	10	external capacitor connection for commutation delay timing copy
CAP-ST	11	external capacitor connection for start-up oscillator
CAP-TI	12	external capacitor connection for timing
CTL IN	13	non-inverting input of the control amplifier
MOT0	14	input from the start point of the motor coils
CAP-CPC	15	external capacitor for stability of control loop
MOT3	16	driver output 3
n.c.	17	not connected
MOT1	18	driver output 1

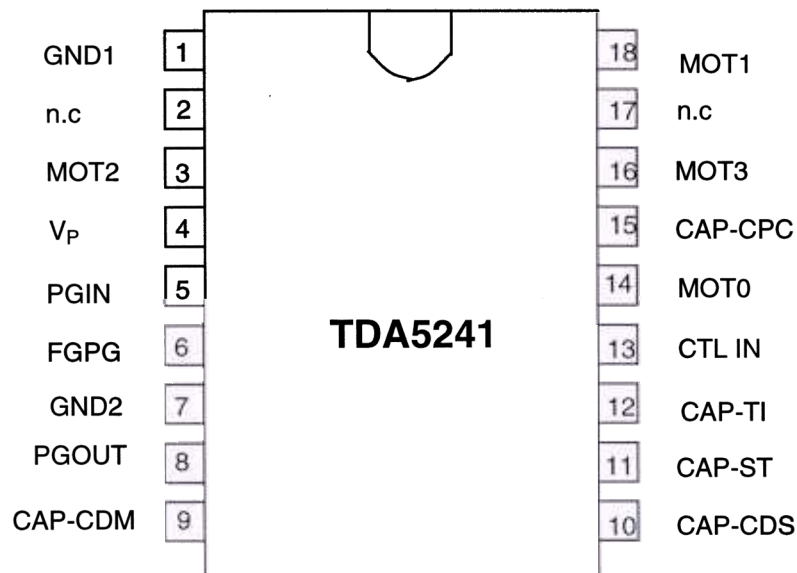

Fig.3 Pin configuration.

## Brushless DC motor drive circuit

## TDA5241

**FUNCTIONAL DESCRIPTION**

The TDA5241 offers a sensorless three phase motor drive function. It is unique in its combination of sensorless motor drive and full-wave drive.

The TDA5241 offers protected outputs capable of handling high currents and can be used with star or delta connected motors. It can easily be adapted for different motors and applications.

The TDA5241 offers the following features:

- Sensorless commutation by using the motor EMF
- Built-in start-up circuit
- Optimum commutation, independent of motor type or motor loading
- Built-in flyback diodes
- Three phase full-wave drive
- High output current (0.85 A)
- Outputs protected by current limiting and thermal protection of each output transistor
- Low current consumption by adaptive base-drive
- Accurate frequency generator (FG) by using the motor EMF
- Comparator for external position generator (PG) signal
- Built-in multiplexer combining internal FG and external PG signals on one pin for easy use with a controlling microprocessor
- Linear control of the output stages.

**LIMITING VALUES**

In accordance with the Absolute Maximum Rating System (IEC 134).

SYMBOL	PARAMETER	MIN.	MAX.	UNIT
$V_P$	supply voltage	–	18	V
$V_I$	input voltage; all pins except $V_P$ ( $V_I < 8$ V)	–0.3	$V_P + 0.5$	V
$V_O$	output voltage; PGOUT and PG/FG	GND	$V_P$	V
$V_O$	output voltage; MOT0, MOT1, MOT2 and MOT3	–1	$V_P + V_D$	V
$V_I$	input voltage; CAP-ST, CAP-TI, CAP-CD and CAP-DC	–	2.5	V
$P_{tot}$	total power dissipation	–	see power derating curve	–
$T_{stg}$	storage temperature range	–55	+150	°C
$T_{amb}$	operating ambient temperature range	–10	+70	°C

## Brushless DC motor drive circuit

## TDA5241

**CHARACTERISTICS**

$V_P = 14.5 \text{ V} \pm 10\%$ ;  $T_{\text{amb}} = -10 \text{ }^\circ\text{C}$  to  $70 \text{ }^\circ\text{C}$ , unless otherwise specified

Symbol	Parameter	Conditions	Min	Typ	Max	Unit
<b>Supply</b>						
$V_P$	Supply voltage range	note 1	4	–	18	V
$I_P$	Input current range	note 2	–	5.3	7	mA
<b>Thermal protection</b>						
$T_{SD}$	Local temperature at temperature sensor causing shut-down		130	140	150	$^\circ\text{C}$
$\Delta T$	Reduction in temperature before switch-on	after shut-down	–	$T_{SD}-30$	–	$^\circ\text{C}$
<b>MOT0 – CENTER TAP</b>						
$V_I$	Input voltage range		–0.5	–	$V_P$	V
$I_I$	Input bias current	$0.5 \text{ V} < V_I < V_P - 1.5 \text{ V}$	–10	–	–	$\mu\text{A}$
$V_{CSW}$	Comparator Switching Level	note 3	20	30	40	mV
$\Delta V_{CS}$	Variations in comparator switching levels		–3	0	+3	mV
$V_H$	Comparator input hysteresis		–	75	–	$\mu\text{V}$
<b>MOT1, MOT2 AND MOT3</b>						
$V_{DO}$	Voltage drop at $25 \text{ }^\circ\text{C}$ ( $V_{\text{out}}$ upper stage + $V_{\text{out}}$ lower stage)	$I_O = 100 \text{ mA}$	–	0.93	1.05	V
		$I_O = 500 \text{ mA}$	–	1.65	1.9	
$\Delta V_{OL}$	Variation in voltage between lower transistors	in control mode; $I_O = 100 \text{ mA}$	–	–	150	mV
$\Delta V_{OH}$	Variation in voltage between upper transistors	in control mode; $I_O = -100 \text{ mA}$	–	–	150	mV
$I_{LIM}$	Current limiting	$12 \text{ V}/6.8\Omega$	0.6	0.85	1	A
$V_{DHF}$	Diode forward voltage (DH)	notes 4 and 5; see Fig. 2; $I_O = -500 \text{ mA}$	–	–	1.5	V
$V_{DLF}$	Diode forward voltage (DL)	notes 4 and 5; see Fig. 2; $I_O = 500 \text{ mA}$	–1.5	–	–	V
$I_{DM}$	Peak diode current	note 5	–	–	1	A
<b>CTL IN</b>						
$V_{CTLIN}$	Input voltage range		0	–	$V_P$	V
$V_{CTLIN0}$	Offset voltage	See Fig. 6 $V_{CAPCPC} \leq 1.1 \text{ V}$	0.7	–	–	V
$G_{TRAN}$	Transfer gain	$CAP-CPC = 100 \text{ nF}$ $V_{CTLIN} = 1.5 \text{ V}$ and $V_{CTLIN} = 3 \text{ V}$	4.5	5	5.5	V/V
<b>PG IN</b>						
$V_I$	Input voltage range		–0.3	–	+5	V
$I_B$	Input bias current		–	–	650	nA
$R_I$	Input resistance		5	–	30	k $\Omega$
$V_{CSW}$	Comparator switching level		86	93	107	mV
$+/-V_{IAMP}$	Comparator input hysteresis		–	8	–	mV

## Brushless DC motor drive circuit

## TDA5241

Symbol	Parameter	Conditions	Min	Typ	Max	Unit
<b>PG OUT (open collector)</b>						
$V_{OL}$	Output voltage LOW	$I_O = 1.6 \text{ mA}$	–	–	0.4	V
$V_{OHmax}$	Output voltage HIGH		–	–	$V_P$	V
$t_{THL}$	Transition time	HIGH-to-LOW; CL = 50 pF; RL = 10 k $\Omega$	–	0.5	–	$\mu\text{s}$
$t_{PL}$	Pulse width LOW		4	–	10	$\mu\text{s}$
<b>FG/PG (open collector)</b>						
$V_{OL}$	Output voltage LOW	$I_O = 1.6 \text{ mA}$	–	–	0.4	V
$V_{OHmax}$	Maximum output voltage HIGH		–	–	$V_P$	V
$t_{THL}$	Transition time	HIGH-to-LOW CL = 50 pF RL = 10 k $\Omega$	–	0.5	–	$\mu\text{s}$
	Ratio of FG frequency and commutation frequency		–	1:2	–	–
$\delta$	Duty factor		–	50	–	%
$t_{PL}$	Pulse width LOW	after a PG IN pulse	5	7	15	$\mu\text{s}$
<b>CAP-ST</b>						
$I_I$	Output sink current		1.5	2.0	2.5	$\mu\text{A}$
$I_O$	Output source current		–2.5	–2.0	–1.5	$\mu\text{A}$
$V_{SWL}$	Lower switching level		–	0.20	–	V
$V_{SWM}$	Middle switching level		–	0.30	–	V
$V_{SWH}$	Upper switching level		–	2.20	–	V
<b>CAP-TI</b>						
$I_I$	Output sink current		22	30	38	$\mu\text{A}$
$I_{OH}$	Output source current HIGH		–70	–63	–56	$\mu\text{A}$
$I_{OL}$	Lower source current LOW		–6.0	–5.3	–4.6	$\mu\text{A}$
$V_{SWL}$	Lower switching level		–	50	–	mV
$V_{SWM}$	Middle switching level		–	0.30	–	V
$V_{SWH}$	Upper switching level		–	2.20	–	V
<b>CAP-CDM</b>						
$I_I$	Output sink current		10.6	16.2	22	$\mu\text{A}$
$I_O$	Output source current		–5.3	–8.1	–11	$\mu\text{A}$
$I_I/I_O$	Ratio of sink to source current		1.85	2.05	2.25	
$V_{IL}$	Input voltage level LOW		780	860	940	mV
$V_{IH}$	Input voltage level HIGH		2.3	2.4	2.55	V



# Brushless DC motor drive circuit

# TDA5241

Symbol	Parameter	Conditions	Min	Typ	Max	Unit
<b>CAP-CDS</b>						
$I_I$	Output sink current		10.1	15.5	20.9	$\mu\text{A}$
$I_O$	Output source current		-20.9	-15.5	-10.1	$\mu\text{A}$
$I_I/I_O$	Ratio of sink to source current		0.9	1.025	1.15	
$V_{IL}$	Input voltage level LOW		780	860	940	mV
$V_{IH}$	Input voltage level HIGH		2.3	2.4	2.55	V
<b>CAP-CPC</b>						
$I_I$	Output sink current		1	-	3	mA
$I_O$	Output source current		-100	-	-30	$\mu\text{A}$

**NOTES:**

1. An unstabilized supply can be used; transients of 2 V allowed with max slope 0.1 V/ $\mu\text{s}$ .
2. All other inputs at 0V; all outputs at  $V_P$  and  $I_O = 0 \mu\text{A}$ .
3. Switching levels with respect to MOT1, MOT2 and MOT3.
4. Drivers are in high impedance OFF-state.
5. The outputs are short-circuit protected by limiting the current and the IC temperature.

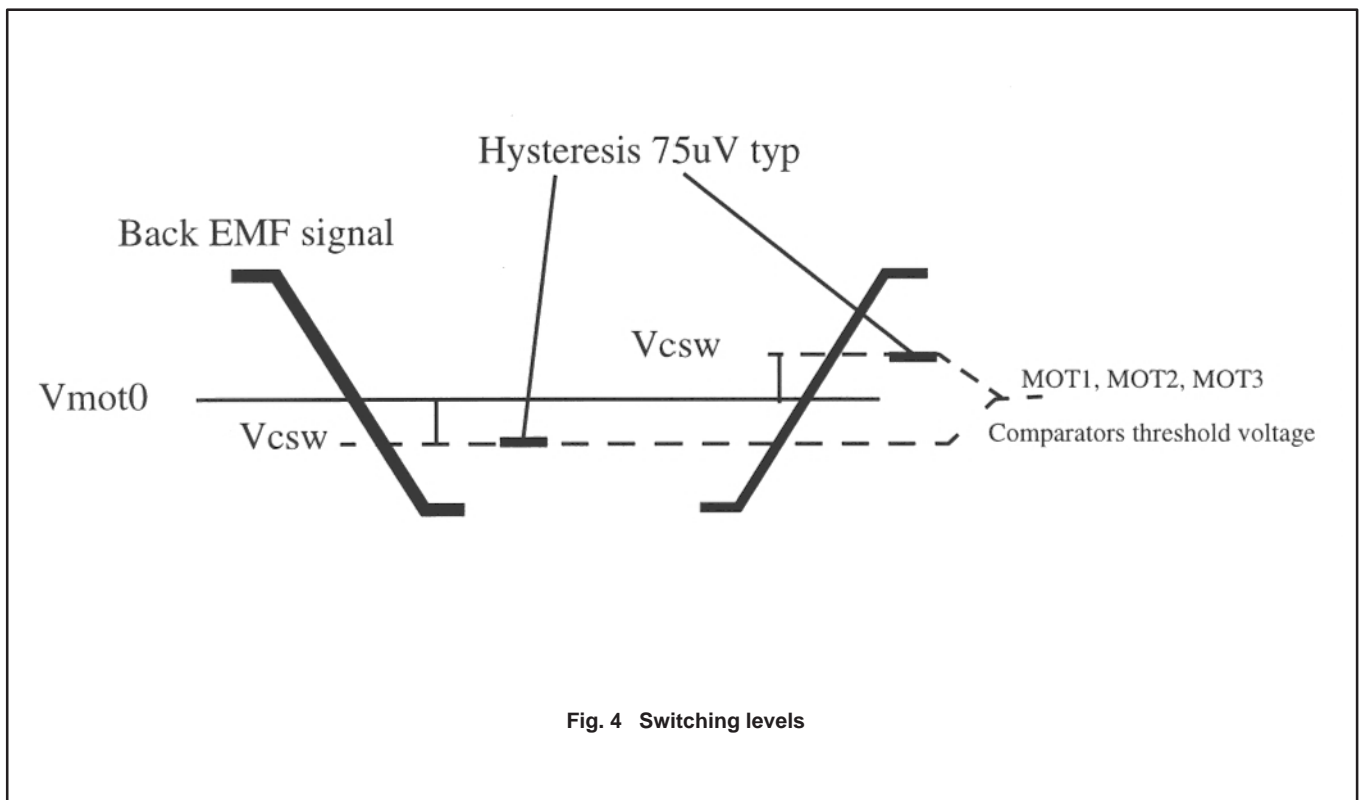

## Brushless DC motor drive circuit

TDA5241

## APPLICATION INFORMATION

## Introduction

Figure 5 shows full-wave driving of a three phase motor requires three push-pull output stages. In each of the six possible states two outputs are active, one sourcing and one sinking current. The third output presents a high impedance to the motor which enables measurement of the motor EMF in the corresponding motor coil by the EMF comparator at each output. The commutation logic is responsible for control of the output transistors and selection of the correct EMF comparator.

The zero-crossing in the motor EMF (detected by the comparator selected by the commutation logic) is used to calculate the correct moment for the next commutation, that is, the change to the next output state. The delay is calculated (depending on the motor loading) by the adaptive commutation delay block.

Because of high inductive loading the output stages contain flyback diodes. The output stages are also protected by a current limiting circuit and by thermal protection of the six output transistors.

The zero-crossings can be used to provide speed information such as the tacho signal FG. A VCR scanner also requires a PG phase sensor. This circuit has an interface for a simple pick-up coil. A multiplexer circuit is also provided to combine the FG and PG signals in time. The TDA 5240 is providing 1 multiplexed FG PG signal: pin7 (SO20) FG-PG 3 times the number of pole pairs. A PG output signal is generated; pulse width is typically 7  $\mu$ s.

Table 1 OUTPUT STATES

STATE	MOT1	MOT2	MOT3
1	Z	L	H
2	H	L	Z
3	H	Z	L
4	Z	H	L
5	L	H	Z
6	L	Z	H

In Table1 , the sequence of the six possible states of the outputs has been depicted

Brushless DC motor drive circuit

TDA5241

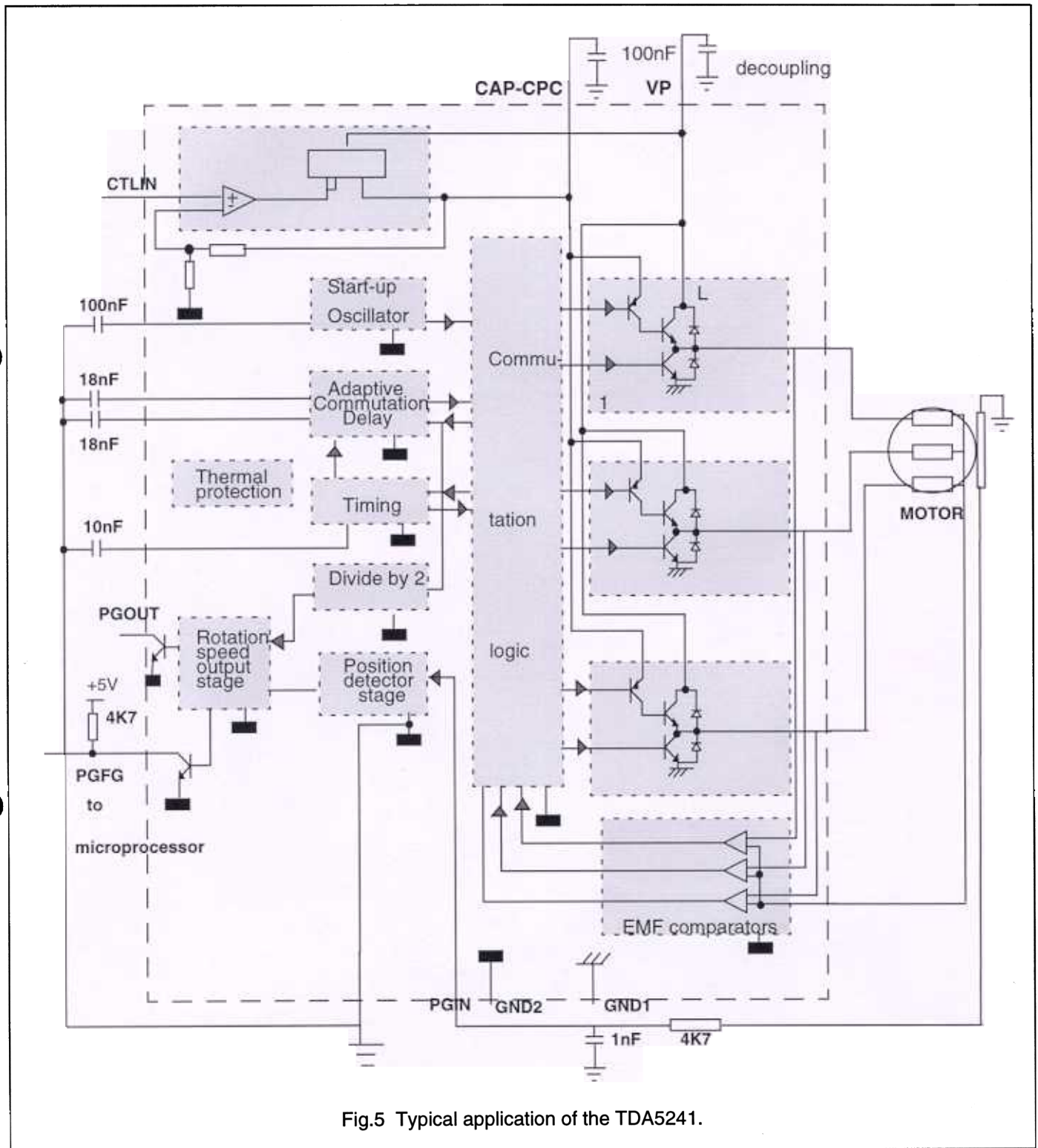
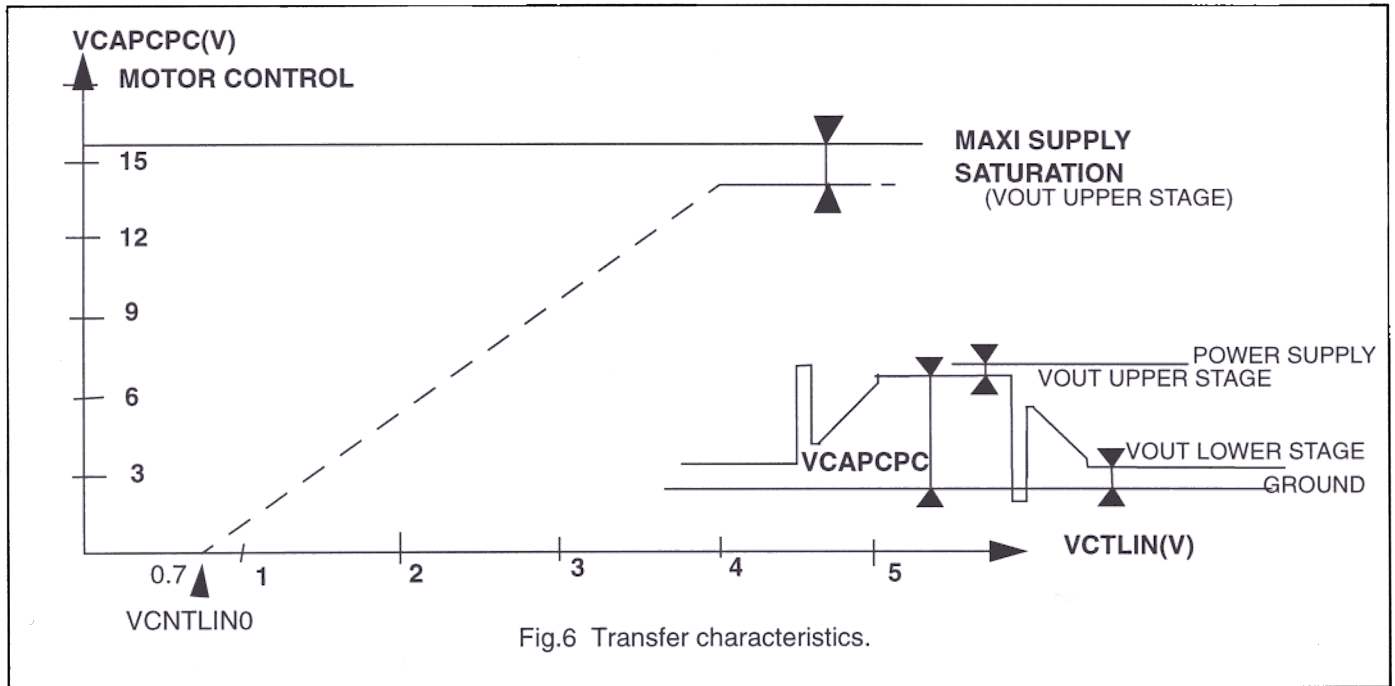

Fig.5 Typical application of the TDA5241.

## Brushless DC motor drive circuit

TDA5241



Analog control of the motor output voltages is achieved by an internal operational amplifier which transfer gain is internally fixed. Compensation of the motor pole is done by an external capacitor (CAP CPC).

Both grounds GND1 and GND2 must be connected together.

#### ADJUSTMENTS

The system has been designed in such a way that the tolerances of the application components are not critical. However, the approximate values of the following components must still be determined:

- The start capacitor; this determines the frequency of the start oscillator
- The two capacitors in the adaptive commutation delay circuit. These are important in determining the optimum moment for commutation, depending on the type and loading of the motor
- The timing capacitor; this provides the system with its timing signals

(This deals with the application note AN94070)

#### THE START CAPACITORS (CAP-ST)

This capacitor determines the frequency of the start oscillator. It is charged and discharged, with a current of 2  $\mu$ A, from 0.05 to 2.2 V and back to 0.05 V. The time taken to complete one cycle is given by:

$$t_{\text{start}} = (2.15 \times C)\text{s} \quad (\text{with } C \text{ in } \mu\text{F})$$

The start oscillator is reset by a commutation pulse and so is only active when the system is in the start-up mode. A pulse from the start oscillator will cause the outputs to change to the next state (torque in the motor). If the movement of the motor generates enough EMF the TDA5241 will run the motor. If the amount of EMF generated is insufficient, then the motor will move one step only and will oscillate in its new position.

The amplitude of the oscillation must decrease sufficiently before the arrival of the next start pulse, to prevent the pulse arriving during the wrong phase of the oscillation. The oscillation of the motor is given by:

## Brushless DC motor drive circuit

## TDA5241

$$f_{osc} = \frac{0.5}{\pi} \times \left( K_t \times I \times \frac{p}{J} \right)^{\frac{1}{2}}$$

where:

$K_t$  = torque constant (N.m/A)

$I$  = current (A)

$p$  = number of magnetic pole-pairs

$J$  = inertia J (kg/m<sup>2</sup>)

Example:  $J = 72 \times 10^{-6}$  kg/m<sup>2</sup>,  $K = 25 \times 10^{-3}$  N.m/A,  $p = 6$  and  $I = 0.5$  A; this gives  $f_{osc} = 5$  Hz. If the damping is high then a start frequency of 2 Hz can be chosen or  $t = 500$  ms, thus  $C = 0.5/2 = 0.25$   $\mu$ F, (choose 220 nF).

#### THE ADAPTIVE COMMUTATION DELAY (CAP-CDM AND CAP-CDS)

In this circuit capacitor CAP-CDM is charged during one commutation period, with an interruption of the charging current during the diode pulse. During the next commutation period this capacitor (CAP-CDM) is discharged at twice the charging current. The charging current is 8.1  $\mu$ A and the discharging current 16.2  $\mu$ A; the voltage range is from 0.9 to 2.2 V. The voltage must stay within this range at the lowest commutation frequency of interest,  $f_{C1}$ :

$$C = \frac{8.1}{f \times 1.3} \times 10^{-5} = \frac{6231}{f_{C1}} \quad (C \text{ in nF})$$

If the frequency is lower, then a constant commutation delay after the zero-crossing is generated by the discharge from 2.2 to 0.9 V at 16.2  $\mu$ A.

$$\text{maximum delay} = (0.076 \times C) \text{ ms (with } C \text{ in nF)}$$

Example: nominal commutation frequency = 900 Hz and the lowest usable frequency = 400 Hz, so:

$$\text{CAP-CDM} = \frac{6231}{400} = 15.6 \quad (\text{choose } 18 \text{ nF})$$

The other capacitor, CAP-CDS, is used to repeat the same delay by charging and discharging with 20  $\mu$ A.

The same value can be chosen as for CAP-CDM. Figure 7 illustrates typical voltage waveforms

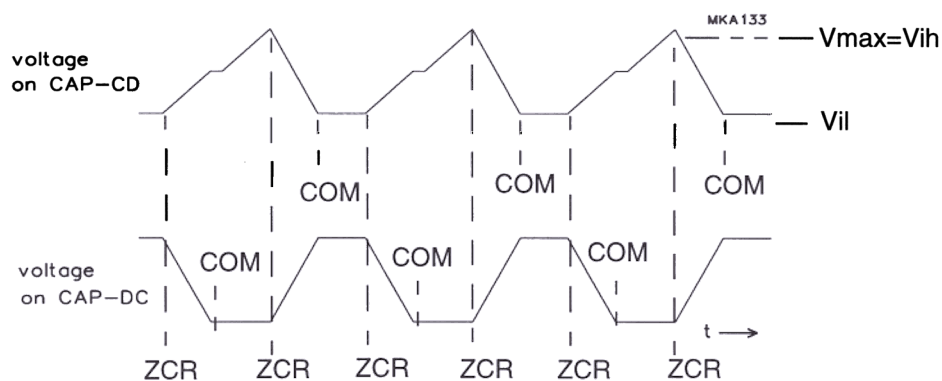

Fig.7 CAP-CD and CAP-DC typical voltage waveforms in normal running mode.  
(ZCR = Zero-crossing ; COM = COMMUTATION)

## Brushless DC motor drive circuit

TDA5241

## THE TIMING CAPACITOR (CAP-TI)

Capacitor CAP-TI is used for timing the successive steps within one commutation period; these steps include some internal delays.

The most important function is the watchdog time in which the motor EMF has to recover from a negative diode-pulse back to a positive EMF voltage (or vice versa). A watchdog timer is a guarding function that only becomes active when the expected event does not occur within a predetermined time.

The EMF usually recovers within a short time if the motor is running normally ( $\ll$  ms). However, if the motor is motionless or rotating in the reverse direction, then the time can be longer ( $\gg$  ms).

A watchdog time must be chosen so that it is long enough for a motor without EMF (still) and eddy currents that may stretch the voltage in a motor winding; however, it must be short enough to detect reverse rotation. If the watchdog time is made too long, then the motor may run in the wrong direction (with little torque).

The capacitor is charged, with a current of  $57 \mu\text{A}$ , from 0.2 to 0.3 V. Above this level it is charged, with a current of  $5 \mu\text{A}$ , up to 2.2 V only if the selected motor EMF remains in the wrong polarity (watchdog function). At the end, or, if the motor voltage becomes positive, the capacitor is discharged with a current of  $28 \mu\text{A}$ . The watchdog time is the time taken to charge the capacitor, with a current of  $5 \mu\text{A}$ , from 0.3 to 2.2 V. The value of CAP-TI is given by:

$$C = 5 \times 10^{-6} \times \frac{t_m}{1.9} = 2.63 t_m \quad (C \text{ in nF ; } t \text{ in ms})$$

Example: If after switching off, the voltage from a motor winding is reduced, in 3.5 ms, to within 20 mV (the offset of the EMF comparator), then the value of the required timing capacitor is given by:

$$C = 2.63 \times 3.5 = 9.2 \text{ (choose 10 nF)}$$

Typical voltage waveforms are illustrated by Fig. 8.

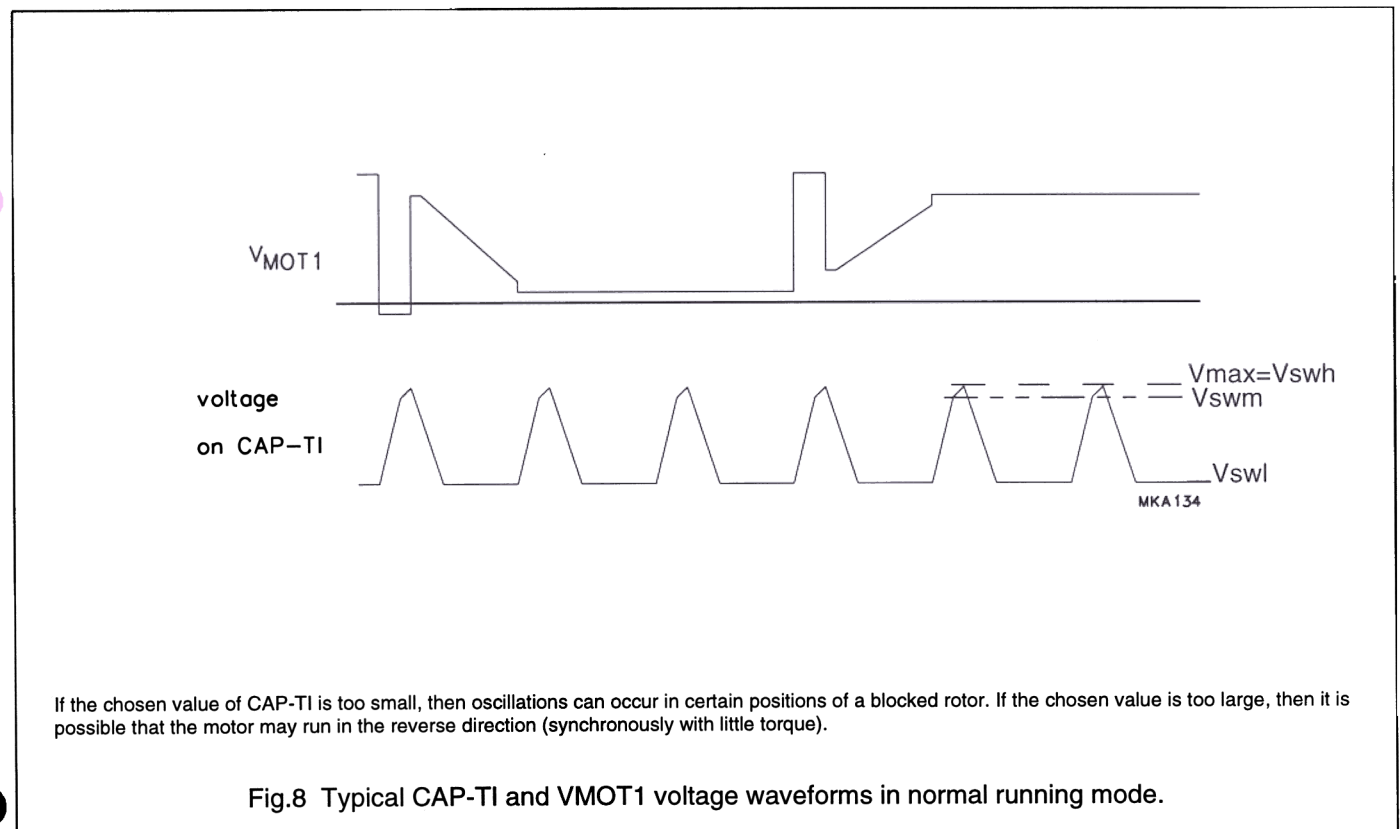

## Brushless DC motor drive circuit

## TDA5241

## OTHER DESIGN ASPECTS

There are other design aspects concerning the application of the TDA5241 besides the commutation function. They are:

- Generation of the tacho signal FG
- Built-in interface for a PG sensor
- Reliability.

## FG SIGNAL

The FG signal is generated in the TDA5241 by using the zero-crossing of the motor EMF from the three motor windings. Every zero-crossing in a (star connected) motor winding is used to toggle the FG output signal. The FG frequency is therefore half the commutation frequency. All transitions indicate the detection of a zero-crossing (except for PG). The negative-going edges are called FG pulses because they generate an interrupt in a controlling microprocessor.

The accuracy of the FG output signal (jitter) is very good. This accuracy depends on the symmetry of the motor's electromagnetic construction, which also effects the satisfactory functioning of the motor itself.

Two FG frequencies are given out : 6 times the number of poles pairs or 3 times the number of poles pairs. A pull-up resistor must be connected to PGFG outputs

Example: A three phase motor with 6 magnetic pole-pairs at 1500 rpm and with a full-wave drive has a commutation frequency of  $25 \times 6 \times 6 = 900$  Hz, and generates a tacho signal of 450 Hz.

## PG SIGNAL

The accuracy of the PG signal in applications such as VCR must be high (phase information. This accuracy is obtained by combining the accurate FG signal with the PG signal by using a wide tolerance external PG sensor. The external PG signal (PGIN) is only used as an indicator to select a particular FG pulse. This pulse differs from the other FG pulses in that a short LOW-time of 15  $\mu$ s after a HIGH to LOW transition. All other FG pulses have a 50% duty factor (see Fig. 9).

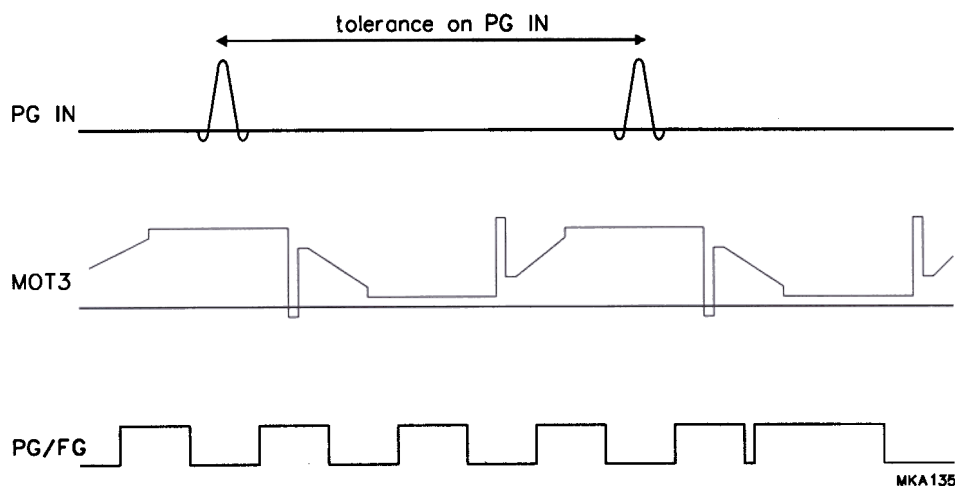

Fig.9 Timing and the FG and PG IN signals.

---

## Brushless DC motor drive circuit

## TDA5241

---

### RELIABILITY

It is necessary to protect high current circuits and the output stages are protected in two ways:

- Current limiting of the 'lower' output transistors. The 'upper' output transistors use the same base current as the conducting 'lower' transistor (+15%). This means that the current to and from the output stages is limited.
- Thermal protection of the six output transistors is achieved by each transistor having a thermal sensor that is active when the transistor is switched on. The transistors are switched off when the local temperature becomes too high.



Brushless DC motor drive circuit

TDA5241

PACKAGE OUTLINE

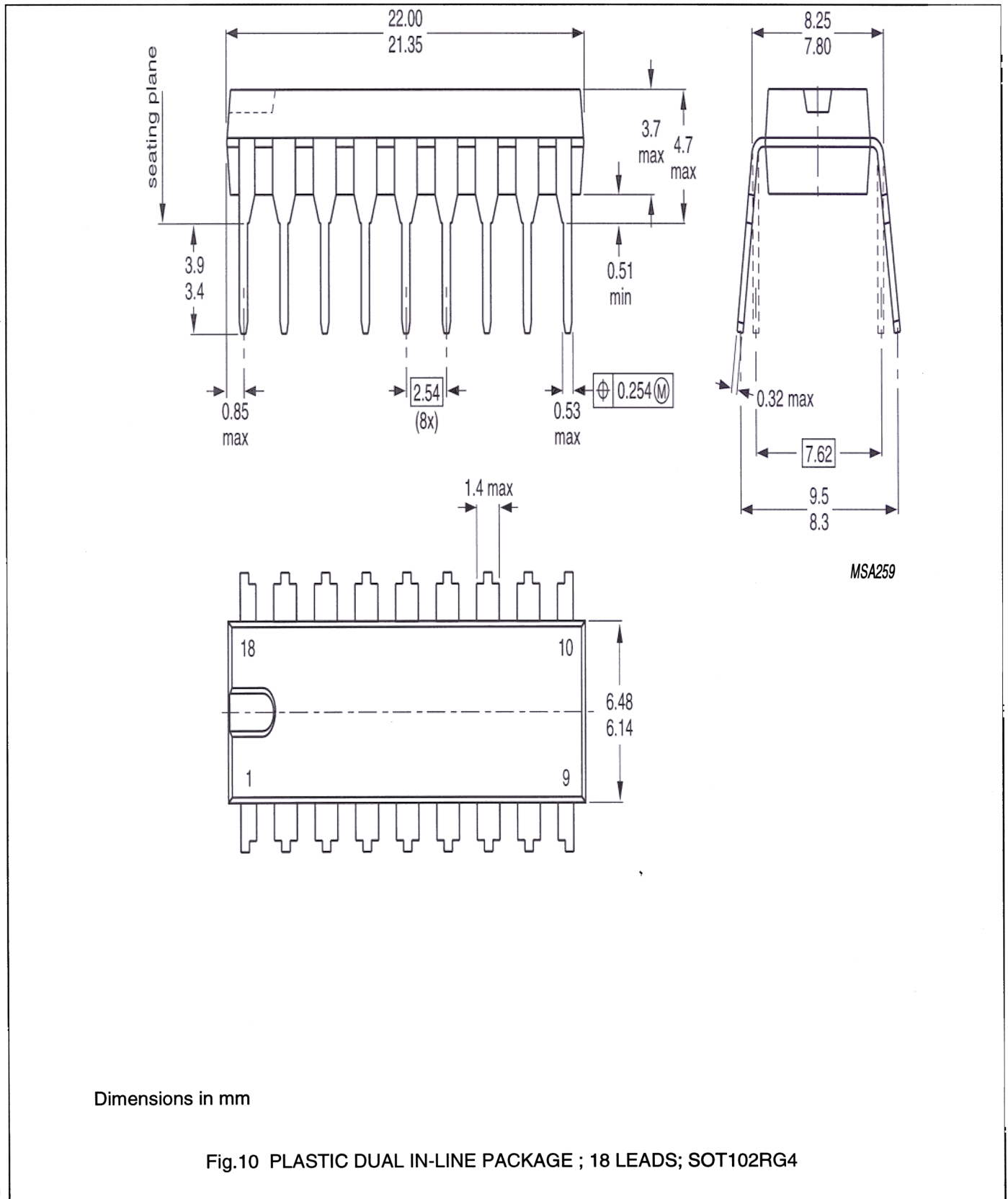

---

## Brushless DC motor drive circuit

TDA5241

---

### SOLDERING

#### Introduction

There is no soldering method that is ideal for all IC packages. Wave soldering is often preferred when through-hole and surface mounted components are mixed on one printed-circuit board. However, wave soldering is not always suitable for surface mounted ICs, or for printed-circuits with high population densities. In these situations reflow soldering is often used.

This text gives a very brief insight to a complex technology. A more in-depth account of soldering ICs can be found in our *"IC Package Databook"* (order code 9398 652 90011).

#### Reflow soldering

Reflow soldering techniques are suitable for all SO packages.

Reflow soldering requires solder paste (a suspension of fine solder particles, flux and binding agent) to be applied to the printed-circuit board by screen printing, stencilling or pressure-syringe dispensing before package placement.

Several techniques exist for reflowing; for example, thermal conduction by heated belt. Dwell times vary between 50 and 300 seconds depending on heating method. Typical reflow temperatures range from 215 to 250 °C.

Preheating is necessary to dry the paste and evaporate the binding agent. Preheating duration: 45 minutes at 45 °C.

#### Wave soldering

Wave soldering techniques can be used for all SO packages if the following conditions are observed:

- A double-wave (a turbulent wave with high upward pressure followed by a smooth laminar wave) soldering technique should be used.
- The longitudinal axis of the package footprint must be parallel to the solder flow.
- The package footprint must incorporate solder thieves at the downstream end.

During placement and before soldering, the package must be fixed with a droplet of adhesive. The adhesive can be applied by screen printing, pin transfer or syringe dispensing. The package can be soldered after the adhesive is cured.

Maximum permissible solder temperature is 260 °C, and maximum duration of package immersion in solder is 10 seconds, if cooled to less than 150 °C within 6 seconds. Typical dwell time is 4 seconds at 250 °C.

A mildly-activated flux will eliminate the need for removal of corrosive residues in most applications.

#### Repairing soldered joints

Fix the component by first soldering two diagonally- opposite end leads. Use only a low voltage soldering iron (less than 24 V) applied to the flat part of the lead. Contact time must be limited to 10 seconds at up to 300 °C. When using a dedicated tool, all other leads can be soldered in one operation within 2 to 5 seconds between 270 and 320 °C.

## Brushless DC motor drive circuit

TDA5241

## Data sheet status

Data sheet status <sup>[1]</sup>	Product status <sup>[2]</sup>	Definitions
Objective specification	Development	This data sheet contains data from the objective specification for product development. Philips Semiconductors reserves the right to change the specification in any manner without notice.
Preliminary specification	Qualification	This data sheet contains data from the preliminary specification. Supplementary data will be published at a later date. Philips Semiconductors reserves the right to change the specification without notice, in order to improve the design and supply the best possible product.
Product specification	Production	This data sheet contains data from the product specification. Philips Semiconductors reserves the right to make changes at any time in order to improve the design, manufacturing and supply. Changes will be communicated according to the Customer Product/Process Change Notification (CPCN) procedure SNW-SQ-650A.

[1] Please consult the most recently issued data sheet before initiating or completing a design.

[2] The product status of the device(s) described in this data sheet may have changed since this data sheet was published. The latest information is available on the Internet at URL <http://www.semiconductors.philips.com>.

## Definitions

**Short-form specification** — The data in a short-form specification is extracted from a full data sheet with the same type number and title. For detailed information see the relevant data sheet or data handbook.

**Limiting values definition** — Limiting values given are in accordance with the Absolute Maximum Rating System (IEC 60134). Stress above one or more of the limiting values may cause permanent damage to the device. These are stress ratings only and operation of the device at these or at any other conditions above those given in the Characteristics sections of the specification is not implied. Exposure to limiting values for extended periods may affect device reliability.

**Application information** — Applications that are described herein for any of these products are for illustrative purposes only. Philips Semiconductors make no representation or warranty that such applications will be suitable for the specified use without further testing or modification.

## Disclaimers

**Life support** — These products are not designed for use in life support appliances, devices or systems where malfunction of these products can reasonably be expected to result in personal injury. Philips Semiconductors customers using or selling these products for use in such applications do so at their own risk and agree to fully indemnify Philips Semiconductors for any damages resulting from such application.

**Right to make changes** — Philips Semiconductors reserves the right to make changes, without notice, in the products, including circuits, standard cells, and/or software, described or contained herein in order to improve design and/or performance. Philips Semiconductors assumes no responsibility or liability for the use of any of these products, conveys no license or title under any patent, copyright, or mask work right to these products, and makes no representations or warranties that these products are free from patent, copyright, or mask work right infringement, unless otherwise specified.

## Contact information

For additional information please visit  
<http://www.semiconductors.philips.com>. Fax: +31 40 27 24825

© Koninklijke Philips Electronics N.V. 1996  
 All rights reserved. Printed in U.S.A.

Date of release: 11-96

For sales offices addresses send e-mail to:  
[sales.addresses@www.semiconductors.philips.com](mailto:sales.addresses@www.semiconductors.philips.com)

Document order number:

9397 750 08755

*Let's make things better.*