

**Best Selection**

## Fiber Sensors

Best Selection Catalog

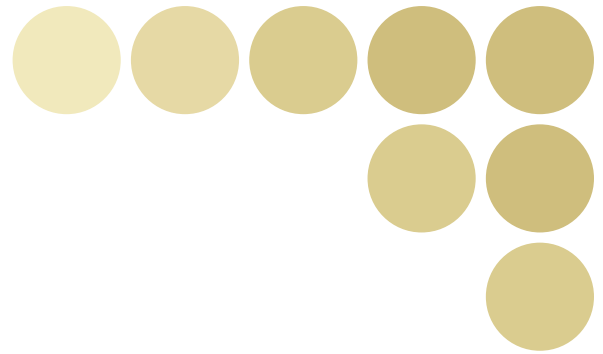

OMRON's Fiber Sensors continue to support an increasing range of applications.

This catalog brings you the latest information on our Fiber Units.



E32-series Fiber Units

Amplifier Units



E3X-DA-S/-MDA Series

E3X-NA Series

# Fiber Unit

## Standard Models

## First, Our Standard Lineup



These Fibers Units can be used in a variety of applications, such as detecting the presence of workpieces and positioning.

### A Wide Variety of Shapes for Adapting to Different Installation Locations

Choose the model that suits the installation space from a wide variety of shapes and sizes.



### Space Savings and Simple Mounting

#### Flat Models

Flat models that allow simple screw mounting and straightforward wiring have been added to the lineup. Using these models eliminates the problem of fibers getting caught on surrounding objects.



Flat model

### Detect Workpieces in Tight Spaces

#### Custom-produced Sleeves

Models with sleeves allow detection in tight spaces. We will perform the time-consuming task of fashioning the sleeve, with a length and bends to suit the space (except for ultrafine sleeves).

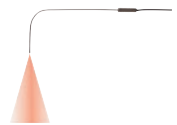

Models with sleeves

### Flexible, Pliable Fiber That Can Be Handled Like Wire

We have developed a broad range of fibers to meet a wide variety of needs. Multicore (flexible) fiber is a new type of standard fiber that can be used like wire without worrying about the bending radius. We have also produced fiber that will not break when used in moving parts and fiber that is not degraded by contact with oil.

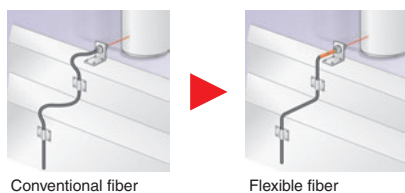

You will certainly appreciate the ease of use that flexible fiber ensures.

### Length Can Be Specified in 1-m Units

#### Saving Energy and Work

We will produce fiber of the required length (in meter units). For large-scale installations, specifications of up to 20 m can be handled. (Specifications of 0.3 m and 0.5 m are also possible.)





## Selection Guide

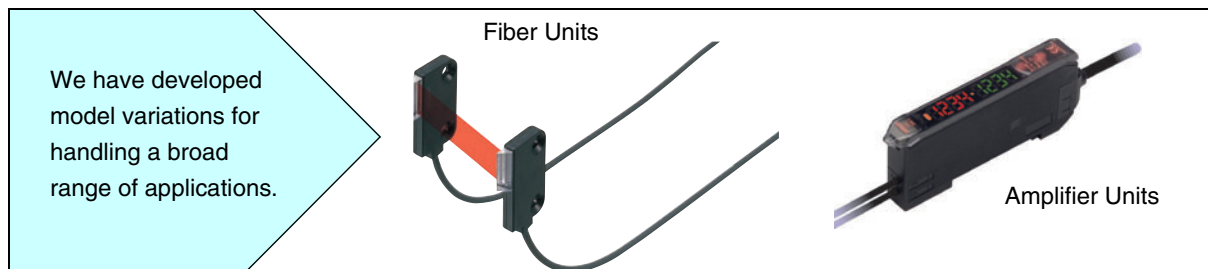

### Fiber Units

Detection conditions	Environmental conditions	
	Standard environments	Special environments
<b>Standard detection</b> <ul style="list-style-type: none"> <li>Workpiece presence</li> <li>Positioning</li> <li>Level differences and marks</li> </ul>	<b>Standard Models</b> ●●●▶ P.6 	<b>Environment-resistant Models</b> ●●●▶ P.14 
<b>Special-beam</b> <ul style="list-style-type: none"> <li>Long-distance sensing, resistance to dust and dirt</li> <li>Small beam, resistance to rattling</li> <li>Detection of transparent objects</li> </ul>	<b>Special-beam Models</b> ●●●▶ P.10 	
<b>Application-corresponding</b> <ul style="list-style-type: none"> <li>Labels</li> <li>Liquid level</li> <li>Alignment and mapping of glass substrates</li> <li>Water mapping</li> </ul>	<b>Application-corresponding Models</b> ●●●▶ P.16 	

### Amplifier Units

Type	Digital		Manual
Appearance		2-channel models	
Response time	48 μs, 1 ms, or 4 ms (2-output models: 80 μs, 1 ms, or 4 ms)	100 μs, 1 ms, or 4 ms	200 μs (high-speed models: 20 μs)
Light source	Red, green, blue, or infrared LED		Red or green LED
Function	Dual display (including digital, bar, percent, and hold display functions) Threshold adjustment performed manually or by teaching OFF-delay, ON-delay, one-shot timer (adjustable from 1 ms to 5 s)		LED bar display (5 levels) 8-turn sensitivity adjuster OFF delay timer (fixed at 40 ms)
	Advanced-function models are available (2-output/input models).		Water-resistant models are available.
Models	E3X-DA□-S E3X-DA□TW-S (2-output model) E3X-DA□RM-S (input model)	E3X-MDA□	E3X-NA□ E3X-NA□F (high-speed model) E3X-NA□V (water-resistant model)

---

■ Selection Guide .....	P4
-------------------------	----

---

■ Overview of Features, Applications, and Variations	
Standard Models	Flexible (New Standard) ..... P6
	Standard ..... P6
	Break-resistant ..... P6
	Fluorine Coating ..... P7
Special-beam Models	Long Distance, High Power ..... P10
	Ultracompact, Ultrafine Sleeve ..... P10
	Coaxial, Small Spot ..... P11
	Fine Beam (Narrow Vision Field) ..... P12
	Area Sensing ..... P12
	Retroreflective ..... P13
	Limited-reflective ..... P13
Environment-resistive Models	Heat-resistant ..... P14
	Chemical-resistant ..... P14
	Vacuum-resistant ..... P15
Application-corresponding Models	Label Detection ..... P16
	Liquid-level Detection ..... P16
	Glass-substrate Alignment ..... P17
	Glass-substrate Mapping ..... P17
	Water Mapping ..... P18

---

■ Ordering Information	
Through-beam Fiber Units .....	P19
Fiber Units with Reflective Sensors .....	P26
Application-corresponding Fiber Units .....	P33

---

■ Ratings/Characteristics.....	P37
--------------------------------	-----

---

■ Dimensions	
Through-beam Fiber Units .....	P40
Fiber Units with Reflective Sensors .....	P48
Application-corresponding Fiber Units .....	P57

---

■ Precautions.....	P63
--------------------	-----

Features/Applications

Standard Models

Flexible (New Standard)

R

- Perform wiring without worrying about the bending radius.
- Choose the model to suit the installation space from a variety of shapes.

Flexible fiber

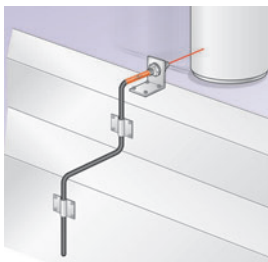

Conventional fiber

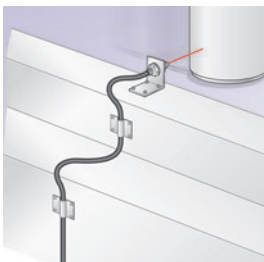

Fewer problems

Light intensity affected by bends in fiber  
Fiber broken by getting caught on surrounding objects

Feature: Multicore (Flexible) Fibers



A large number of ultrafine cores are all surrounded by cladding. As a result, the fiber is flexible and can be bent without significantly reducing the light intensity. This helps solve problems, such as fiber being broken by getting caught on other objects.

Ratings/Characteristics

Min. sensing object	0.005-mm dia.
Min. bending radius	1 mm
Ambient temperature range	-40°C to 70°C (no icing or condensation)
Fiber material	Plastic (Free-cut)

Standard

- Choose the model to suit the installation space from a variety of shapes.
- New flat models allow space savings and simple installation.



Screw-shaped

Cylindrical

Flat

Equipped with sleeve

Feature: Flat Models

Flat models, which allow simple attachment and wiring, have been added to the lineup. Choose the model to suit the installation space from 3 sensing directions and 2 sizes, standard and small.



Ratings/Characteristics

Min. sensing object	0.005-mm dia.
Min. bending radius	10 or 25 mm*
Ambient temperature range	-40°C to 70°C (no icing or condensation)
Fiber material	Plastic (Free-cut)

\*Depends on the fiber diameter.

Break-resistant

B

- Bundle-fiber models can be used for moving parts.
- Capable of withstanding at least one million repeated bends (in typical applications).



Feature: Bundle Fibers

The Fiber Units contain a large number of independent fine fibers, ensuring a high degree of flexibility.



Ratings/Characteristics

Min. sensing object	0.005-mm dia.
Min. bending radius	4 mm (withstands repeated bending)
Ambient temperature range	-40°C to 70°C (no icing or condensation)
Fiber material	Plastic (Free-cut)

Standard Models

Fluorine Coating



- Fiber degradation due to oil is prevented using a fluororesin coating.
- Free cutting is possible with cutter provided.

Oil is blocked!

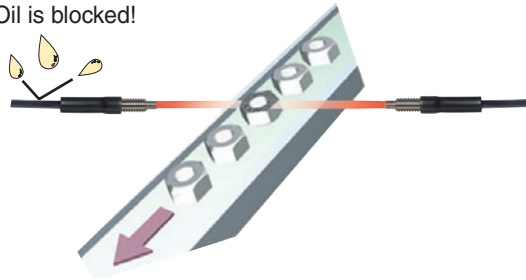

■ Feature: Fluorine Coating

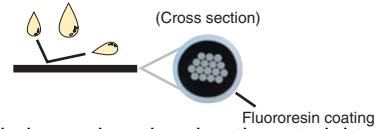

Fluororesin is used as the sheath material to prevent fiber degradation resulting from oil adhesion.

Note: The tip of the head is not chemical-resistant.

■ Ratings/Characteristics

Min. sensing object	0.005-mm dia.
Min. bending radius	4 mm
Ambient temperature range	-40°C to 70°C (with no icing or condensation)
Fiber material	Plastic (Free-cut)

Fiber Customization Service (Fiber Length, Sleeve Length, and Bends)

Fiber Length



- Applicable Models
  - Standard models
  - Flexible Break-resistant Models

- Model Number Used for Ordering
  - Standard model number + Fiber length
  - Fiber length: 0.3 m, 0.5 m, or any length from 1 to 20 m (in 1-m units)

Sleeve Length and Bends

- Applicable Models
  - E32-TC200B/E32-TC200F
  - E32-DC200B/E32-DC200F
  - The E32-DC200B cannot be bent.

This customization/delivery service applies to standard models. It is aimed at reducing industrial waste and simplifying the installation procedure.

■ Fiber Length vs. Sensing Distance Through-beam Fiber Units

(Fiber length of 2 m corresponds to 100%.)

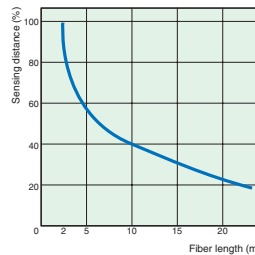

■ Fiber Units with Reflective Sensors (Fiber length of 2 m corresponds to 100%.)

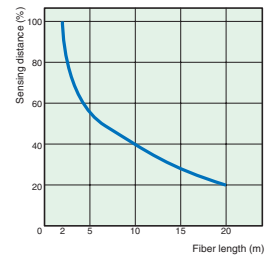

■ Model Number Used When Changing Only the Sleeve Length



Model: E32-<sup>\*1</sup>C200<sup>\*2</sup>-S<sup>\*3</sup>

■ Model Number Used When Changing the Sleeve Length and Bends

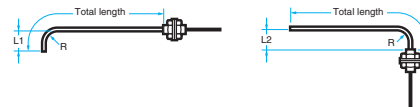

Model Numbers Incorporating the Bending Radius, R, and Dimensions L1 and L2  
 Specifying L1 Only (Units: mm)      Specifying L2 Only (Units: mm)

Bending radius	Specifying L1 Only (Units: mm)		Specifying L2 Only (Units: mm)	
	L1 (±1)	Model number	L2 (±1)	Model number
R5	10	E32- <sup>*1</sup> C200 <sup>*2</sup> -S <sup>*3</sup> A1	5	E32- <sup>*1</sup> C200 <sup>*2</sup> -S <sup>*3</sup> A3
	15	E32- <sup>*1</sup> C200 <sup>*2</sup> -S <sup>*3</sup> A2	10	E32- <sup>*1</sup> C200 <sup>*2</sup> -S <sup>*3</sup> A4
R7.5	12.5	E32- <sup>*1</sup> C200 <sup>*2</sup> -S <sup>*3</sup> B1	7.5	E32- <sup>*1</sup> C200 <sup>*2</sup> -S <sup>*3</sup> B3
	17.5	E32- <sup>*1</sup> C200 <sup>*2</sup> -S <sup>*3</sup> B2	17.5	E32- <sup>*1</sup> C200 <sup>*2</sup> -S <sup>*3</sup> B4
R10	15	E32- <sup>*1</sup> C200 <sup>*2</sup> -S <sup>*3</sup> C1	10	E32- <sup>*1</sup> C200 <sup>*2</sup> -S <sup>*3</sup> C3
	20	E32- <sup>*1</sup> C200 <sup>*2</sup> -S <sup>*3</sup> C2	20	E32- <sup>*1</sup> C200 <sup>*2</sup> -S <sup>*3</sup> C4
R12.5	17.5	E32- <sup>*1</sup> C200 <sup>*2</sup> -S <sup>*3</sup> D1	12.5	E32- <sup>*1</sup> C200 <sup>*2</sup> -S <sup>*3</sup> D3
	22.5	E32- <sup>*1</sup> C200 <sup>*2</sup> -S <sup>*3</sup> D2	22.5	E32- <sup>*1</sup> C200 <sup>*2</sup> -S <sup>*3</sup> D4

\*1: Insert "T" for Through-beam Fiber Units and "D" for Fiber Units with Reflective Sensors.  
 \*2: Insert the "B" or "F" that appears at the end of the original model number.  
 \*3: Insert "50" if the total length is 50 mm. The total length must not exceed 120 mm.









Features/Applications

Standard Models

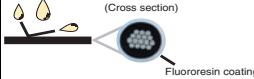
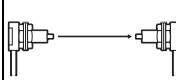

Overview of Model Variations

Sensing distance (mm) (See note 1.)
Model

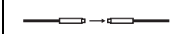
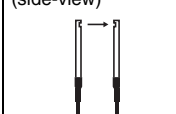
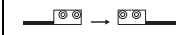
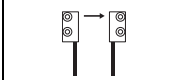
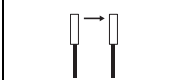
Through-beam Fiber Units

Type (See note 2.)	Flexible (New Standard)  Flexible and pliable 	Standard 	Break-resistant  Withstands repeated bending 	Fluorine coating  (Cross section) Fluororesin coating Cable protected against oil 
	M4 530 E32-T11N			
	M4 530 E32-T11R	760 E32-TC200	680 E32-T11	680 E32-T11U
	M3 130 E32-T21R	220 E32-TC200E	200 E32-T21	
	M4 (1.2-dia. sleeve) 530 E32-TC200BR	760 E32-TC200B		
	M3 (0.9-dia. sleeve) 130 E32-TC200FR	220 E32-TC200F		
	Cylindrical (top-view) 	3 dia. 530 E32-T12R	760 E32-T12	680 E32-T12B
1.5 dia. 130 E32-T222R		220 E32-T222	200 E32-T22B	
(side-view) 	3 dia. 210 E32-T14LR	460 E32-T14L		
	1 dia. 50 E32-T24R	130 E32-T24		
Flat (top-view) 	15 x 8 x 3 530 E32-T15XR	760 E32-T15X	680 E32-T15XB	
	12 x 7 x 2 130 E32-T25XR	220 E32-T25X	150 E32-T25XB	
(side-view) 	15 x 8 x 3 210 E32-T15YR	460 E32-T15Y		
	12 x 7 x 2 50 E32-T25YR	130 E32-T25Y		
(flat-view) 	15 x 8 x 3 210 E32-T15ZR	460 E32-T15Z		
	12 x 7 x 2 50 E32-T25ZR	130 E32-T25Z		

Note 1. The sensing distances apply for use in combination with the E3X-DA-S Amplifier Unit (general-purpose, standard mode).

2. These symbols are defined as follows.  : Flexible fiber,  : Bendable fiber,  : Fluorine-coated fiber.















Standard Models

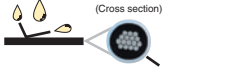

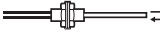
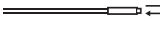
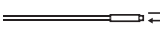
Overview of Model Variations

Sensing distance (mm) (See note 1)
Model

Fiber Units with Reflective Sensors

Shape of head [For dimensions, refer to page 40.]	Type (See note 2.)	Flexible (New Standard)   Flexible and pliable	Standard 	Break-resistant   Withstands repeated bending	Fluorine coating  (Cross section)  Cable protected against oil
	M6	170			
	E32-D11N				
	M6	170			
	E32-C11N				
	M3	25			
	E32-C31N				
Screw-shaped (top-view) 	M6	170	300	170	170
	E32-D11R		E32-DC200	E32-D11	E32-D11U
	M3	30	80	30	
	E32-D21R		E32-DC200E	E32-D21	
(with sleeve) 	M6 (2.5-dia. sleeve)	170	300		
	E32-DC200BR		E32-DC200B		
	M3 (1.2-dia. sleeve)	30	80		
	E32-DC200FR		E32-DC200F		
Cylindrical (top-view) 	3 dia.	170	230	70	
	E32-D12R		E32-D12	E32-D221B	
	3 dia. (1.5 dia.)	30	80	30	
	E32-D22R		E32-D22	E32-D22B	
(side-view) 	6 dia.	45	110		
	E32-D14LR		E32-D14L		
	2 dia.	15	30		
	E32-D24R		E32-D24		
Flat (top-view) 	15 × 10 × 3	170	300	170	
	E32-D15XR		E32-D15X	E32-D15XB	
	12 × 7 × 2	30	80	50	
	E32-D25X		E32-D25X	E32-D25XB	
(side-view) 	15 × 10 × 3	40	100		
	E32-D15YR		E32-D15Y		
	12 × 8 × 2	8	20		
	E32-D25YR		E32-D25Y		
(flat-view) 	15 × 10 × 3	40	100		
	E32-D15ZR		E32-D15Z		
	12 × 8 × 2	8	20		
	E32-D25ZR		E32-D25Z		

Note 1. The sensing distances apply for use in combination with the E3X-DA-S Amplifier Unit (general-purpose, standard mode).

2. These symbols are defined as follows.  : Flexible fiber,  : Bendable fiber,  : Fluorine-coated fiber.

## Features/Applications

### Special-beam Models

#### Long Distance, High Power

- Powerful beam reduces influence of dust and dirt.
- Long sensing distance enables use in large-scale installations.

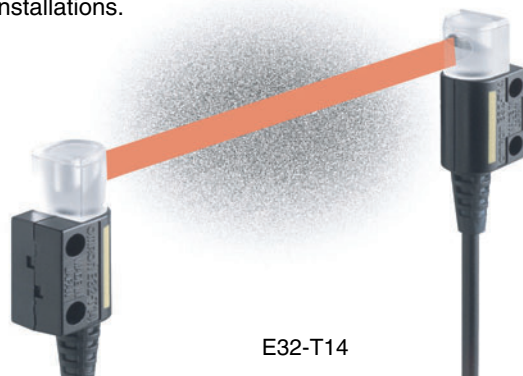

#### Applications

Detecting parts inside (translucent) containers



Detecting workpieces in coating processes



#### Ratings/Characteristics

Ambient temperature range	-40°C to 70°C (no icing or condensation)
Fiber material	Plastic (Free-cut)

#### Overview of Model Variations

Type	Features	Shape, sensing distance (mm)*	Model number
Through-beam	Equipped with large lens	20,000	E32-T17L
	Side-view, screw mounting	3,400	E32-T14
	M4 screw	1,330	E32-T11L
Reflective	Equipped with large lens	700	E32-D16
	M6 screw	400	E32-D11L

#### Ultracompact, Ultrafine Sleeve

- Ultracompact head can be installed in tight spaces.
- Ultrafine sleeve ensures reliable detection of small objects, such as electronic components.



#### Applications

Alignment inspections

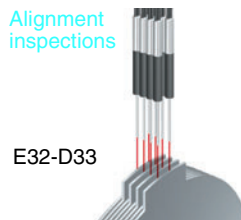

Detection of terminals



#### Ratings/Characteristics

Min. sensing object	0.005-mm dia.
Ambient temperature range	-40°C to 70°C (no icing or condensation)
Material	Plastic

#### Overview of Model Variations

Type	Features	Shape, sensing distance (mm)*	Model number
Through-beam	1-dia. cylinder	130	E32-T223R
	0.5-dia. sleeve (0.25-dia. opening)	44	E32-T33-S5
	0.22-dia. sleeve (0.1-dia. opening)	5	E32-T334-S5
Reflective	0.8-dia. sleeve	16	E32-D33
	0.5-dia. sleeve	3	E32-D331

\*The sensing distances apply for use in combination with the E3X-DA-S Amplifier Unit (general-purpose, standard mode).

Special-beam Models

Coaxial, Small Spot

- Small spot diameter (0.1 mm min. in diameter) enables the reliable detection of small workpieces.
- Use of red light ensures easy visual recognition and simple positioning.

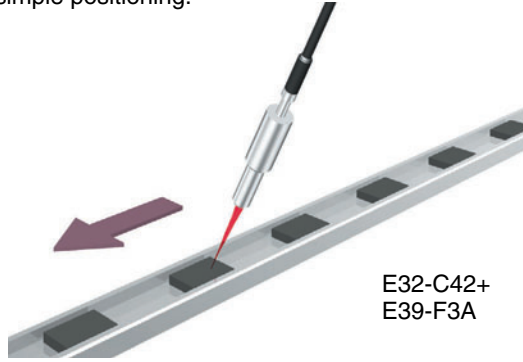

Applications

Detecting of CDs

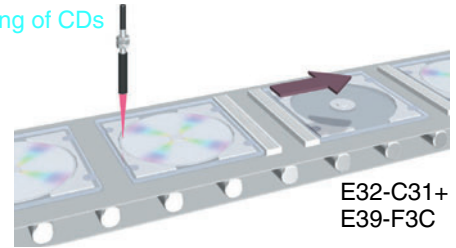

Ratings/Characteristics

Min. sensing object	0.005-mm dia.
Ambient temperature range	-40°C to 70°C (no icing or condensation)
Fiber material	Plastic

Overview of Model Variations

Type	Features	Shape, sensing distance (mm)*	Model number
Coaxial, reflective	Coaxial, M6 screw	300	E32-CC200
	Coaxial, 3-dia. cylinder	150	E32-D32L
	Small spot	0.1-dia. spot at a distance of 7 mm	E32-C41+ E39-F3A-5
	Small variable spot	Spot diameter variable in the range 0.1 to 0.6 mm at distances in the range 6 to 15 mm	E32-C42+ E39-F3A
	Long distance, small spot	0.5-dia. spot at 17 mm	E32-C31+ E39-F3B
	Long distance, parallel light	Spot diameter of 4 mm max. at distances in the range 0 to 20 mm	E32-C31+ E39-F3C

\*The sensing distances apply for use in combination with the E3X-DA-S Amplifier Unit (general-purpose, standard mode).

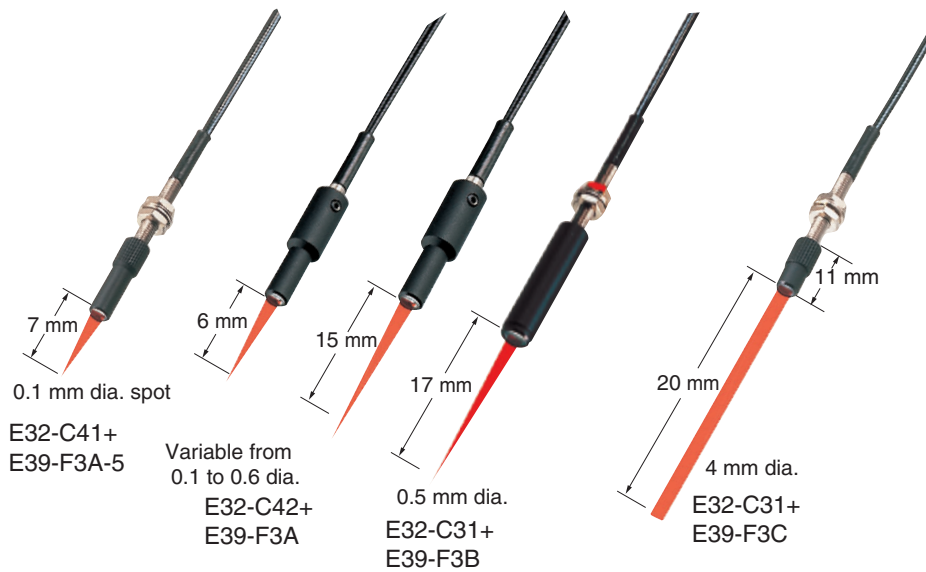

Features/Applications

Special-beam Models

Fine Beam (Narrow Vision Field)

- Fine beam reduces unwanted light in surrounding area.
- Powerful beam allows use in applications requiring a long sensing distance.

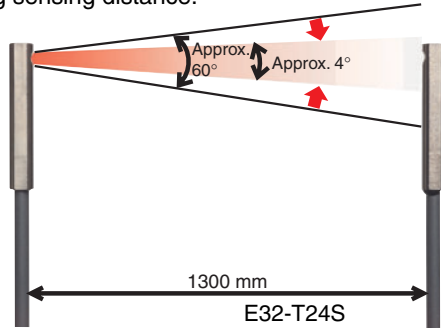

Applications

Alignment inspection of orientation flats

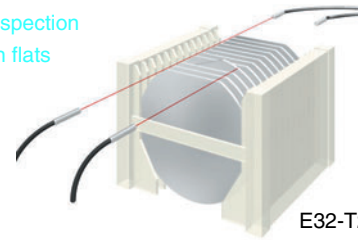

E32-T22S

Ratings/Characteristics

Min. bending radius	10 mm
Ambient temperature range	-40°C to 70°C (no icing or condensation)
Fiber material	Plastic (Free-cut)

Overview of Model Variations

Type	Features	Shape, sensing distance (mm)*	Model number
Through-beam	Top view	1,900	E32-T22S
	Side view	1,300	E32-T24S

\*The sensing distances apply for use in combination with the E3X-DA-S Amplifier Unit (general-purpose, standard mode).

Area Sensing

- These Fiber Units ensure greater reliability with the detection of position inconsistencies in passing workpieces and the presence of workpieces with holes.
- Wide sensing bands of 11 and 30 mm (through-beam models) enable the detection of large position inconsistencies.

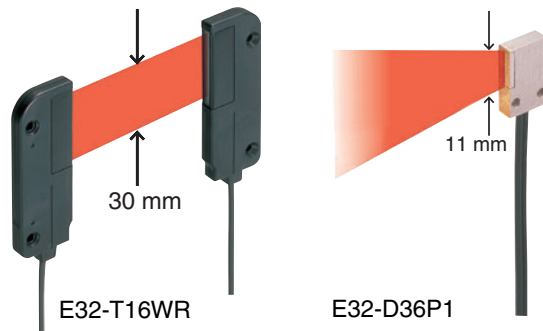

Applications

Detecting passage of candies

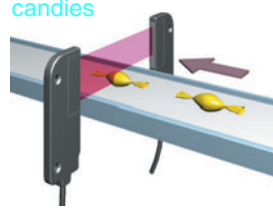

E32-T16WR

Detecting chips on film

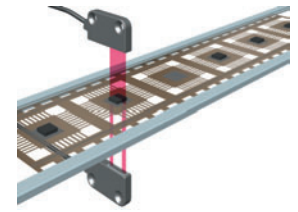

E32-T16PR

Ratings/Characteristics

Ambient temperature range	-40°C to 70°C (no icing or condensation) E32-T16W□ only: -25°C to 55°C
Fiber material	Plastic (Free-cut)

Overview of Model Variations

Type	Features	Shape, sensing distance (mm)*	Model number
Through-beam	Sensing width: 11 mm	840	E32-T16PR
	Sensing width: 11 mm Flat-view	750	E32-T16JR
	Sensing width: 30 mm	1,300	E32-T16WR
Reflective	Beam width: 11 mm	150	E32-D36P1

\*The sensing distances apply for use in combination with the E3X-DA-S Amplifier Unit (general-purpose, standard mode).

Special-beam Models

Retroreflective

- The return optical path ensures that more light is interrupted by transparent workpieces than with through-beam models.
- Equipped with MSR function to eliminate light reflected directly from the workpiece.

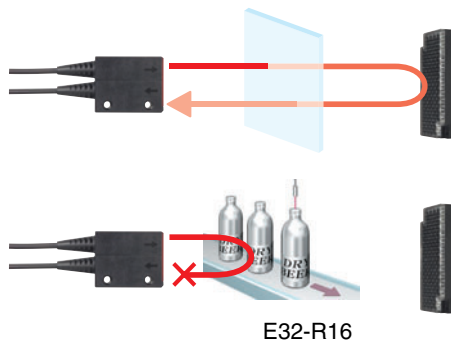

E32-R16

Applications

Detecting translucent medicine

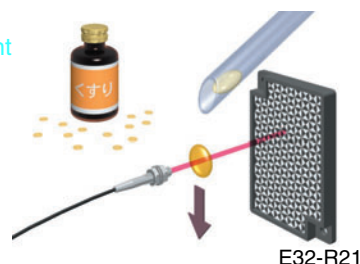

E32-R21

Ratings/Characteristics

Ambient temperature range	E32-R21: -40°C to 70°C E32-R16: -25°C to 55°C (with no icing or condensation)
Fiber material	Plastic <span style="border: 1px solid black; border-radius: 50%; padding: 2px;">Free-cut</span>

Overview of Model Variations

Type	Features	Shape, sensing distance (mm)*	Model number
Retro-reflective	MSR function, M6 screw	250	E32-R21
	MSR function, screw mounting, long distance	1,500	E32-R16

\*The sensing distances apply for use in combination with the E3X-DA-S Amplifier Unit (general-purpose, standard mode).

Limited-reflective

- Limited-reflective models eliminate light reflected from distant objects.
- Small level differences can be reliably detected.
- The optical-axis direction can be selected according to the installation space.

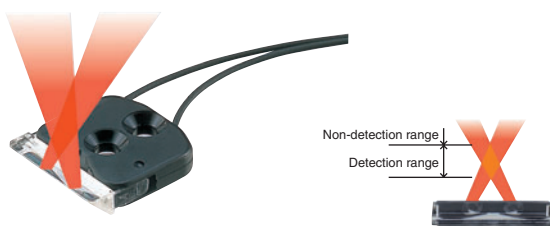

E32-L24L

Applications

Detecting connector pins

Detecting wafers (glass substrates)

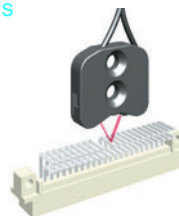

E32-L25L

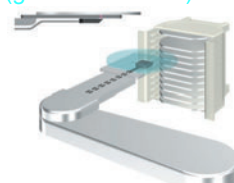

E32-L24L

Ratings/Characteristics

Min. sensing object	0.005-mm dia.
Fiber material	Plastic <span style="border: 1px solid black; border-radius: 50%; padding: 2px;">Free-cut</span> 200°C models only: Glass

Overview of Model Variations

Type	Features	Shape, sensing distance (mm)*	Model number
Limited-reflective	Ultracompact, flat-view Ideal for checking stocks of glass substrates	0 to 4	E32-L24S
	Heat-resistant up to 105°C, top-view	5.4 to 9 (center: 7.2)	E32-L25L
	Wide sensing range, flat-view	0 to 15	E32-A10
	Heat-resistant up to 200°C, flat-view	4 to 10	E32-L86

\*The sensing distances apply for use in combination with the E3X-DA-S Amplifier Unit (general-purpose, standard mode).

## Features/Applications

### Environment-resistant Models

#### Heat-resistant

- These Fiber Units can be used for various applications in temperatures up to 400°C.

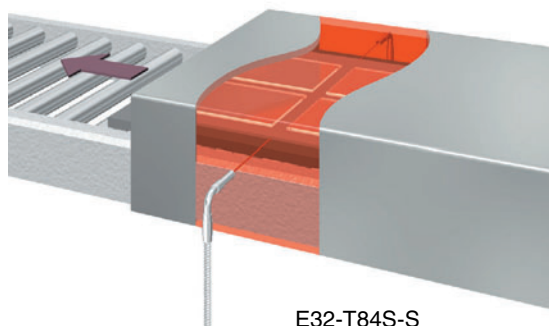

#### Applications

Detecting wafers in high-temperature environments

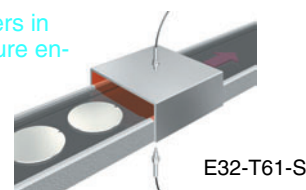

#### Ratings/Characteristics

	150°C models	200°C and higher models	
		E32-T81R E32-D81R	All other models
Min. bending radius	35 mm	10 mm	25 mm
Fiber material	Plastic (fluororesin coating) <small>Free-cut</small>	Glass (fluororesin coating)	Glass (SUS spiral coating)

#### Overview of Model Variations

Type	Ambient temperature range	Features	Shape, sensing distance (mm) <sup>*1</sup>	Model number
Through-beam	-40°C to 150°C	M4 screw	760	E32-T51
	-40°C to 200°C	L-shaped, long distance	1,300	E32-T84S-S
	-60°C to 350°C	M4 screw	450	E32-T61-S
Reflective <sup>*2</sup>	-60°C to 350°C	M6 screw	90	E32-D61-S
	-40°C to 400°C	M6 screw, with sleeve	60	E32-D73-S

<sup>\*1</sup> The sensing distances apply for use in combination with the E3X-DA-S Amplifier Unit (general-purpose, standard mode).

<sup>\*2</sup> Order the Fiber Unit based on the Amplifier Unit. Use the E32-D□-S if the E3X-DA□-S, E3X-MDA□, or E3X-DAC□-S is used. Use the E32-D□ if any other Amplifier is used.

#### Chemical-resistant

- Built-in lens and high-power beam reduce the influence of dirt and drops of water.
- Round design prevents drops of water sticking to the head (E32-T11F).

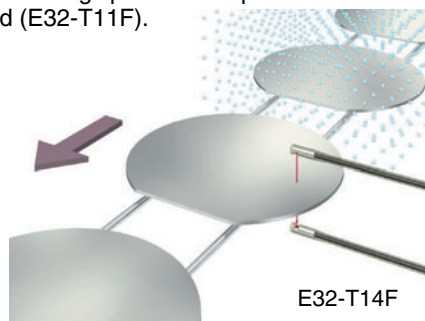

#### Applications

Detecting workpieces in cleaning processes

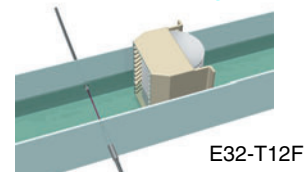

#### Ratings/Characteristics

	All other models	E32-T51F	E32-T81F-S
	Ambient temperature range	-40°C to 70°C	-40°C to 150°C
Fiber material	Plastic (fluororesin coating) <small>Free-cut</small>		Glass (fluororesin coating)

#### Overview of Model Variations

Type	Features	Shape, sensing distance (mm) <sup>*</sup>	Model number
Through-beam	Water-resistant round head	2,000	E32-T11F
	Built-in lens, high power	3,000	E32-T12F
	Heat-resistant up to 200°C	700	E32-T81F-S
Reflective <sup>*2</sup>	Built-in lens, high power	95	E32-D12F

<sup>\*</sup>The sensing distances apply for use in combination with the E3X-DA-S Amplifier Unit (general-purpose, standard mode).

Environment-resistant Models

Vacuum-resistant

- These models can be used in high-vacuum environments at pressures from  $10^{-5}$  to 0.1 Pa.
- The 4-channel multi-flange, which has a maximum leakage rate of  $1 \times 10^{-10}$  Pa·m<sup>3</sup>/s, contributes to space savings.



Applications (Configuration Example)

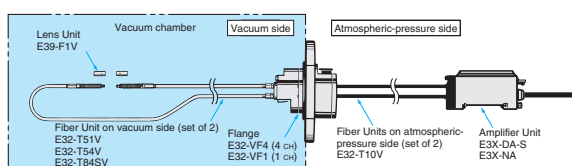

Ratings/Characteristics

	120°C models	200°C models	Atmospheric-pressure side
Min. bending radius	30 mm	25 mm	
Fiber material	Glass (fluororesin coating)	Glass (SUS spiral coating)	Plastic <span style="border: 1px solid black; border-radius: 50%; padding: 2px;">Free-cut</span>

Overview of Model Variations

Type	Features	Shape, sensing distance (mm)*	Model number
Through-beam	M4 screw, top-view, heat-resistant up to 120°C, long distance	1,000	E32-T51V+ E39-F1V
	L-shaped, heat-resistant up to 120°C	130	E32-T54V 1M
	L-shaped, long distance, heat-resistant up to 200°C	480	E32-T84SV 1M

\*The sensing distances apply for use in combination with the E3X-DA-S Amplifier Unit (general-purpose, standard mode).

Fiber Units on Atmospheric-pressure Side

Appearance	Type	Model number
	Common	E32-T10V 2M

Flanges

Appearance	Type	Model number
	4-channel flange	E32-VF4
	1-channel flange	E32-VF1

Ratings/Characteristics

Item	Number of channels	4 channels	1 channels
	Model	E32-VF4	E32-VF1
Leakage rate	$1 \times 10^{-10}$ Pa·m <sup>3</sup> /s max.		
Ambient temperature range	Operating: -25°C to 55°C Storage: -25°C to 55°C		
Material	Aluminum (A5056)		Stainless steel (SUS304) Aluminum (A5056)
Flange-seal material	Fluorocarbon rubber (Viton)		
Weight (packed state)	Approx. 280 g		Approx. 240 g

## Features/Application

### Application-corresponding Models

#### Label Detection

- Built-in lens and high-power beam enable the reliable detection of labels through a mounting board.
- These Fiber Units can be washed with hydrogen peroxide, making them ideal for the food industry.



#### Applications

##### Detecting labels

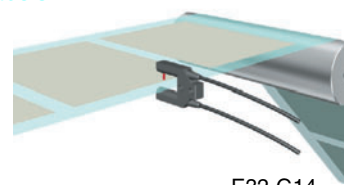

E32-G14

#### Ratings/Characteristics

Ambient temperature range	-40°C to 70°C (no icing or condensation)
Fiber material	Plastic (Free-cut)
Degree of protection	IP67

#### Overview of Model Variations

Type	Features	Shape, sensing distance (mm)*	Model number
Through-beam	Slot sensor, no adjustment of optical axis required	10	E32-G14
	Screw mounting, side-view	3,400	E32-T14

\*The sensing distances apply for use in combination with the E3X-DA-S Amplifier Unit (general-purpose, standard mode).

#### Liquid-level Detection

- Area sensing is possible with minimal influence from bubbles and drops of water (E32-A01/A02/D36T).
- For safety when disconnections occur, two models have been developed, a light ON model for liquid presence and a light ON model for liquid absence (E32-A01/A02).

##### Tube-mounting model



E32-D36T

##### Liquid-contact model

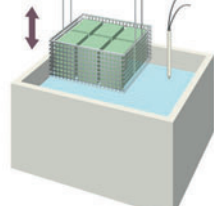

E32-D82F1

#### Operating Principle

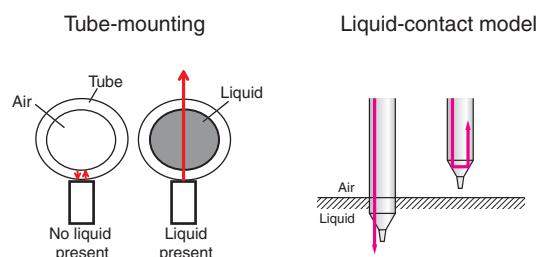

The presence/absence of liquid is detected using the refractive properties of light. More specifically, it utilizes the fact that the difference in refractive index between the air and the tip/tube is larger than the difference between the liquid and the tip/tube.

#### Overview of Model Variations

Type	Features	Shape, sensing distance (mm)*	Model number
Tube-mounting	Light ON when liquid is present (ideal for checking lower limits)	Applicable tube: Transparent tube with a diameter of 3.2, 6.4, or 9.5 mm and a recommended wall thickness of 1 mm	E32-A01
	Light ON when liquid is absent (ideal for checking for overflow)	Applicable tube: Transparent tube with a diameter in the range 6 to 13 mm and a recommended wall thickness of 1 mm	E32-A02
	No restriction on tube diameter, resistant to bubbles and drops of water	Applicable tube: Transparent tube (no restriction on diameter)	E32-D36T
Liquid-contact	Heat-resistant up to 200°C, shape prevents liquid buildup	Liquid-contact model	E32-D82F1

\*The sensing distances apply for use in combination with the E3X-DA-S Amplifier Unit (general-purpose, standard mode).



Application-corresponding Models

Glass-substrate Alignment

- There is little variation of detection position within the detection range ( $\pm 0.1$  mm max.)
- The different model variations can handle a variety of sensing distances and temperature conditions.

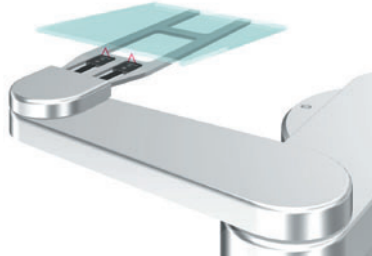

E32-L16-N

Engineering Data (E32-A07/A08/L16-N)

Detection-Position Characteristic (Typical Examples)

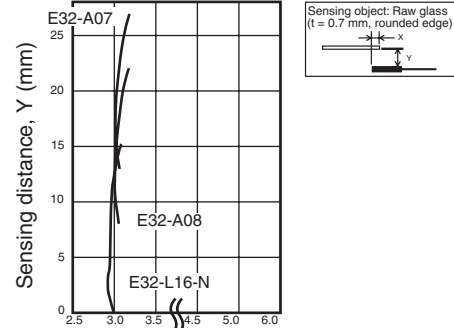

Overview of Model Variations

Type	Features	Shape, sensing distance (mm)*	Model number
Limited-reflective	0 to 15 mm, wide-range sensing	0 to 15	E32-L16-N
	Long-distance sensing	10 to 20	E32-A08
		15 to 25	E32-A07E1 E32-A07E2
	Heat-resistant up to 300°C	5 to 18	E32-L66

\*The sensing distances apply for use in combination with the E3X-DA-S Amplifier Unit (general-purpose, standard mode).

Glass-substrate Mapping

- These models can reliably detect thin glass-substrate end faces ( $t = 0.5$  mm, beveled edge).
- Using a large-diameter lens makes it possible to cope with tilting of the glass substrates.

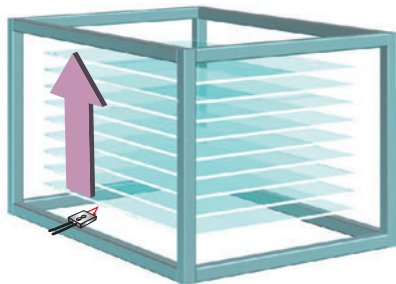

E32-A09

Engineering Data (E32-A09)

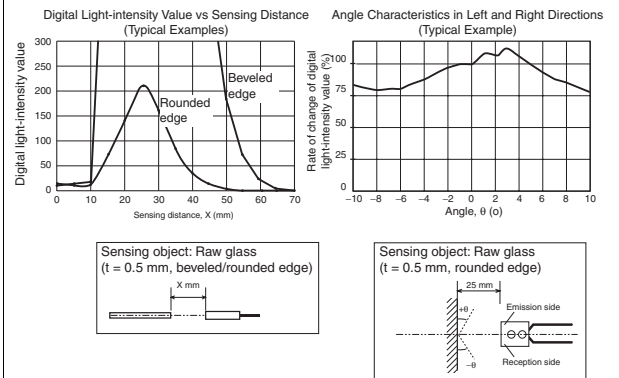

Overview of Model Variations

Type	Features	Shape, sensing distance (mm)*	Model number
Limited-reflective	Large-diameter lens ensures resistance to tilting	15 to 38 (center: 25)	E32-A09
	Heat-resistant up to 150°C		E32-A09H
	Heat-resistant up to 300°C	20 to 30 (center: 25)	E32-A09H2

\*The sensing distances apply for use in combination with the E3X-DA-S Amplifier Unit (general-purpose, standard mode).

Features/Applications

Application-corresponding Models

Wafer Mapping

- Wafers are reliably detected with an ultrafine beam.
- The optical axis is adjusted before delivery to allow easy installation.

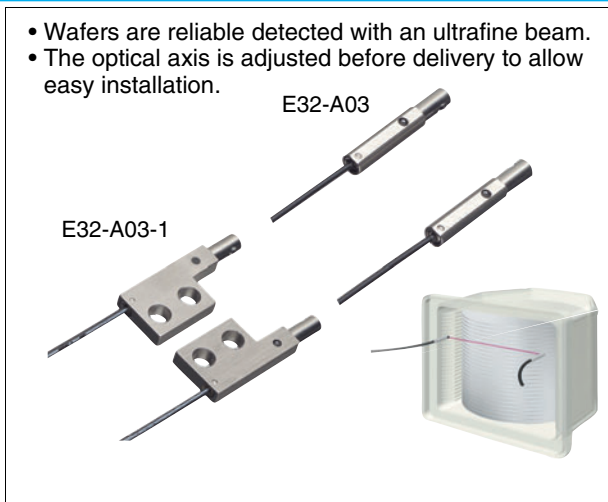

■ Features

Optical axis adjusted before delivery so that displacement is typically within 0.1°.

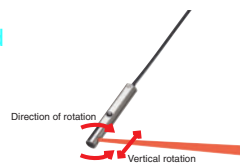

■ Engineering Data

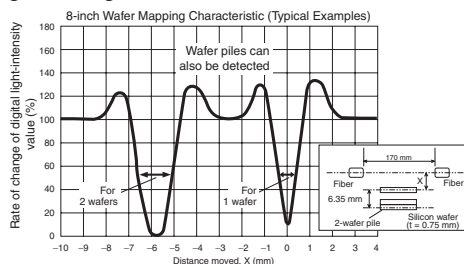

■ Overview of Model Variations







Type	Features	Shape, sensing distance (mm)*	Model number
Through-beam	Opening angle: 1.5°		E32-A03
	With mounting flange		E32-A03-1
	Opening angle: 3° ultraslim		E32-A04
	With mounting flange		E32-A04-1

\*The sensing distances apply for use in combination with the E3X-DA-S Amplifier Unit (general-purpose, standard mode).

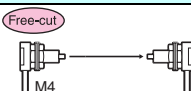
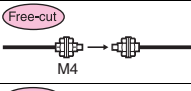
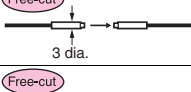
Ordering Information

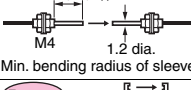
Through-beam Fiber Units **Standard models**

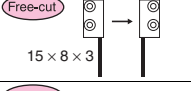
High-resolution mode 
  Standard mode 
  High-speed mode 
  Super-high-speed mode 
 \*When used in combination with the E3X-DA-S Amplifier Unit (general-purpose).

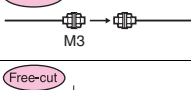
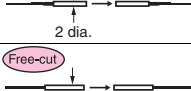
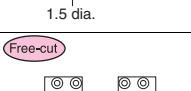
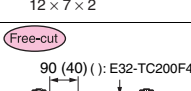
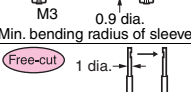
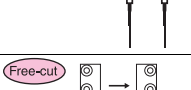
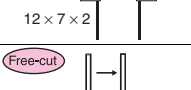
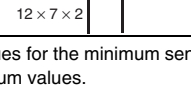
Type	Appearance (mm) *2	Dimensions page	Sensing distance (mm)			Standard object (min. sensing object) (mm) *1	Min. bending radius (mm)	Features	Model number		
Flexible (new standard)	Standard size		40				1 dia. (0.005 dia.)	M4 right angle	E32-T11N		
			40					M4 screw	E32-T11R		
			40	<span style="background-color: #FF0000; width: 100%; height: 10px;"></span> 700	<span style="background-color: #FF6666; width: 100%; height: 10px;"></span> 530	<span style="background-color: #FF9999; width: 100%; height: 10px;"></span> 350 (140)		3-dia. cylinder	E32-T12R		
			40					Flat shape	E32-T15XR		
			40	90 (40) ( ): E32-TC200B4R M4 1.2 dia. Min. bending radius of sleeve: 5					M4 screw, with sleeve	E32-TC200BR E32-TC200B4R	
			40					3-dia. cylinder, side-view	E32-T14LR		
			41	15 x 8 x 3	<span style="background-color: #FF0000; width: 100%; height: 10px;"></span> 270	<span style="background-color: #FF6666; width: 100%; height: 10px;"></span> 210		<span style="background-color: #FF9999; width: 100%; height: 10px;"></span> 130 (50)	Flat shape, side-view	E32-T15YR	
		41	15 x 8 x 3					Flat shape, flat-view	E32-T15ZR		
	Small size		40					0.5 dia. (0.005 dia.)	M3 screw (small)	E32-T21R	
			40						2-dia. cylinder (small)	E32-T22R	
			40		<span style="background-color: #FF0000; width: 100%; height: 10px;"></span> 160	<span style="background-color: #FF6666; width: 100%; height: 10px;"></span> 130			<span style="background-color: #FF9999; width: 100%; height: 10px;"></span> 75 (30)	1.5-dia. cylinder (small)	E32-T222R
			40	12 x 7 x 2						Flat shape (small)	E32-T25XR
			40	90 (40) ( ): E32-TC200F4R M3 0.9 dia. Min. bending radius of sleeve: 5						M3 screw (small), with sleeve	E32-TC200FR E32-TC200F4R
			41							1-dia. cylinder (small), side-view	E32-T24R
		41	12 x 7 x 2	<span style="background-color: #FF0000; width: 100%; height: 10px;"></span> 60	<span style="background-color: #FF6666; width: 100%; height: 10px;"></span> 50	<span style="background-color: #FF9999; width: 100%; height: 10px;"></span> 25 (10)	Flat shape (small), side-view		E32-T25YR		
	41	12 x 7 x 2				Flat shape (small), flat-view	E32-T25ZR				









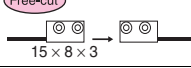
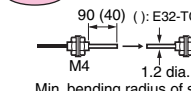

\*1. The values for the minimum sensing object are representative values that indicate values obtained in standard mode with the sensing distance and sensitivity set to optimum values.

\*2.  Indicates models that allow free cutting.

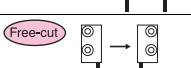
R Flexible 
 B Break-resistant 
 U Fluororesin coating

Through-beam Fiber Units **Standard models**

High-resolution mode 
  Standard mode 
  High-speed mode 
  Super-high-speed mode 
 \*When used in combination with the E3X-DA-S Amplifier Unit (general-purpose).

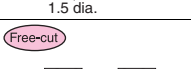
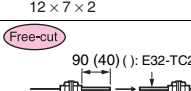
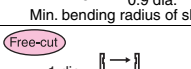
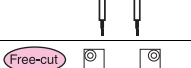
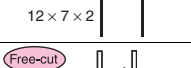
Type	Appearance (mm) *2	Dimensions page	Sensing distance (mm)			Standard object (min. sensing object) (mm) *1	Min. bending radius (mm)	Features	Model number	
Standard	Standard size		40				1 dia. (0.005 dia.)	R25	M4 screw	E32-TC200
			40						3-dia. cylinder	E32-T12
			40	<span style="display:inline-block; width:100px; height:10px; background-color:blue;"></span> 1,000	<span style="display:inline-block; width:100px; height:10px; background-color:orange;"></span> 760	<span style="display:inline-block; width:100px; height:10px; background-color:yellow;"></span> 500 (200)			Flat shape	E32-T15X
			40						M4 screw, with sleeve	E32-TC200B E32-TC200B4
			40						3-dia. cylinder, side-view	E32-T14L
			41	<span style="display:inline-block; width:100px; height:10px; background-color:blue;"></span> 600	<span style="display:inline-block; width:100px; height:10px; background-color:orange;"></span> 460	<span style="display:inline-block; width:100px; height:10px; background-color:yellow;"></span> 300 (120)			Flat shape, side-view	E32-T15Y
			41						Flat shape, flat-view	E32-T15Z
			40	<span style="display:inline-block; width:100px; height:10px; background-color:blue;"></span> 900	<span style="display:inline-block; width:100px; height:10px; background-color:orange;"></span> 680	<span style="display:inline-block; width:100px; height:10px; background-color:yellow;"></span> 450 (180)			M3 screw (small)	E32-TC200A
			40							E32-TC200E
			40						2-dia. cylinder (small)	E32-T22
		40	<span style="display:inline-block; width:100px; height:10px; background-color:blue;"></span> 270	<span style="display:inline-block; width:100px; height:10px; background-color:orange;"></span> 220	<span style="display:inline-block; width:100px; height:10px; background-color:yellow;"></span> 125 (50)	1.5-dia. cylinder (small)	E32-T222			
		40				Flat shape (small)	E32-T25X			
		40				M3 screw (small), with sleeve	E32-TC200F E32-TC200F4			
		41				1-dia. cylinder (small), side-view	E32-T24			
		41	<span style="display:inline-block; width:100px; height:10px; background-color:blue;"></span> 160	<span style="display:inline-block; width:100px; height:10px; background-color:orange;"></span> 130	<span style="display:inline-block; width:100px; height:10px; background-color:yellow;"></span> 75 (30)	Flat shape (small), side-view	E32-T25Y			
		41				Flat shape (small), flat-view	E32-T25Z			



\*1. The values for the minimum sensing object are representative values that indicate values obtained in standard mode with the sensing distance and sensitivity set to optimum values.

\*2.  Indicates models that allow free cutting.

 Flexible  Break-resistant  Fluoresresin coating

Standard models

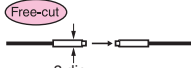
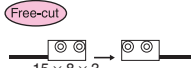
High-resolution mode 
  Standard mode 
  High-speed mode 
  Super-high-speed mode 
 \*When used in combination with the E3X-DA-S Amplifier Unit (general-purpose).

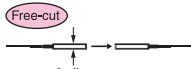
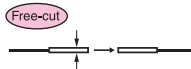
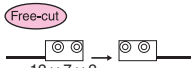
Type	Appearance (mm) *2	Dimensions page	Sensing distance (mm)			Standard object (min. sensing object) (mm) *1	Min. bending radius (mm)	Features	Model number
Break-resistant	Standard size  M4  3 dia.  15 x 8 x 3	42				1 dia. (0.005 dia.)	B R4	M4 screw	E32-T11
		42	900	680	450 (180)			3-dia. cylinder	E32-T12B
		42						Flat shape	E32-T15XB
	Small size	 M3  2 dia.  1.5 dia.	42			0.5 dia. (0.005 dia.)	B R4	M3 screw (small)	E32-T21
			42	240	200			110 (45)	2-dia. cylinder (small)
		42						1.5-dia. cylinder (small)	E32-T22B
		42	180	150	85 (35)			Flat shape (small)	E32-T25XB
Coating	 M4	42	900	680	450 (180)	U R4	M4 screw, fluorine coating	E32-T11U	







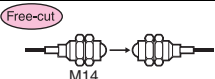
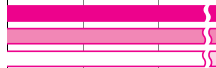
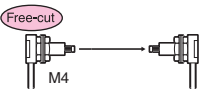
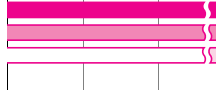
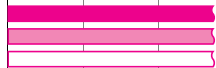

\*1. The values for the minimum sensing object are representative values that indicate values obtained in standard mode with the sensing distance and sensitivity set to optimum values.

\*2.  Indicates models that allow free cutting.

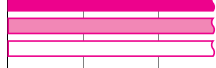
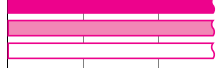
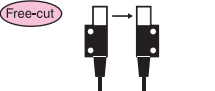
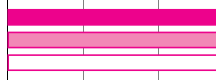
R Flexible 
 B Break-resistant 
 U Fluoresin coating

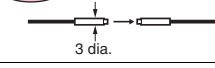
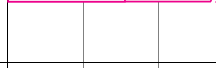
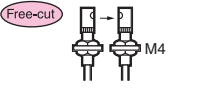
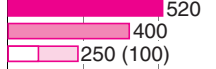
Through-beam Fiber Units **Special-beam models**

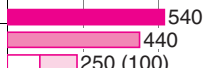
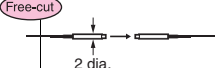
High-resolution mode 
  Standard mode 
  High-speed mode 
  Super-high-speed mode 
 \*When used in combination with the E3X-DA-S Amplifier Unit (general-purpose).

Type	Appearance (mm) *2	Dimensions page	Sensing distance (mm)	Standard object (min. sensing object) (mm) *1	Min. bending radius (mm)	Features	Model number
Long-distance, high-power		43	 20,000*3 20,000*3 10,000 (4,000)	10 dia.	R25	Large built-in lens, M14 screw	E32-T17L
		40 60	 4,000 3,700 2,400 (970)	4 dia. (0.1 dia.)	R1	M4 right angle	E32-T11N+ E39-F1
		40 60	 4,000*4 4,000*4 2,600 (1,500)			R25	M4 screw
		40 60	 4,000*4 3,700 2,400 (970)		R1	M4 screw, flexible fiber	E32-T11R+ E39-F1
		42 60	 4,000*4 3,600 2,300 (930)			R4	M4 screw, break-resistant
		43	 4,000*4 3,400 2,250 (900)			Screw mounting, side-view	E32-T14
		43	 1,700 1,330 870 (350)	1.4 dia. (0.01 dia.)	R25	M4 screw	E32-T11L
		43	 910 800 500 (180)				
		40 60	 520 400 250 (100)	3 dia. (0.1 dia.)	R1	M4 screw, side-view, flexible fiber	E32-T11R+ E39-F2
		42 60	 820 660 430 (160)			R4	M4 screw, side-view, break-resistant
		43	 540 440 250 (100)	0.9 dia. (0.005 dia.)	R10	M3 screw (small)	E32-T21L
		43	 540 440 250 (100)				

\*1. The values for the minimum sensing object are representative values that indicate values obtained in standard mode with the sensing distance and sensitivity set to optimum values.

\*2.  Indicates models that allow free cutting.





\*3. The optical fiber is 10 m long on each side, so the sensing distance is 20,000 mm.

\*4. The optical fiber is 2 m long on each side, so the sensing distance is 4,000 mm.

 Flexible  Break-resistant  Fluororesin coating

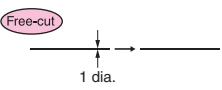
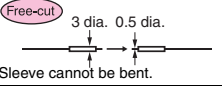
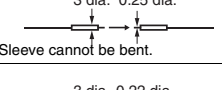
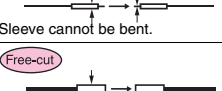
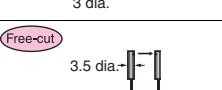
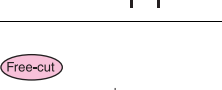
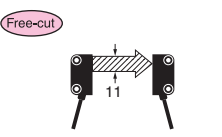
Special-beam models

High-resolution mode 
  Standard mode 
  High-speed mode 
  Super-high-speed mode 
 \*When used in combination with the E3X-DA-S Amplifier Unit (general-purpose).

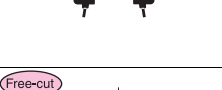
Type	Appearance (mm) *2	Dimensions page	Sensing distance (mm)	Standard object (min. sensing object) (mm)*1	Min. bending radius (mm)	Features	Model number
Ultracompact, thin-sleeve		44	<div style="display: flex; justify-content: space-between;"> <div style="width: 20px; height: 10px; background-color: #ff0000;"></div> 160</div> <div style="display: flex; justify-content: space-between;"> <div style="width: 20px; height: 10px; background-color: #ff6666;"></div> 130</div> <div style="display: flex; justify-content: space-between;"> <div style="width: 20px; height: 10px; background-color: #ff9999;"></div> 75 (30)</div>	0.5 dia. (0.005 dia.)	R1	1-dia. cylinder, flexible fiber	E32-T223R
		44	<div style="display: flex; justify-content: space-between;"> <div style="width: 20px; height: 10px; background-color: #ff0000;"></div> 53</div> <div style="display: flex; justify-content: space-between;"> <div style="width: 20px; height: 10px; background-color: #ff6666;"></div> 44</div> <div style="display: flex; justify-content: space-between;"> <div style="width: 20px; height: 10px; background-color: #ff9999;"></div> 25 (10)</div>	0.25 dia. (0.005 dia.)		R10	0.5-dia. sleeve; 0.25-dia. opening
		44	<div style="display: flex; justify-content: space-between;"> <div style="width: 20px; height: 10px; background-color: #ff0000;"></div> 12</div> <div style="display: flex; justify-content: space-between;"> <div style="width: 20px; height: 10px; background-color: #ff6666;"></div> 10</div> <div style="display: flex; justify-content: space-between;"> <div style="width: 20px; height: 10px; background-color: #ff9999;"></div> 6 (4)</div>	0.125 dia. (0.005 dia.)	0.25-dia. sleeve, 0.125-dia. opening		E32-T333-S5
		44	<div style="display: flex; justify-content: space-between;"> <div style="width: 20px; height: 10px; background-color: #ff0000;"></div> 6</div> <div style="display: flex; justify-content: space-between;"> <div style="width: 20px; height: 10px; background-color: #ff6666;"></div> 5</div> <div style="display: flex; justify-content: space-between;"> <div style="width: 20px; height: 10px; background-color: #ff9999;"></div> 3 (2)</div>	0.1 dia. (0.005 dia.)	0.22-dia. sleeve, 0.1-dia. opening		E32-T334-S5
Fine-beam		44	<div style="display: flex; justify-content: space-between;"> <div style="width: 20px; height: 10px; background-color: #ff0000;"></div> 2,500</div> <div style="display: flex; justify-content: space-between;"> <div style="width: 20px; height: 10px; background-color: #ff6666;"></div> 1,900</div> <div style="display: flex; justify-content: space-between;"> <div style="width: 20px; height: 10px; background-color: #ff9999;"></div> 1,250 (500)</div>	1.7 dia. (0.1 dia.)	R10	3-dia. cylinder	E32-T22S
		44	<div style="display: flex; justify-content: space-between;"> <div style="width: 20px; height: 10px; background-color: #ff0000;"></div> 1,750</div> <div style="display: flex; justify-content: space-between;"> <div style="width: 20px; height: 10px; background-color: #ff6666;"></div> 1,300</div> <div style="display: flex; justify-content: space-between;"> <div style="width: 20px; height: 10px; background-color: #ff9999;"></div> 870 (350)</div>	2 dia. (0.1 dia.)		3.5-dia. cylinder, side-view	E32-T24S
Area-sensing		45	<div style="display: flex; justify-content: space-between;"> <div style="width: 20px; height: 10px; background-color: #ff0000;"></div> 1,100</div> <div style="display: flex; justify-content: space-between;"> <div style="width: 20px; height: 10px; background-color: #ff6666;"></div> 840</div> <div style="display: flex; justify-content: space-between;"> <div style="width: 20px; height: 10px; background-color: #ff9999;"></div> 560 (220)</div>	(0.2 dia.) *3	R1	Area width: 11 mm	E32-T16PR
	45	<div style="display: flex; justify-content: space-between;"> <div style="width: 20px; height: 10px; background-color: #ff0000;"></div> 1,500</div> <div style="display: flex; justify-content: space-between;"> <div style="width: 20px; height: 10px; background-color: #ff6666;"></div> 1,100</div> <div style="display: flex; justify-content: space-between;"> <div style="width: 20px; height: 10px; background-color: #ff9999;"></div> 750 (300)</div>	R10				E32-T16P
		45	<div style="display: flex; justify-content: space-between;"> <div style="width: 20px; height: 10px; background-color: #ff0000;"></div> 980</div> <div style="display: flex; justify-content: space-between;"> <div style="width: 20px; height: 10px; background-color: #ff6666;"></div> 750</div> <div style="display: flex; justify-content: space-between;"> <div style="width: 20px; height: 10px; background-color: #ff9999;"></div> 480 (190)</div>	(0.3 dia.) *3	R1	Area width: 11 mm; side-view	E32-T16JR
	45	<div style="display: flex; justify-content: space-between;"> <div style="width: 20px; height: 10px; background-color: #ff0000;"></div> 1,300</div> <div style="display: flex; justify-content: space-between;"> <div style="width: 20px; height: 10px; background-color: #ff6666;"></div> 1,000</div> <div style="display: flex; justify-content: space-between;"> <div style="width: 20px; height: 10px; background-color: #ff9999;"></div> 650 (260)</div>	R10				E32-T16J
		44	<div style="display: flex; justify-content: space-between;"> <div style="width: 20px; height: 10px; background-color: #ff0000;"></div> 1,700</div> <div style="display: flex; justify-content: space-between;"> <div style="width: 20px; height: 10px; background-color: #ff6666;"></div> 1,300</div> <div style="display: flex; justify-content: space-between;"> <div style="width: 20px; height: 10px; background-color: #ff9999;"></div> 850 (340)</div>	(0.3 dia.) *3	R1	Area width: 30 mm	E32-T16WR
	44	<div style="display: flex; justify-content: space-between;"> <div style="width: 20px; height: 10px; background-color: #ff0000;"></div> 2,300</div> <div style="display: flex; justify-content: space-between;"> <div style="width: 20px; height: 10px; background-color: #ff6666;"></div> 1,800</div> <div style="display: flex; justify-content: space-between;"> <div style="width: 20px; height: 10px; background-color: #ff9999;"></div> 1,150 (450)</div>	R10				E32-T16W
		45	<div style="display: flex; justify-content: space-between;"> <div style="width: 20px; height: 10px; background-color: #ff0000;"></div> 3,700</div> <div style="display: flex; justify-content: space-between;"> <div style="width: 20px; height: 10px; background-color: #ff6666;"></div> 2,800</div> <div style="display: flex; justify-content: space-between;"> <div style="width: 20px; height: 10px; background-color: #ff9999;"></div> 1,850 (740)</div>	(0.6 dia.) *4	R25	Area width: 10 mm; long distance	E32-T16
	44	<div style="display: flex; justify-content: space-between;"> <div style="width: 20px; height: 10px; background-color: #ff0000;"></div> 750</div> <div style="display: flex; justify-content: space-between;"> <div style="width: 20px; height: 10px; background-color: #ff6666;"></div> 610</div> <div style="display: flex; justify-content: space-between;"> <div style="width: 20px; height: 10px; background-color: #ff9999;"></div> 350 (140)</div>	2 dia. (0.1 dia.)	Multi-point detection (4-head)		E32-M21	

\*1. The values for the minimum sensing object are representative values that indicate values obtained in standard mode with the sensing distance and sensitivity set to optimum values.



\*2.  Indicates models that allow free cutting.

\*3. This is the value for which detection is possible within the sensing area, with the sensing distance set to 300 mm. (The sensing object is stationary.)

\*4. This is the value for which detection is possible within the sensing area, with the sensing distance set to give a digital value of 1,000. (The sensing object is stationary.)

Through-beam Fiber Units Environment-resistant models

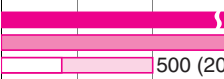
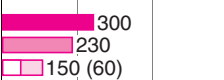
High-resolution mode 
  Standard mode 
  High-speed mode 
  Super-high-speed mode 
 \*When used in combination with the E3X-DA-S Amplifier Unit (general-purpose).

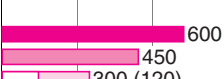
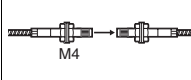
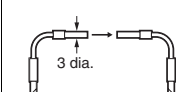
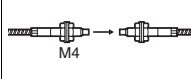
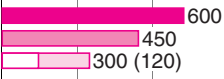
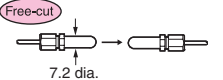
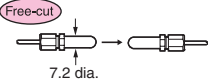
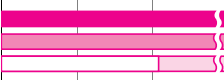
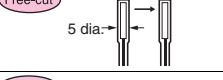
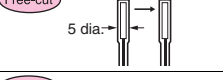
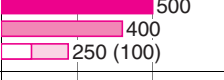
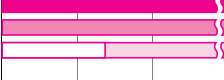
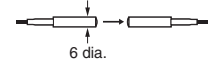
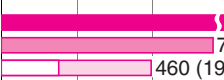
Type	Appearance (mm) *2	Dimensions page	Sensing distance (mm)	Standard object (min. sensing object) (mm)*1	Min. bending radius (mm)	Features	Model number	
Heat-resistant	150°C *5 	46		1,000 760 500 (200)	1.5 dia. (0.1 dia.)	R35	Heat-resistant up to 150°C	E32-T51
		46		300 230 150 (60)			Heat-resistant up to 150°C; side-view	E32-T54
	200°C *6 	46		360 280 180 (70)	1 dia. (0.005 dia.)	R10	Heat-resistant up to 200°C	E32-T81R-S
		46 60		600 450 300 (120)	3 dia. (0.1 dia.)	R25	Heat-resistant up to 200°C; side-view	E32-T61-S+ E39-F2
		46 60		4,000*7 3,400 2,200 (900)	4 dia. (0.1 dia.)		Heat-resistant up to 200°C, long distance	E32-T61-S+ E39-F1
		46		1,750 1,300 870 (350)	1.7 dia. (0.1 dia.)	Heat-resistant up to 200°C; L-shaped; long distance	E32-T84S-S	
350°C *6 	46		600 450 300 (120)	1 dia. (0.005 dia.)		Heat-resistant up to 350°C	E32-T61-S	
Chemical-resistant	Free-cut 	46		2,500 2,000 1,300 (520)	4 dia. (0.1 dia.)	R4	Fluororesin cover, round head	E32-T11F
		46		4,000*7 3,000 2,000 (800)		Fluororesin cover, long distance	E32-T12F	
	Free-cut 	46		500 400 250 (100)	3 dia. (0.1 dia.)	R40	Fluororesin cover, side-view	E32-T14F
	Free-cut 	46		1,800 1,400 900 (350)	4 dia. (0.1 dia.)		Fluororesin cover, heat-resistant up to 150°C *5	E32-T51F
		46		920 700 460 (190)	1 dia. (0.005 dia.)	R10	Fluororesin cover, heat-resistant up to 200°C *6	E32-T81F-S

\*1. The values for the minimum sensing object are representative values that indicate values obtained in standard mode with the sensing distance and sensitivity set to optimum values.

\*2. Free-cut Indicates models that allow free cutting.

\*3. This is the value for which detection is possible within the sensing area, with the sensing distance set to 300 mm. (The sensing object is stationary.)

\*4. This is the value for which detection is possible within the sensing area, with the sensing distance set to give a digital value of 1,000. (The sensing object is stationary.)

\*5. For continuous operation, use the products within a temperature range of -40°C to 130°C.



\*6. The maximum temperature that can be withstood varies with the location. Refer to dimensions diagrams for details.

\*7. The optical fiber is 2 m long on each side, so the sensing distance is 4,000 mm.





Environment-resistant models

High-resolution mode 
  Standard mode 
  High-speed mode 
  Super-high-speed mode 
 \*When used in combination with the E3X-DA-S Amplifier Unit (general-purpose).

Type	Appearance (mm)	Dimensions page	Sensing distance (mm)	Standard object (min. sensing object) (mm) *	Min. bending radius (mm)	Features	Model number	
Vacuum-resistant		47	<div style="display: flex; justify-content: space-between;"> <div style="width: 20%;"><span style="background-color: #ff0000; width: 100%; height: 100%;"></span> 260</div> <div style="width: 20%;"><span style="background-color: #ff6666; width: 100%; height: 100%;"></span> 200</div> <div style="width: 20%;"><span style="background-color: #ffcccc; width: 100%; height: 100%;"></span> 130 (50)</div> </div>	1.2 dia. (0.01 dia.)	R30	M4 screw, heat-resistant up to 120°C	E32-T51V 1M	
		47 47	<div style="display: flex; justify-content: space-between;"> <div style="width: 20%;"><span style="background-color: #ff0000; width: 100%; height: 100%;"></span> 1,350</div> <div style="width: 20%;"><span style="background-color: #ff6666; width: 100%; height: 100%;"></span> 1,000</div> <div style="width: 20%;"><span style="background-color: #ffcccc; width: 100%; height: 100%;"></span> 680 (260)</div> </div>	4 dia. (0.1 dia.)		M4 screw, heat-resistant up to 120°C, long distance	E32-T51V 1M+ E39-F1V	
		47	<div style="display: flex; justify-content: space-between;"> <div style="width: 20%;"><span style="background-color: #ff0000; width: 100%; height: 100%;"></span> 210</div> <div style="width: 20%;"><span style="background-color: #ff6666; width: 100%; height: 100%;"></span> 130</div> <div style="width: 20%;"><span style="background-color: #ffcccc; width: 100%; height: 100%;"></span> 100 (35)</div> </div>	1.2 dia. (0.01 dia.)		L-shaped, heat-resistant up to 120°C	E32-T54V 1M	
		47 47	<div style="display: flex; justify-content: space-between;"> <div style="width: 20%;"><span style="background-color: #ff0000; width: 100%; height: 100%;"></span> 660</div> <div style="width: 20%;"><span style="background-color: #ff6666; width: 100%; height: 100%;"></span> 500</div> <div style="width: 20%;"><span style="background-color: #ffcccc; width: 100%; height: 100%;"></span> 330 (180)</div> </div>	4 dia. (0.1 dia.)		L-shaped, heat-resistant up to 120°C, long distance	E32-T54V 1M+ E39-F1V	
		47	<div style="display: flex; justify-content: space-between;"> <div style="width: 20%;"><span style="background-color: #ff0000; width: 100%; height: 100%;"></span> 630</div> <div style="width: 20%;"><span style="background-color: #ff6666; width: 100%; height: 100%;"></span> 480</div> <div style="width: 20%;"><span style="background-color: #ffcccc; width: 100%; height: 100%;"></span> 320 (130)</div> </div>	2 dia. (0.1 dia.)		R25	L-shaped, heat-resistant up to 200°C, long distance	E32-T84SV 1M

\* The values for the minimum sensing object are representative values that indicate values obtained in standard mode with the sensing distance and sensitivity set to optimum values.

Flanges

Appearance (mm)	Dimensions page	Type	Model number
	47	4-channel flange	E32-VF4
	47	1-channel flange	E32-VF1

Lens Units

Appearance (mm)	Dimensions page	Type	Quantity	Remarks
	47	E39-F1V	2	Long-distance Lens Unit Can be used for the E32-T51V and the E32-T54V.

Fiber Units for Atmospheric-pressure Side

Appearance (mm)	Dimensions page	Type	Model number
	47	Amplifier-Flange Connection Fiber	E32-T10V 2M





\* Free-cut Indicates models that allow free cutting.

Mounting Brackets

Appearance (mm)	Dimensions page	Type	Quantity	Remarks
	47	E39-L54V	2	Can be used for the E32-T54V.

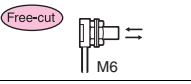
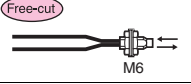
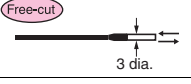
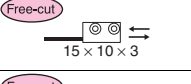
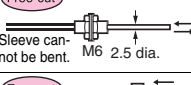
Fiber Units with Reflective Sensors Standard models

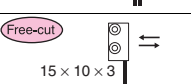
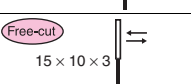
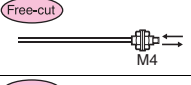
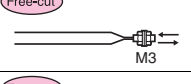
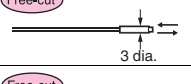
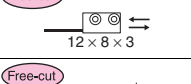
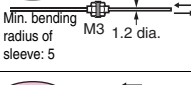
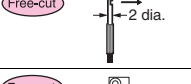
High-resolution mode 
  Standard mode 
  High-speed mode 
  Super-high-speed mode 
 \*When used in combination with the E3X-DA-S Amplifier Unit (general-purpose).

Type	Appearance (mm) *3	Dimensions page	Sensing distance (mm) *1			(Min. sensing object) (mm) *2	Min. bending radius (mm)	Features	Model number	
Flexible (new standard)	Standard size	 Free-cut M6 right angle	48					M6 right angle	E32-D11N	
		 Free-cut M6 screw	48					M6 screw	E32-D11R	
		 Free-cut 3 dia.	48	<span style="display: inline-block; width: 10px; height: 10px; background-color: #FF0000; border: 1px solid black;"></span> 300	<span style="display: inline-block; width: 10px; height: 10px; background-color: #FF6666; border: 1px solid black;"></span> 170	<span style="display: inline-block; width: 10px; height: 10px; background-color: #FFCC99; border: 1px solid black;"></span> 120 (50)			3-dia. cylinder	E32-D12R
		 Free-cut 15 x 10 x 3	48						Flat shape	E32-D15XR
		 Free-cut M6 2.5 dia. Sleeve cannot be bent.	48						M6 screw, with sleeve	E32-DC200BR E32-DC200B4R
		 Free-cut 6 dia.	49	<span style="display: inline-block; width: 10px; height: 10px; background-color: #FF0000; border: 1px solid black;"></span> 80	<span style="display: inline-block; width: 10px; height: 10px; background-color: #FF6666; border: 1px solid black;"></span> 45	<span style="display: inline-block; width: 10px; height: 10px; background-color: #FFCC99; border: 1px solid black;"></span> 30 (14)			6-dia. cylinder, side-view	E32-D14LR
		 Free-cut 15 x 10 x 3	49	<span style="display: inline-block; width: 10px; height: 10px; background-color: #FF0000; border: 1px solid black;"></span> 70	<span style="display: inline-block; width: 10px; height: 10px; background-color: #FF6666; border: 1px solid black;"></span> 40	<span style="display: inline-block; width: 10px; height: 10px; background-color: #FFCC99; border: 1px solid black;"></span> 26 (12)			Flat shape, side-view	E32-D15YR
		 Free-cut 15 x 10 x 3	49						Flat shape, flat-view	E32-D15ZR
							(0.005 dia.)	<span style="border: 1px solid black; border-radius: 50%; padding: 2px;">R</span> R1		
	Small size	 Free-cut M4	48					M4 screw (small)	E32-D211R	
		 Free-cut M3	48					M3 screw (small)	E32-D21R	
		 Free-cut 3 dia.	48	<span style="display: inline-block; width: 10px; height: 10px; background-color: #FF0000; border: 1px solid black;"></span> 50	<span style="display: inline-block; width: 10px; height: 10px; background-color: #FF6666; border: 1px solid black;"></span> 30	<span style="display: inline-block; width: 10px; height: 10px; background-color: #FFCC99; border: 1px solid black;"></span> 20 (8)			3-dia. cylinder (small)	E32-D22R
		 Free-cut 12 x 8 x 3	48						Flat panel (small)	E32-D25XR
		 Free-cut M3 1.2 dia. Min. bending radius of sleeve: 5	48						M3 screw (small), with sleeve	E32-DC200FR E32-DC200F4R
		 Free-cut 2 dia.	49	<span style="display: inline-block; width: 10px; height: 10px; background-color: #FF0000; border: 1px solid black;"></span> 26	<span style="display: inline-block; width: 10px; height: 10px; background-color: #FF6666; border: 1px solid black;"></span> 15	<span style="display: inline-block; width: 10px; height: 10px; background-color: #FFCC99; border: 1px solid black;"></span> 10 (4)			2-dia. cylinder (small), side-view	E32-D24R
		 Free-cut 12 x 8 x 2	49	<span style="display: inline-block; width: 10px; height: 10px; background-color: #FF0000; border: 1px solid black;"></span> 14	<span style="display: inline-block; width: 10px; height: 10px; background-color: #FF6666; border: 1px solid black;"></span> 8	<span style="display: inline-block; width: 10px; height: 10px; background-color: #FFCC99; border: 1px solid black;"></span> 5 (2)			Flat shape (small), side-view	E32-D25YR
		 Free-cut 12 x 8 x 2	49						Flat shape (small), flat-view	E32-D25ZR

\*1. The sensing distances are for white paper.  
 \*2. The values for the minimum sensing object are representative values that indicate values obtained in standard mode with the sensing distance and sensitivity set to optimum values.  
 \*3. Free-cut Indicates models that allow free cutting.  
R Flexible B Break-resistant U Fluoresin coating

Standard models

High-resolution mode 
  Standard mode 
  High-speed mode 
  Super-high-speed mode 
 \*When used in combination with the E3X-DA-S Amplifier Unit (general-purpose).

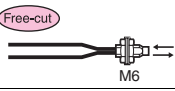
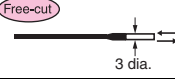
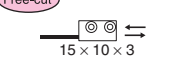
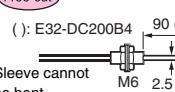
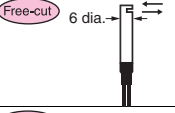
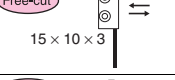
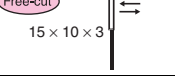
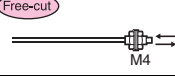
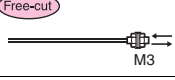
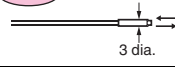
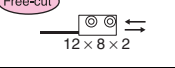
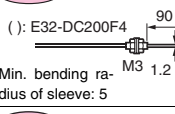
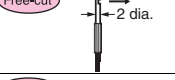
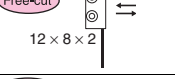
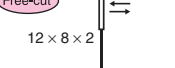
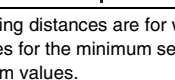
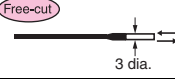
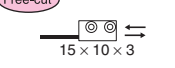
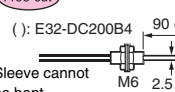
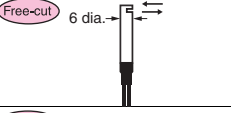
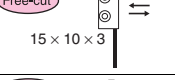
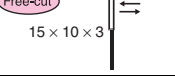
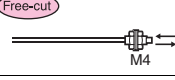
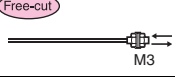
Type	Appearance (mm) *3	Dimensions page	Sensing distance (mm) *1		(Min. sensing object) (mm) *2	Min. bending radius (mm)	Features	Model number		
Standard	Standard size		48	<span style="background-color: #ff0000; width: 100px; height: 10px;"></span> 500		(0.005 dia.)	R25	M6 screw	E32-DC200	
			48	<span style="background-color: #ff0000; width: 100px; height: 10px;"></span> 400				3-dia. cylinder	E32-D12	
			48	<span style="background-color: #ff0000; width: 100px; height: 10px;"></span> 500				Flat shape	E32-D15X	
			48	<span style="background-color: #ff0000; width: 100px; height: 10px;"></span> 300	<span style="background-color: #ff9999; width: 100px; height: 10px;"></span> 200 (90)			M6 screw, with sleeve	E32-DC200B E32-DC200B4	
			49	<span style="background-color: #ff0000; width: 100px; height: 10px;"></span> 200	<span style="background-color: #ff6666; width: 100px; height: 10px;"></span> 110 <span style="background-color: #ff9999; width: 100px; height: 10px;"></span> 80 (36)			6-dia. cylinder, side-view	E32-D14L	
			49	<span style="background-color: #ff0000; width: 100px; height: 10px;"></span> 170	<span style="background-color: #ff6666; width: 100px; height: 10px;"></span> 100 <span style="background-color: #ff9999; width: 100px; height: 10px;"></span> 65 (30)			Flat shape, side-view	E32-D15Y	
			49					Flat shape, flat-view	E32-D15Z	
			48					M4 screw (small)	E32-D211	
			48					M3 screw (small)	E32-DC200E	
		48	<span style="background-color: #ff0000; width: 100px; height: 10px;"></span> 130	<span style="background-color: #ff6666; width: 100px; height: 10px;"></span> 80 <span style="background-color: #ff9999; width: 100px; height: 10px;"></span> 50 (22)	3-dia. cylinder (small)		E32-D22			
		48			Flat shape (small)		E32-D25X			
		48			M3 screw (small), with sleeve		E32-DC200F E32-DC200F4			
		49	<span style="background-color: #ff0000; width: 100px; height: 10px;"></span> 50	<span style="background-color: #ff6666; width: 100px; height: 10px;"></span> 30 <span style="background-color: #ff9999; width: 100px; height: 10px;"></span> 20 (8)	2-dia. cylinder (small), side-view		E32-D24			
		49	<span style="background-color: #ff0000; width: 100px; height: 10px;"></span> 35	<span style="background-color: #ff6666; width: 100px; height: 10px;"></span> 20 <span style="background-color: #ff9999; width: 100px; height: 10px;"></span> 12 (6)	Flat shape (small), side-view		E32-D25Y			
		49			Flat shape (small), flat-view		E32-D25Z			
	Small size		48							
			48							
			48							
		48								
		48								
		49								
		49								
		49								
		49								

\*1. The sensing distances are for white paper.



\*2. The values for the minimum sensing object are representative values that indicate values obtained in standard mode with the sensing distance and sensitivity set to optimum values.



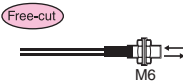
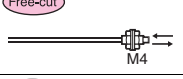

\*3.  Indicates models that allow free cutting.

 Flexible  Break-resistant  Fluororesin coating

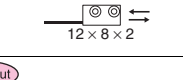
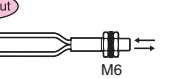
Fiber Units with Reflective Sensors Standard models



High-resolution mode 
  Standard mode 
  High-speed mode 
 \*When used in combination with the E3X-DA-S Amplifier Unit (general-purpose).  
 Super-high-speed mode

Type	Appearance (mm) *3	Dimensions page	Sensing distance (mm) *1			(Min. sensing object) (mm) *2	Min. bending radius (mm)	Features	Model number								
Break-resistant	Standard size 	50	<span style="background-color: #ff0000; width: 20px; height: 10px;"></span> 300	<span style="background-color: #ff6666; width: 20px; height: 10px;"></span> 170	<span style="background-color: #ff9999; width: 20px; height: 10px;"></span> 120 (50)	(0.005 dia.)	B R4	M6 screw	E32-D11								
		50	<span style="background-color: #ff0000; width: 20px; height: 10px;"></span> 110	<span style="background-color: #ff6666; width: 20px; height: 10px;"></span> 70	<span style="background-color: #ff9999; width: 20px; height: 10px;"></span> 45 (20)			Flat shape	E32-D15XB								
	Small size		50	<span style="background-color: #ff0000; width: 20px; height: 10px;"></span> 50	<span style="background-color: #ff6666; width: 20px; height: 10px;"></span> 30			<span style="background-color: #ff9999; width: 20px; height: 10px;"></span> 20 (8)	(0.005 dia.)	B R4	M4 screw (small)	E32-D21B					
			50	<span style="background-color: #ff0000; width: 20px; height: 10px;"></span> 85	<span style="background-color: #ff6666; width: 20px; height: 10px;"></span> 50			<span style="background-color: #ff9999; width: 20px; height: 10px;"></span> 30 (15)			3-dia. cylinder (small)	E32-D221B					
			50	<span style="background-color: #ff0000; width: 20px; height: 10px;"></span> 300	<span style="background-color: #ff6666; width: 20px; height: 10px;"></span> 170			<span style="background-color: #ff9999; width: 20px; height: 10px;"></span> 120 (50)			(0.005 dia.)	B R4	M3 screw (small)	E32-D21			
			50	<span style="background-color: #ff0000; width: 20px; height: 10px;"></span> 170	<span style="background-color: #ff6666; width: 20px; height: 10px;"></span> 120 (50)								1.5-dia. cylinder (small)	E32-D22B			
				50	<span style="background-color: #ff0000; width: 20px; height: 10px;"></span> 300			<span style="background-color: #ff6666; width: 20px; height: 10px;"></span> 170					<span style="background-color: #ff9999; width: 20px; height: 10px;"></span> 120 (50)	(0.005 dia.)	B R4	Flat shape (small)	E32-D25XB
				50	<span style="background-color: #ff0000; width: 20px; height: 10px;"></span> 300			<span style="background-color: #ff6666; width: 20px; height: 10px;"></span> 170					<span style="background-color: #ff9999; width: 20px; height: 10px;"></span> 120 (50)			M6 screw, fluorine coating	E32-D11U
Coating		50	<span style="background-color: #ff0000; width: 20px; height: 10px;"></span> 300	<span style="background-color: #ff6666; width: 20px; height: 10px;"></span> 170	<span style="background-color: #ff9999; width: 20px; height: 10px;"></span> 120 (50)	(0.005 dia.)	U R4										

\*1. The sensing distances are for white paper.  
 \*2. The values for the minimum sensing object are representative values that indicate values obtained in standard mode with the sensing distance and sensitivity set to optimum values.  
 \*3.  Indicates models that allow free cutting.  
 Flexible  Break-resistant  Fluoresin coating

Special-beam models

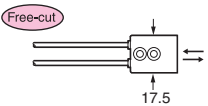

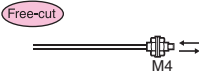
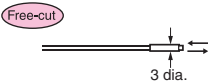
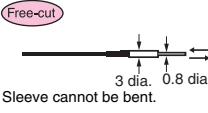
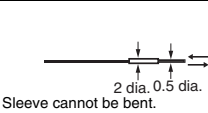





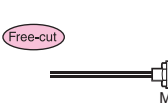
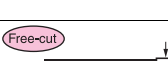

High-resolution mode 
  Standard mode 
  High-speed mode 
  Super-high-speed mode 
 \*When used in combination with the E3X-DA-S Amplifier Unit (general-purpose).

Type	Appearance (mm) *3	Dimensions page	Sensing distance (mm) *1	(Min. sensing object) (mm) *2	Min. bending radius (mm)	Features	Model number	
Long-distance, high-power		51	<div style="background-color: #008080; width: 100%; height: 10px; margin-bottom: 2px;"></div> <div style="background-color: #FF69B4; width: 100%; height: 10px; margin-bottom: 2px;"></div> <div style="background-color: #FFDAB9; width: 100%; height: 10px; margin-bottom: 2px;"></div> <div style="background-color: #FFB6C1; width: 100%; height: 10px; margin-bottom: 2px;"></div> 40 to 1,000 40 to 700 40 to 450 (40 to 240)	---	(0.005 dia.)	B R4	Large built-in lens, screw mounting	E32-D16
		51	<div style="background-color: #008080; width: 100%; height: 10px; margin-bottom: 2px;"></div> <div style="background-color: #FF69B4; width: 100%; height: 10px; margin-bottom: 2px;"></div> <div style="background-color: #FFDAB9; width: 100%; height: 10px; margin-bottom: 2px;"></div> <div style="background-color: #FFB6C1; width: 100%; height: 10px; margin-bottom: 2px;"></div> 650 400 260 (110)			R25	M6 screw	E32-D11L
		51	<div style="background-color: #008080; width: 100%; height: 10px; margin-bottom: 2px;"></div> <div style="background-color: #FF69B4; width: 100%; height: 10px; margin-bottom: 2px;"></div> <div style="background-color: #FFDAB9; width: 100%; height: 10px; margin-bottom: 2px;"></div> <div style="background-color: #FFB6C1; width: 100%; height: 10px; margin-bottom: 2px;"></div> 210 130 80 (35)			R10	M4 screw	E32-D21L
		51	<div style="background-color: #008080; width: 100%; height: 10px; margin-bottom: 2px;"></div> <div style="background-color: #FF69B4; width: 100%; height: 10px; margin-bottom: 2px;"></div> <div style="background-color: #FFDAB9; width: 100%; height: 10px; margin-bottom: 2px;"></div> <div style="background-color: #FFB6C1; width: 100%; height: 10px; margin-bottom: 2px;"></div> 210 130 80 (35)				3-dia. cylinder	E32-D22L
Ultracompact, thin-sleeve		51	<div style="background-color: #008080; width: 100%; height: 10px; margin-bottom: 2px;"></div> <div style="background-color: #FF69B4; width: 100%; height: 10px; margin-bottom: 2px;"></div> <div style="background-color: #FFDAB9; width: 100%; height: 10px; margin-bottom: 2px;"></div> <div style="background-color: #FFB6C1; width: 100%; height: 10px; margin-bottom: 2px;"></div> 25 16 10 (4)		R4	0.8-dia. sleeve	E32-D33	
		51	<div style="background-color: #008080; width: 100%; height: 10px; margin-bottom: 2px;"></div> <div style="background-color: #FF69B4; width: 100%; height: 10px; margin-bottom: 2px;"></div> <div style="background-color: #FFDAB9; width: 100%; height: 10px; margin-bottom: 2px;"></div> <div style="background-color: #FFB6C1; width: 100%; height: 10px; margin-bottom: 2px;"></div> 5 3 2 (0.8)			0.5-dia. sleeve	E32-D331	

- \*1. The sensing distances are for white paper.
- \*2. The values for the minimum sensing object are representative values that indicate values obtained in standard mode with the sensing distance and sensitivity set to optimum values.
- \*3.  Indicates models that allow free cutting.

Fiber Units with Reflective Sensors Special-beam models



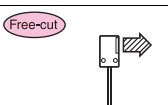
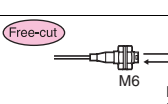

High-resolution mode Standard mode High-speed mode Super-high-speed mode \*When used in combination with the E3X-DA-S Amplifier Unit (general-purpose).

Type	Appearance (mm) *3	Dimensions page	Sensing distance (mm) *1			(Min. sensing object) (mm) *2	Min. bending radius (mm)	Features	Model number	
Coaxial, small-spot		52	280 170 160 (50)			(0.005 dia.)	R4	M6 right angle	E32-C11N	
		52	40 25 23 (7)					M3 right angle	E32-C31N	
		52	250 150 100 (45)					500	M6 screw	E32-CC200R
		52	300 200 (90)				E32-CC200			
		52	250 150 100 (45)					3-dia. cylinder	E32-D32L	
		52	120 75 50 (22)					M3 screw (small)	E32-C31	
		52						2-dia. cylinder (small)	E32-D32	
		52	6 to 15 mm; spot diameter: 0.1 to 0.6 mm					R25	Small spot (variable)	E32-C42+ E39-F3A
		60	Spot diameter of 0.5 to 1 mm at distances in the range 6 to 15 mm				Free-cut			E32-D32+ E39-F3A
		52	Spot diameter of 0.1 mm at 7 mm					R25	Small spot	E32-C41+ E39-F3A-5
		60	Spot diameter of 0.5 mm at 7 mm				Free-cut			E32-C31+ E39-F3A-5
		52	Spot diameter of 0.2 mm at 17 mm					R25	Long distance, small spot	E32-C41+ E39-F3B
		60	Spot diameter of 0.5 mm at 17 mm				Free-cut			E32-C31+ E39-F3B
	52	Spot diameter of 4 mm max. at distances in the range 0 to 20 mm					Long-distance sensing, parallel light	E32-C31+ E39-F3C		
Area-sensing		53	250 150 100 (45)			(0.005 dia.)	B R4	Beam width: 11 mm	E32-D36P1	
Retroreflective		53	10 to 250 10 to 250 10 to 250 (10 to 250)			(0.1 dia.)	R10	M6 screw	E32-R21+ E39-R3 (Attached)	
		53	150 to 1,500 150 to 1,500 150 to 1,500 (150 to 1,500)			(0.2 dia.)	R25	Screw mounting, long distance	E32-R16+ E39-R1 (Attached)	

\*1. The sensing distances are for white paper.  
 \*2. The values for the minimum sensing object are representative values that indicate values obtained in standard mode with the sensing distance and sensitivity set to optimum values.  
 \*3. Free-cut Indicates models that allow free cutting.  
 R Flexible B Break-resistant U Fluoresin coating

Special-beam models

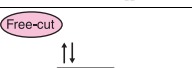
  High-resolution mode  
   Standard mode  
   High-speed mode  
 \*When used in combination with the E3X-DA-S Amplifier Unit (general-purpose).  
  Super-high-speed mode

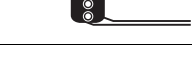
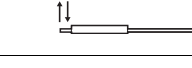
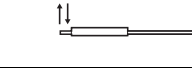
Type	Appearance (mm) *3	Dimensions page	Sensing distance (mm) *1			(Min. sensing object) (mm) *2	Min. bending radius (mm)	Features	Model number	
Convergent-reflective		54	3.3			(0.005 dia.)	R25	Small level differences, high power, side-view	E32-L25	
		54	3.3	3.3 (3.3)				Small level differences, top-view	E32-L25A	
		54	0 to 4	0 to 4	0 to 4 (0 to 4)		R10	Ultracompact, flat-view	E32-L24S	
		54	2 to 6 (center: 4)	2 to 6 (center: 4)	2 to 6 (2 to 6) (center: 4)			Heat resistant up to 105°C *4, top-view	E32-L24L	
		54	5.4 to 9 (center: 7.2)	5.4 to 9 (center: 7.2)	5.4 to 9 (5.4 to 9) (center: 7.2)			Heat resistant up to 105°C *4, top-view	E32-L25L	
		55	4 to 10	4 to 10	4 to 10 (4 to 10)		Soda glass with reflection factor of 7%	R25	Heat resistant up to 200°C, flat-view	E32-L86
		55	1 to 5	1 to 5	1 to 5				Heat resistant up to 300°C	E32-L64
		55	0 to 8	0 to 8	0 to 6				0 to 4	Ideal for detecting glass stock.

- \*1. The sensing distances are for white paper.
- \*2. The values for the minimum sensing object are representative values that indicate values obtained in standard mode with the sensing distance and sensitivity set to optimum values.
- \*3.  Indicates models that allow free cutting.
- \*4. For continuous operation, use the products within a temperature range of -40°C to 90°C.

Fiber Units with Reflective Sensors Environment-resistant models

High-resolution mode 
  Standard mode 
  High-speed mode 
  Super-high-speed mode 
 \*When used in combination with the E3X-DA-S Amplifier Unit (general-purpose).

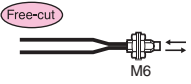
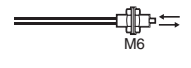
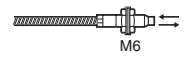
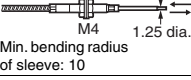
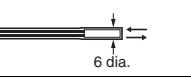
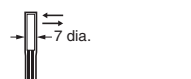
Type	Appearance (mm) *3	Dimensions page	Sensing distance (mm) *1	(Min. sensing object) (mm) *2	Min. bending radius (mm)	Features	Model number
Heat-resistant	150°C *4 	56	<span style="display: inline-block; width: 100px; height: 10px; background-color: #e91e63; border: 1px solid black; margin-right: 5px;"></span> 400 <span style="display: inline-block; width: 100px; height: 10px; background-color: #f06292; border: 1px solid black; margin-right: 5px;"></span> 230 <span style="display: inline-block; width: 100px; height: 10px; background-color: #fce4ec; border: 1px solid black; margin-right: 5px;"></span> 160 (72)	(0.005 dia.)	R35	Heat resistant up to 150°C	E32-D51
	200°C *5 	56	<span style="display: inline-block; width: 100px; height: 10px; background-color: #e91e63; border: 1px solid black; margin-right: 5px;"></span> 150 <span style="display: inline-block; width: 100px; height: 10px; background-color: #f06292; border: 1px solid black; margin-right: 5px;"></span> 90 <span style="display: inline-block; width: 100px; height: 10px; background-color: #fce4ec; border: 1px solid black; margin-right: 5px;"></span> 60 (27)		R10	Heat resistant up to 200°C	E32-D81R-S E32-D81R*6
	350°C *5 	56	<span style="display: inline-block; width: 100px; height: 10px; background-color: #e91e63; border: 1px solid black; margin-right: 5px;"></span> 100 <span style="display: inline-block; width: 100px; height: 10px; background-color: #f06292; border: 1px solid black; margin-right: 5px;"></span> 60 <span style="display: inline-block; width: 100px; height: 10px; background-color: #fce4ec; border: 1px solid black; margin-right: 5px;"></span> 40 (18)		R25	Heat resistant up to 350°C	E32-D61-S E32-D61*6
	400°C *5 	56	<span style="display: inline-block; width: 100px; height: 10px; background-color: #e91e63; border: 1px solid black; margin-right: 5px;"></span> 100 <span style="display: inline-block; width: 100px; height: 10px; background-color: #f06292; border: 1px solid black; margin-right: 5px;"></span> 60 <span style="display: inline-block; width: 100px; height: 10px; background-color: #fce4ec; border: 1px solid black; margin-right: 5px;"></span> 40 (18)		Heat resistant up to 400°C, with sleeve	E32-D73-S E32-D73*6	
Chemical-resistant	Free-cut 	56	<span style="display: inline-block; width: 100px; height: 10px; background-color: #e91e63; border: 1px solid black; margin-right: 5px;"></span> 160 <span style="display: inline-block; width: 100px; height: 10px; background-color: #f06292; border: 1px solid black; margin-right: 5px;"></span> 95 <span style="display: inline-block; width: 100px; height: 10px; background-color: #fce4ec; border: 1px solid black; margin-right: 5px;"></span> 65 (30)	(0.005 dia.)	R40	Fluoresin cover, long distance	E32-D12F
	Free-cut 	56	<span style="display: inline-block; width: 100px; height: 10px; background-color: #e91e63; border: 1px solid black; margin-right: 5px;"></span> 70 <span style="display: inline-block; width: 100px; height: 10px; background-color: #f06292; border: 1px solid black; margin-right: 5px;"></span> 40 <span style="display: inline-block; width: 100px; height: 10px; background-color: #fce4ec; border: 1px solid black; margin-right: 5px;"></span> 30 (10)			Fluoresin cover, side-view	E32-D14F

- \*1. The sensing distances are for white paper.
- \*2. The values for the minimum sensing object are representative values that indicate values obtained in standard mode with the sensing distance and sensitivity set to optimum values.
- \*3. Free-cut Indicates models that allow free cutting.
- \*4. For continuous operation, use the products within a temperature range of -40°C to 90°C.
- \*5. The maximum temperature that can be withstood varies with the location. Refer to dimensions diagrams for details.
- \*6. Order the Fiber Unit based on the Amplifier Unit. Use the E32-D□-S if the E3X-DA□-S, E3X-MDA□, or E3X-DAC□-S is used. Use the E32-D□ if any other Amplifier is used.





R Flexible 
 B Break-resistant 
 U Fluoresin coating

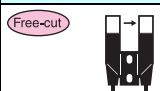
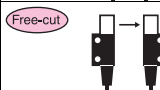
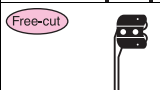
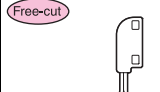
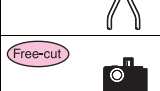
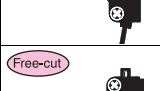

## Ordering Information

### Application-corresponding Fiber Units

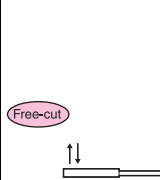
High-resolution mode  
  Standard mode  
  High-speed mode  
 \*When used in combination with the E3X-DA-S Amplifier Unit (general-purpose).  
 Super-high-speed mode

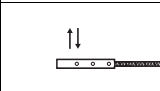
Type	Appearance (mm) *2	Dimensions page	Sensing distance (mm)	Standard object (min. sensing object) (mm)*1	Min. bending radius (mm)	Features	Model number												
Label-detection		57	<table border="1"> <tr><td style="background-color: #008080;">10</td><td></td><td></td><td></td></tr> <tr><td style="background-color: #FF69B4;">10</td><td></td><td></td><td></td></tr> <tr><td style="background-color: #FFD700;">10 (10)</td><td></td><td></td><td></td></tr> </table>	10				10				10 (10)				4 dia. (0.1 dia.)	R25	Slot sensor (no adjustment of optical axis required)	E32-G14
	10																		
10																			
10 (10)																			
	43	<table border="1"> <tr><td style="background-color: #008080;">4,500</td><td></td><td></td><td></td></tr> <tr><td style="background-color: #FF69B4;">3,400</td><td></td><td></td><td></td></tr> <tr><td style="background-color: #FFD700;">2,250 (900)</td><td></td><td></td><td></td></tr> </table>	4,500				3,400				2,250 (900)				Screw mounting, side-view	E32-T14			
4,500																			
3,400																			
2,250 (900)																			
Liquid-level detection		57	Applicable tube: Transparent tube with a diameter in the range 8 to 10 mm and a recommended wall thickness of 1 mm		R10	Compact	E32-L25T												
		57	Applicable tube: Transparent tube (no restriction on diameter)		R4	No restriction on tube diameter, resistant to bubbles and drops of water	E32-D36T												
		58	Applicable tube: Transparent tube with a diameter of 3.2, 6.4, or 9.5 mm and a recommended wall thickness of 1 mm			Light ON when fluid is present, resistant to bubbles and drops of water	E32-A01												
		58	Applicable tube: Transparent tube with a diameter in the range 6 to 13 mm and a recommended wall thickness of 1 mm			Light ON when fluid is not present, resistant to bubbles and drops of water	E32-A02												
		58	Liquid-contact models		R40	Heat resistant up to 200°C, fluororesin cover	E32-D82F1 E32-D82F2												
Glass-substrate-alignment		54	<table border="1"> <tr><td style="background-color: #008080;">0 to 15</td><td></td><td></td><td></td></tr> <tr><td style="background-color: #FF69B4;">0 to 15</td><td></td><td></td><td></td></tr> <tr><td style="background-color: #FFD700;">0 to 15 (0 to 12)</td><td></td><td></td><td></td></tr> </table>	0 to 15				0 to 15				0 to 15 (0 to 12)				Soda glass with reflection factor of 7%	R25	Variation of detection position within the detection range: 0.1 mm	E32-L16-N
		0 to 15																	
		0 to 15																	
	0 to 15 (0 to 12)																		
	58	<table border="1"> <tr><td style="background-color: #008080;">10 to 20</td><td></td><td></td><td></td></tr> <tr><td style="background-color: #FF69B4;">10 to 20</td><td></td><td></td><td></td></tr> <tr><td style="background-color: #FFD700;">10 to 20 (-)</td><td></td><td></td><td></td></tr> </table>	10 to 20				10 to 20				10 to 20 (-)				E32-A08				
10 to 20																			
10 to 20																			
10 to 20 (-)																			
58	<table border="1"> <tr><td style="background-color: #008080;">15 to 25</td><td></td><td></td><td></td></tr> <tr><td style="background-color: #FF69B4;">15 to 25</td><td></td><td></td><td></td></tr> <tr><td style="background-color: #FFD700;">10 to 20 (-)</td><td></td><td></td><td></td></tr> </table>	15 to 25				15 to 25				10 to 20 (-)				E32-A07E1*5 E32-A07E2*5					
15 to 25																			
15 to 25																			
10 to 20 (-)																			
	58	<table border="1"> <tr><td style="background-color: #008080;">5 to 18</td><td></td><td></td><td></td></tr> <tr><td style="background-color: #FF69B4;">5 to 18</td><td></td><td></td><td></td></tr> <tr><td style="background-color: #FFD700;">5 to 16 (-)</td><td></td><td></td><td></td></tr> </table>	5 to 18				5 to 18				5 to 16 (-)				Heat resistant up to 300°C *3, *4	E32-L66			
5 to 18																			
5 to 18																			
5 to 16 (-)																			
	54	<table border="1"> <tr><td style="background-color: #008080;">10 to 20</td><td></td><td></td><td></td></tr> <tr><td style="background-color: #FF69B4;">10 to 20</td><td></td><td></td><td></td></tr> <tr><td style="background-color: #FFD700;">10 to 20</td><td></td><td></td><td></td></tr> </table>	10 to 20				10 to 20				10 to 20				Heat resistant up to 300°C	E32-A08H2			
10 to 20																			
10 to 20																			
10 to 20																			

\*1. The values for the minimum sensing object are representative values that indicate values obtained in standard mode with the sensing distance and sensitivity set to optimum values.

\*2.  Indicates models that allow free cutting.



\*3. The maximum temperature that can be withstood varies with the location. Refer to dimensions diagrams for details.

\*4. These values are based on the assumption that there are no repeated sudden changes in temperature.

\*5. The characteristics for sensing object incline are different between the Attachments with model numbers ending in "E1" and "E2." Refer to page 52 for installation precautions.

Application-corresponding Fiber Units

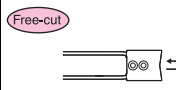
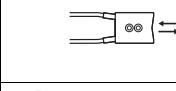
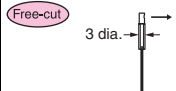
High-resolution mode 
  Standard mode 
  High-speed mode 
  Super-high-speed mode 
 \*When used in combination with the E3X-DA-S Amplifier Unit (general-purpose).

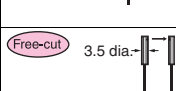
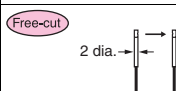
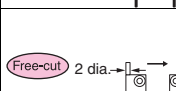
Type	Appearance (mm) *2	Dimensions page	Sensing distance (mm)	Standard object (min. sensing object) (mm)*1	Min. bending radius (mm)	Features	Model number	
Glass-substrate-mapping		59	<div style="background-color: #008080; width: 100%; height: 5px; margin-bottom: 2px;"></div> <div style="background-color: #FF69B4; width: 100%; height: 5px; margin-bottom: 2px;"></div> <div style="background-color: #FFDAB9; width: 100%; height: 5px; margin-bottom: 2px;"></div> <div style="background-color: #FFB6C1; width: 100%; height: 5px;"></div> 15 to 38 (center: 25) 15 to 38 (center: 25) 15 to 38 (center: 25) (-)	Edge of soda glass with reflection factor of 7% (t = 0.5 mm, rounded edge)	R25	Resistant to tilting	E32-A09	
		59	<div style="background-color: #008080; width: 100%; height: 5px; margin-bottom: 2px;"></div> <div style="background-color: #FF69B4; width: 100%; height: 5px; margin-bottom: 2px;"></div> <div style="background-color: #FFDAB9; width: 100%; height: 5px; margin-bottom: 2px;"></div> <div style="background-color: #FFB6C1; width: 100%; height: 5px;"></div> 20 to 30 (center: 25) 20 to 30 (center: 25) 20 to 30 (center: 25) (-)		R35	Heat resistant up to 150°C *3	E32-A09H	
		59	<div style="background-color: #008080; width: 100%; height: 5px; margin-bottom: 2px;"></div> <div style="background-color: #FF69B4; width: 100%; height: 5px; margin-bottom: 2px;"></div> <div style="background-color: #FFDAB9; width: 100%; height: 5px; margin-bottom: 2px;"></div> <div style="background-color: #FFB6C1; width: 100%; height: 5px;"></div> 20 to 30 (center: 25) 20 to 30 (center: 25) 20 to 30 (center: 25) (-)		R25	Heat resistant up to 300°C *4, *5	E32-A09H2	
Wafer-mapping		59		2 dia. (0.1 dia.)	<div style="background-color: #008080; width: 100%; height: 5px; margin-bottom: 2px;"></div> <div style="background-color: #FF69B4; width: 100%; height: 5px; margin-bottom: 2px;"></div> <div style="background-color: #FFDAB9; width: 100%; height: 5px; margin-bottom: 2px;"></div> <div style="background-color: #FFB6C1; width: 100%; height: 5px;"></div> 1,150 890 600 (250)	<div style="border: 1px solid black; border-radius: 50%; width: 15px; height: 15px; display: flex; align-items: center; justify-content: center;"> <span style="font-size: 10px; font-weight: bold;">R</span> </div> R1	Opening angle: 1.5°; optical axis adjusted before delivery	E32-A03
		59					Opening angle: 1.5°; with mounting flange; optical axis adjusted before delivery	E32-A03-1
		44			<div style="background-color: #008080; width: 100%; height: 5px; margin-bottom: 2px;"></div> <div style="background-color: #FF69B4; width: 100%; height: 5px; margin-bottom: 2px;"></div> <div style="background-color: #FFDAB9; width: 100%; height: 5px; margin-bottom: 2px;"></div> <div style="background-color: #FFB6C1; width: 100%; height: 5px;"></div> 1,750 1,300 870 (350)	R10	Long distance; opening angle: 4°	E32-T24S
		59			<div style="background-color: #008080; width: 100%; height: 5px; margin-bottom: 2px;"></div> <div style="background-color: #FF69B4; width: 100%; height: 5px; margin-bottom: 2px;"></div> <div style="background-color: #FFDAB9; width: 100%; height: 5px; margin-bottom: 2px;"></div> <div style="background-color: #FFB6C1; width: 100%; height: 5px;"></div> 460 340 225 (100)		Ultraslim (t = 2 mm); opening angle: 3°; optical axis adjusted before delivery	E32-A04
		59			<div style="background-color: #008080; width: 100%; height: 5px; margin-bottom: 2px;"></div> <div style="background-color: #FF69B4; width: 100%; height: 5px; margin-bottom: 2px;"></div> <div style="background-color: #FFDAB9; width: 100%; height: 5px; margin-bottom: 2px;"></div> <div style="background-color: #FFB6C1; width: 100%; height: 5px;"></div> 460 340 225 (100)		Ultraslim (t = 2 mm); opening angle: 3°; with mounting flange; optical axis adjusted before delivery	E32-A04-1

\*1. The values for the minimum sensing object are representative values that indicate values obtained in standard mode with the sensing distance and sensitivity set to optimum values.

\*2.  Indicates models that allow free cutting.

\*3. For continuous operation, use the products within a temperature range of -40°C to 130°C.

\*4. The maximum temperature that can be withstood varies with the location. Refer to dimensions diagrams for details.





\*5. These values are based on the assumption that there are no repeated sudden changes in temperature.

R Flexible 
 B Break-resistant 
 U Fluoresin coating

Accessories

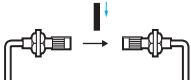
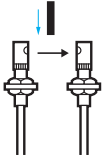
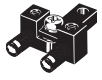
Lens Units

\*When used in combination with the E3X-DA-S Amplifier Unit (general-purpose).



Type	Appearance	Dimensions page	Applicable Fiber Units	Sensing distance (mm)				Standard object (min. sensing object) (mm) *1	Features	Model number
				High-resolution mode	Standard mode	High-speed mode	Super-high-speed mode			
Through-beam Lens Units	 <p>Long-distance Lens Units</p>	60	E32-T11L	4,000*2	3,200	2,100	840	4 dia. (0.1 dia.)	Long-distance sensing; opening angle: 5° to 40° (heat resistant up to 200°C)	E39-F1
			E32-TC200	4,000*2	4,000*2	2,600	1,500			
			E32-T11R	4,000*2	3,700	2,400	970			
			E32-T11	4,000*2	3,600	2,300	930			
			E32-T11U	4,000*2	3,600	2,300	930			
			E32-T81R-S	2,650	2,100	1,300	520			
			E32-T61-S	4,000*2	3,400	2,200	900			
	 <p>Side-view Units</p>	60	E32-T11L	910	800	500	180	3 dia. (0.1 dia.)	Side-view, space-saving (heat resistant up to 200°C)	E39-F2
			E32-TC200	840	700	450	160			
			E32-T11R	520	400	250	100			
			E32-T11	820	660	430	160			
			E32-T11U	820	660	430	160			
			E32-T81R-S	360	280	180	70			
			E32-T61-S	600	450	300	120			
	 <p>Reflection Units</p>	60	E32-T11L E32-TC200 E32-T11R E32-T11 E32-T11U E32-T81R-S E32-T61-S	---				---	Long distance reflection (heat resistant up to 200°C)	E39-F3
	Reflective Lens Units	 <p>Small-spot Lens Units</p>	60	E32-C42	Spot diameter variable in the range 0.1 to 0.6 mm at distances in the range 6 to 15 mm				Small spot (variable)	E39-F3A
				E32-D32	Spot diameter variable in the range 0.5 to 1 mm at distances in the range 6 to 15 mm					
			60	E32-C41	0.1-dia. spot at a distance of 7 mm				Small spot	E39-F3A-5
E32-C31				0.5-dia. spot at a distance of 7 mm						
		60	E32-C41	0.2-dia. spot at a distance of 17 mm				Long distance, small spot	E39-F3B	
			E32-C31	0.5-dia. spot at a distance of 17 mm						
		60	E32-C31 E32-C41	Spot diameter of 4 mm max. at distances in the range 0 to 20 mm				Long-distance sensing, parallel light	E39-F3C	

\*1. The values for the minimum sensing object are representative values that indicate values obtained in standard mode with the sensing distance and sensitivity set to optimum values.

\*2. The optical fiber is 2 m long on each side, so the sensing distance is 4,000 mm.







Accessories

Protective Spiral Tube

Appearance	Dimensions page	Application	Applicable Fiber Units	Tube length	Model number
	61	Fiber protection	M3-screw models E32-D21/E32-D21R E32-DC200E E32-DC200F□ E32-C31	500 mm	E39-F32A5
				1 m	E39-F32A
			M3-screw models E32-T21□ (Except the E32-T21R.) E32-TC200E E32-TC200F□	500 mm	E39-F32B5
				1 m	E39-F32B
	61		M4-screw models E32-T11□ (except the E32-T11N Right-angle Model) E32-TC200 E32-TC200B□ E32-T51 E32-D21L/E32-D21B	500 mm	E39-F32C5
				1 m	E39-F32C
	61		M6-screw models E32-D11□ (except the E32-D11N Right-angle Model) E32-DC200 E32-DC200B E32-CC200□ E32-D51	500 mm	E39-F32D5
				1 m	E39-F32D

Note: Before using a Protective Spiral Tube, remove the protective tube that protects the area between the head and the optical fiber provided with some models. The Lens Unit and Spiral Tube cannot be used at the same time.

Other Accessories

Appearance	Dimensions page	Application	Name	Applicable Fiber Units	Remarks	Model number
	62	Used to cut the fiber.	Cutter	Fiber Units that allow free cutting	Provided with applicable Fiber Units.	E39-F4
	62	Attachments for inserting thin fibers into Amplifier Units	Thin-fiber Attachments	Fiber Units that allow free cutting and have a 1.0-dia. sheath	<ul style="list-style-type: none"> <li>• 2 per set</li> <li>• Provided with applicable Fiber Units.</li> </ul>	E39-F9
	62	Used to extend fibers.		Fiber Units that allow free cutting and have a 2.2-dia. sheath	---	E39-F10
	62	Easy-to-use, one-touch relay connectors	Fiber Connectors	Fiber Units that allow free cutting	E39-F13: Used for Fiber Units with a 2.2-dia. sheath. E39-F14: Used for Fiber Units with a 1.0-dia. sheath. E39-F15: Used to connect Fiber Units with different sheath diameters, 1.0 mm and 2.2 mm.	E39-F13 E39-F14 E39-F15
	62	Used to bends in sleeves.	Sleeve Bender	E32-TC200B(4) E32-TC200F(4) E32-DC200F(4)	---	E39-F11
	62	Used to secure the 3.5-dia. Fiber Head	Mounting Bracket	E32-T24S E32-A03	Provided with applicable Fiber Units.	E39-L83

Ratings/Characteristics

Standard models

Models	Ambient operating temperature range	Ambient humidity range	Fiber core material (sheath material)	Permissible bending radius	Tightening force (N·m)	Pulling force (N)	IEC standard degree of protection
E32-D11	-40 to +70°C	35% to 85%	Plastic (PVC coating)	R4	0.98	29.4	IP67
E32-D11N			Plastic (PVC coating)	R1	0.98	29.4	IP67
E32-D11R			Plastic (PVC coating)	R1	0.98	29.4	IP67
E32-D11U			Plastic (fluororesin coating)	R4	0.98	29.4	IP67
E32-D12			Plastic (polyethylene coating)	R25	0.29	29.4	IP67
E32-D12R			Plastic (PVC coating)	R1	0.29	29.4	IP67
E32-D14L			Plastic (polyethylene coating)	R25	0.98	29.4	IP67
E32-D14LR			Plastic (PVC coating)	R1	0.98	29.4	IP67
E32-D15X			Plastic (polyethylene coating)	R25	0.15	29.4	IP67
E32-D15XB			Plastic (PVC coating)	R4	0.15	29.4	IP67
E32-D15XR			Plastic (PVC coating)	R1	0.15	29.4	IP67
E32-D15Y			Plastic (polyethylene coating)	R25	0.15	29.4	IP40
E32-D15YR			Plastic (PVC coating)	R1	0.15	29.4	IP40
E32-D15Z			Plastic (polyethylene coating)	R25	0.15	29.4	IP40
E32-D15ZR			Plastic (PVC coating)	R1	0.15	29.4	IP40
E32-D21			Plastic (PVC coating)	R4	0.78	9.8	IP67
E32-D211			Plastic (polyethylene coating)	R10	0.78	9.8	IP67
E32-D211R			Plastic (polyethylene coating)	R1	0.78	9.8	IP67
E32-D21B			Plastic (PVC coating)	R4	0.78	9.8	IP67
E32-D21R			Plastic (polyethylene coating)	R1	0.78	9.8	IP67
E32-D22			Plastic (polyethylene coating)	R10	0.29	9.8	IP67
E32-D221B			Plastic (PVC coating)	R4	0.29	9.8	IP67
E32-D22B			Plastic (PVC coating)	R4	0.20	9.8	IP67
E32-D22R			Plastic (polyethylene coating)	R1	0.29	9.8	IP67
E32-D24			Plastic (polyethylene coating)	R10	0.29	9.8	IP67
E32-D24R			Plastic (polyethylene coating)	R1	0.29	9.8	IP67
E32-D25X			Plastic (polyethylene coating)	R10	0.15	9.8	IP67
E32-D25XB			Plastic (PVC coating)	R4	0.15	9.8	IP67
E32-D25XR			Plastic (polyethylene coating)	R1	0.15	9.8	IP67
E32-D25Y			Plastic (polyethylene coating)	R10	0.15	9.8	IP40
E32-D25YR			Plastic (polyethylene coating)	R1	0.15	9.8	IP40
E32-D25Z			Plastic (polyethylene coating)	R10	0.15	9.8	IP40
E32-D25ZR			Plastic (polyethylene coating)	R1	0.15	9.8	IP40
E32-DC200			Plastic (polyethylene coating)	R25	0.98	29.4	IP67
E32-DC200B(B4)			Plastic (polyethylene coating)	R25	0.98	29.4	IP67
E32-DC200BR(B4R)			Plastic (PVC coating)	R1	0.98	29.4	IP67
E32-DC200E			Plastic (polyethylene coating)	R10	0.78	9.8	IP67
E32-DC200F(F4)			Plastic (polyethylene coating)	R10	0.78	9.8	IP67
E32-DC200FR(F4R)			Plastic (polyethylene coating)	R1	0.78	9.8	IP67
E32-T11			Plastic (PVC coating)	R4	0.78	29.4	IP67
E32-T11N			Plastic (PVC coating)	R1	0.78	29.4	IP67
E32-T11R			Plastic (PVC coating)	R1	0.78	29.4	IP67
E32-T11U			Plastic (fluororesin coating)	R4	0.78	29.4	IP67
E32-T12			Plastic (polyethylene coating)	R25	0.29	29.4	IP67
E32-T12B			Plastic (PVC coating)	R4	0.29	29.4	IP67
E32-T12R			Plastic (PVC coating)	R1	0.29	29.4	IP67
E32-T14L			Plastic (polyethylene coating)	R25	0.29	29.4	IP67
E32-T14LR			Plastic (PVC coating)	R1	0.29	29.4	IP67
E32-T15X			Plastic (polyethylene coating)	R25	0.15	29.4	IP67
E32-T15XB			Plastic (PVC coating)	R4	0.15	29.4	IP67
E32-T15XR			Plastic (PVC coating)	R1	0.15	29.4	IP67
E32-T15Y			Plastic (polyethylene coating)	R25	0.15	29.4	IP40
E32-T15YR			Plastic (PVC coating)	R1	0.15	29.4	IP40
E32-T15Z			Plastic (polyethylene coating)	R25	0.15	29.4	IP40
E32-T15ZR	Plastic (PVC coating)	R1	0.15	29.4	IP40		
E32-T21	Plastic (PVC coating)	R4	0.78	9.8	IP67		
E32-T21R	Plastic (polyethylene coating)	R1	0.78	29.4	IP67		
E32-T22	Plastic (polyethylene coating)	R10	0.29	9.8	IP67		
E32-T221B	Plastic (PVC coating)	R4	0.29	9.8	IP67		
E32-T222	Plastic (polyethylene coating)	R10	0.20	9.8	IP67		
E32-T222R	Plastic (polyethylene coating)	R1	0.20	9.8	IP67		
E32-T22B	Plastic (PVC coating)	R4	0.20	9.8	IP67		
E32-T22R	Plastic (polyethylene coating)	R1	0.29	9.8	IP67		

Standard models (continued)

Models	Ambient operating temperature range	Ambient humidity range	Fiber core material (sheath material)	Permissible bending radius	Tightening force (N·m)	Pulling force (N)	IEC standard degree of protection
E32-T24	-40 to +70°C	35% to 85%	Plastic (polyethylene coating)	R10	0.29	9.8	IP67
E32-T24R			Plastic (polyethylene coating)	R1	0.29	9.8	IP67
E32-T25X			Plastic (polyethylene coating)	R10	0.15	9.8	IP67
E32-T25XB			Plastic (PVC coating)	R4	0.15	9.8	IP67
E32-T25XR			Plastic (polyethylene coating)	R1	0.15	9.8	IP67
E32-T25Y			Plastic (polyethylene coating)	R10	0.15	9.8	IP40
E32-T25YR			Plastic (polyethylene coating)	R1	0.15	9.8	IP40
E32-T25Z			Plastic (polyethylene coating)	R10	0.15	9.8	IP40
E32-T25ZR			Plastic (polyethylene coating)	R1	0.15	9.8	IP40
E32-TC200			Plastic (polyethylene coating)	R25	0.78	29.4	IP67
E32-TC200A			Plastic (polyethylene coating)	R25	0.78	29.4	IP67
E32-TC200B(B4)			Plastic (polyethylene coating)	R25	0.78	29.4	IP67
E32-TC200BR(B4R)			Plastic (PVC coating)	R1	0.78	29.4	IP67
E32-TC200E			Plastic (polyethylene coating)	R10	0.78	9.8	IP67
E32-TC200F(F4)			Plastic (polyethylene coating)	R10	0.78	9.8	IP67
E32-TC200FR(F4R)			Plastic (polyethylene coating)	R1	0.78	9.8	IP67

Special-beam models

Models	Ambient operating temperature range	Ambient humidity range	Fiber core material (sheath material)	Permissible bending radius	Tightening force (N·m)	Pulling force (N)	IEC standard degree of protection
E32-A10	-40 to +70°C	35% to 85%	Plastic (polyethylene coating)	R25	0.53	29.4	IP30
E32-C11N	-40 to +70°C		Plastic (combination of PVC and polyethylene)	R4	0.98	29.4	IP67
E32-C31	-40 to +70°C		Plastic (polyethylene coating)	R25	0.78	9.8	IP67
E32-C31N	-40 to +70°C		Plastic (combination of PVC and polyethylene)	R4	0.29	9.8	IP67
E32-C41	-40 to +70°C		Plastic (polyethylene coating)	R25	0.78	9.8	IP67
E32-C42	-40 to +70°C		Plastic (polyethylene coating)	R25	0.29	9.8	IP67
E32-CC200	-40 to +70°C		Plastic (polyethylene coating)	R25	0.98	29.4	IP67
E32-CC200R	-40 to +70°C		Plastic (polyethylene coating)	R4	0.98	29.4	IP67
E32-D11L	-40 to +70°C		Plastic (polyethylene coating)	R25	0.98	29.4	IP67
E32-D16	-40 to +70°C		Plastic (PVC coating)	R4	0.53	29.4	IP40
E32-D21L	-40 to +70°C		Plastic (polyethylene coating)	R10	0.78	9.8	IP67
E32-D22L	-40 to +70°C		Plastic (polyethylene coating)	R10	0.29	9.8	IP67
E32-D32	-40 to +70°C		Plastic (polyethylene coating)	R25	0.29	9.8	IP67
E32-D32L	-40 to +70°C		Plastic (polyethylene coating)	R25	0.29	29.4	IP67
E32-D33	-40 to +70°C		Plastic (polyethylene coating)	R4	0.29	9.8	IP67
E32-D331	-40 to +70°C		Plastic (polyethylene coating)	R4	0.29	9.8	IP67
E32-D36P1	-40 to +70°C		Plastic (polyethylene coating)	R4	0.78	29.4	IP67
E32-L24L	-40 to +105°C		Plastic (polyethylene coating)	R10	0.29	9.8	IP50
E32-L24S	-40 to +70°C		Plastic (polyethylene coating)	R10	0.29	9.8	IP40
E32-L25	-40 to +70°C		Plastic (polyethylene coating)	R25	0.29	19.6	IP50
E32-L25A	-40 to +70°C		Plastic (polyethylene coating)	R25	0.29	19.6	IP50
E32-L25L	-40 to +105°C		Plastic (polyethylene coating)	R10	0.29	9.8	IP50
E32-L64	-40 to +300°C		Glass (SUS spiral coating)	R25	0.54	9.8	IP50
E32-L86	-40 to +200°C		Glass (SUS spiral coating)	R25	0.54	9.8	IP40
E32-M21	-40 to +70°C		Plastic (PVC coating)	R25	0.49. 0.78*	9.8	IP50
E32-R16	-25 to +55°C		Plastic (polyethylene coating)	R25	0.54	29.4	IP66
E32-R21	-40 to +70°C		Plastic (polyethylene coating)	R10	0.39	9.8	IP67
E32-T11L	-40 to +70°C		Plastic (polyethylene coating)	R25	0.78	29.4	IP67
E32-T12L	-40 to +70°C		Plastic (polyethylene coating)	R25	0.29	29.4	IP67
E32-T14	-40 to +70°C		Plastic (polyethylene coating)	R25	0.49	29.4	IP67
E32-T16	-40 to +70°C		Plastic (polyethylene coating)	R25	0.49	29.4	IP67
E32-T16J	-40 to +70°C		Plastic (PVC coating)	R10	0.29	29.4	IP50
E32-T16JR	-40 to +70°C		Plastic (PVC coating)	R1	0.29	29.4	IP50
E32-T16P	-40 to +70°C		Plastic (PVC coating)	R10	0.29	29.4	IP50
E32-T16PR	-40 to +70°C		Plastic (PVC coating)	R1	0.29	29.4	IP50
E32-T16W	-25 to +55°C		Plastic (PVC coating)	R10	0.29	9.8	IP50
E32-T16WR	-25 to +55°C		Plastic (PVC coating)	R1	0.29	9.8	IP50
E32-T17L	-40 to +70°C		Plastic (polyethylene coating)	R25	0.78	29.4	IP67
E32-T21L	-40 to +70°C		Plastic (polyethylene coating)	R10	0.78	9.8	IP67
E32-T223R	-40 to +70°C		Plastic (polyethylene coating)	R1	0.20	9.8	IP67
E32-T22L	-40 to +70°C		Plastic (polyethylene coating)	R10	0.29	9.8	IP67
E32-T22S	-40 to +70°C		Plastic (PVC coating)	R10	0.29	29.4	IP50
E32-T24S	-40 to +70°C		Plastic (PVC coating)	R10	0.29	29.4	IP50
E32-T333-S5	-40 to +70°C		Plastic (polyethylene coating)	R10	0.29	9.8	IP67
E32-T334-S5	-40 to +70°C		Plastic (polyethylene coating)	R10	0.29	9.8	IP67
E32-T33-S5	-40 to +70°C		Plastic (PVC coating)	R10	0.29	9.8	IP67

\*The strength depends on the section. Use 0.49 N·m max. to 5 mm from the tip and 0.78 N·m max. at a distance of more than 5 mm from the tip.

Environment-resistant models

Models	Ambient operating temperature range	Ambient humidity range	Fiber core material (sheath material)	Permissible bending radius	Tightening force (N·m)	Pulling force (N)	IEC standard degree of protection
E32-D12F	-40 to +70°C	35% to 85%	Plastic (fluororesin coating)	R40	0.78	29.4	IP67
E32-D14F	-40 to +70°C		Plastic (fluororesin coating)	R40	0.78	29.4	IP67
E32-D51	-40 to +150°C		Plastic (fluororesin coating)	R35	0.98	29.4	IP67
E32-D61	-60 to +350°C		Glass (SUS spiral coating)	R25	0.98	29.4	IP67
E32-D61-S	-60 to +350°C		Glass (SUS spiral coating)	R25	0.98	29.4	IP67
E32-D73	-40 to +400°C		Glass (SUS spiral coating)	R25	0.78	29.4	IP67
E32-D73-S	-40 to +400°C		Glass (SUS spiral coating)	R25	0.78	29.4	IP67
E32-D81R	-40 to +200°C		Glass (fluororesin coating)	R10	0.78	9.8	IP67
E32-D81R-S	-40 to +200°C		Glass (fluororesin coating)	R10	0.78	9.8	IP67
E32-T11F	-40 to +70°C		Plastic (fluororesin coating)	R4	0.29	29.4	IP67
E32-T12F	-40 to +70°C		Plastic (fluororesin coating)	R40	0.78	29.4	IP67
E32-T14F	-40 to +70°C		Plastic (fluororesin coating)	R40	0.78	29.4	IP67
E32-T51	-40 to +150°C		Plastic (fluororesin coating)	R35	0.78	29.4	IP67
E32-T51F	-40 to +150°C		Plastic (fluororesin coating)	R40	0.78	29.4	IP67
E32-T51V	-25 to +120°C		Glass (fluororesin coating)	R30	0.29	29.4	---
E32-T54	-40 to +150°C		Plastic (fluororesin coating)	R35	0.29	29.4	IP67
E32-T54V	-25 to +120°C		Glass (fluororesin coating)	R30	0.29	29.4	---
E32-T61-S	-60 to +350°C		Glass (SUS spiral coating)	R25	0.78	29.4	IP67
E32-T81F-S	-40 to +200°C		Glass (fluororesin coating)	R10	0.78	9.8	IP67
E32-T81R-S	-40 to +200°C		Glass (fluororesin coating)	R10	0.78	9.8	IP67
E32-T84S-S	-40 to +200°C		Glass (fluororesin coating)	R25	0.29	9.8	IP67
E32-T84SV	-25 to +200°C		Glass (SUS spiral coating)	R25	0.29	29.4	---

Application-corresponding models

Models	Ambient operating temperature range	Ambient humidity range	Fiber core material (sheath material)	Permissible bending radius	Tightening force (N·m)	Pulling force (N)	IEC standard degree of protection
E32-A01	-40 to +70°C	35% to 85%	Plastic (fluororesin coating)	R4	---	9.8	IP50
E32-A02	-40 to +70°C		Plastic (fluororesin coating)	R4	---	9.8	IP50
E32-A03	-40 to +70°C		Plastic (polyethylene coating)	R1	0.29	9.8	IP50
E32-A03-1	-40 to +70°C		Plastic (polyethylene coating)	R10	0.29	9.8	IP50
E32-A04	-40 to +70°C		Plastic (polyethylene coating)	R10	0.29	9.8	IP50
E32-A04-1	-40 to +70°C		Plastic (polyethylene coating)	R10	0.29	9.8	IP50
E32-A07E1(E2)	-40 to +70°C		Plastic (polyethylene coating)	R25	0.53	9.8	IP40
E32-A08	-40 to +70°C		Plastic (polyethylene coating)	R25	0.53	9.8	IP40
E32-A08H2	-40 to +300°C		Glass (SUS spiral coating)	R25	0.53	29.4	IP30
E32-A09	-40 to +70°C		Plastic (polyethylene coating)	R25	0.53	9.8	IP40
E32-A09H	-40 to +150°C		Plastic (fluororesin coating)	R35	0.53	9.8	IP40
E32-A09H2	-40 to +300°C		Glass (SUS spiral coating)	R25	0.53	9.8	IP40
E32-D36T	-40 to +70°C		Plastic (polyethylene coating)	R4	---	29.4	IP67
E32-D82F1	-40 to +200°C		Tip: Glass and fluororesin coating Amplifier insert: Plastic (fluororesin coating)	R40	0.29	29.4	IP68
E32-D82F2	-40 to +200°C		(Fluororesin coating)	R40	0.29	29.4	IP68
E32-G14	-40 to +70°C		Plastic (polyethylene coating)	R25	0.49	29.4	IP67
E32-L16-N	-40 to +70°C		Plastic (polyethylene coating)	R25	0.29	29.4	IP40
E32-L25T	-40 to +70°C		Plastic (polyethylene coating)	R10	---	9.8	IP50
E32-L66	-40 to +300°C		Glass (SUS spiral coating)	R25	0.53	9.8	IP40
E32-T14	-40 to +70°C		Plastic (polyethylene coating)	R25	0.49	29.4	IP67

Dimensions

**Through-beam Fiber Units** Through-beam models consist of two parts: an emitter and a receiver.

R Flexible 
 B Break-resistant 
 U Fluororesin coating 
 R1 Standard 
 Free-cut Cutting free (Cutter provided)

Standard Standard/Flexible Models

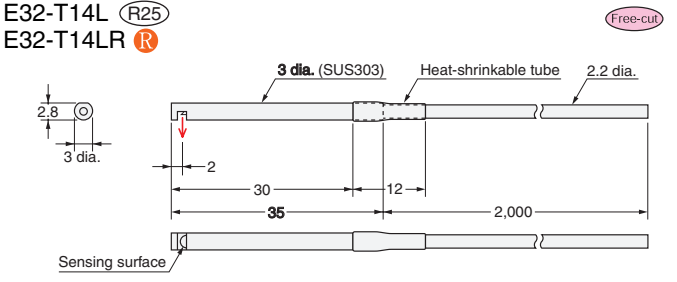
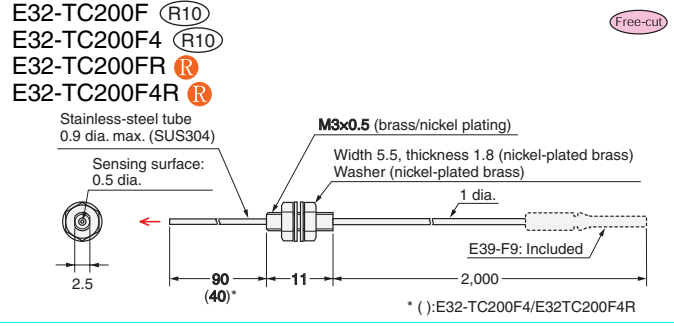
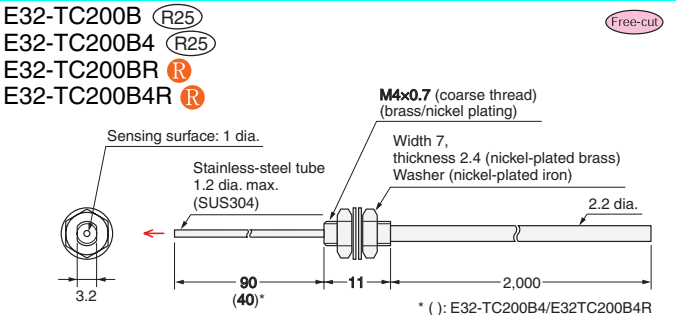
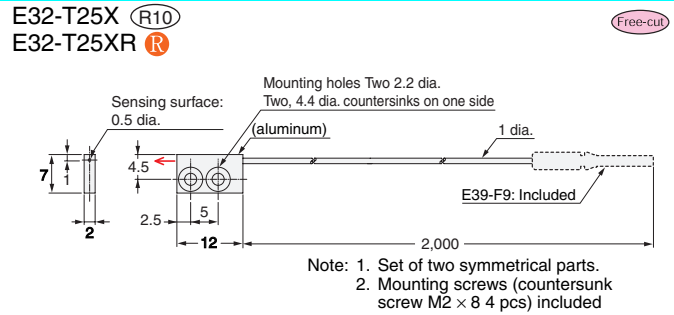
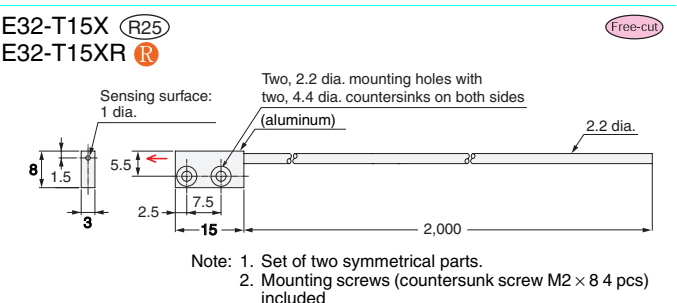
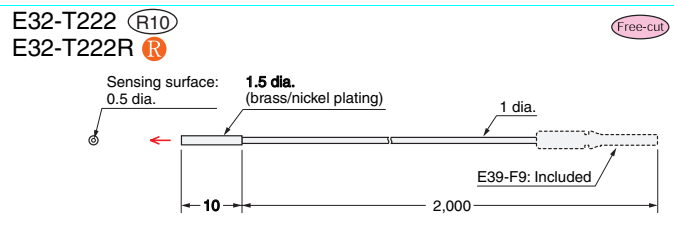
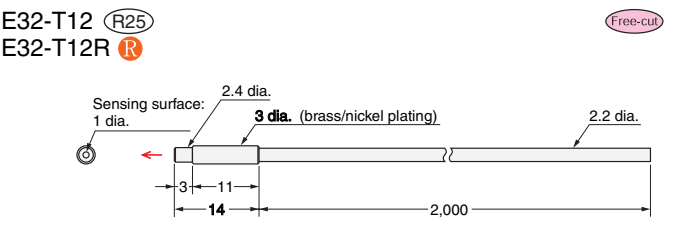
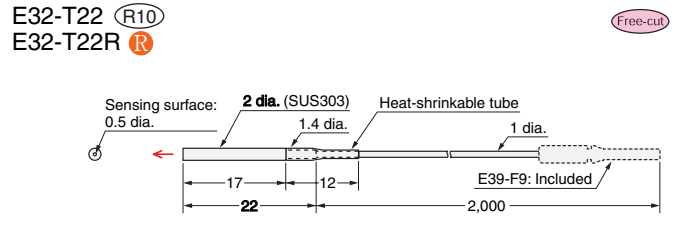
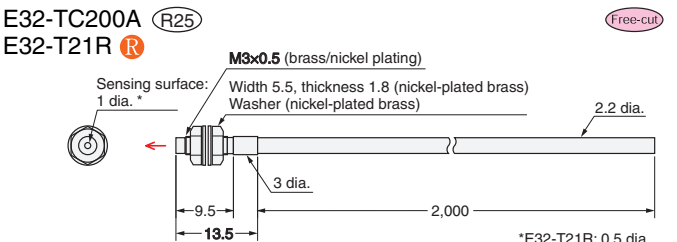
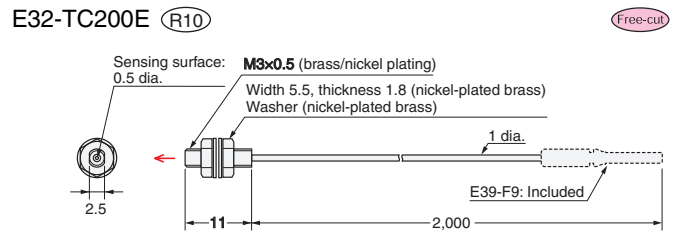
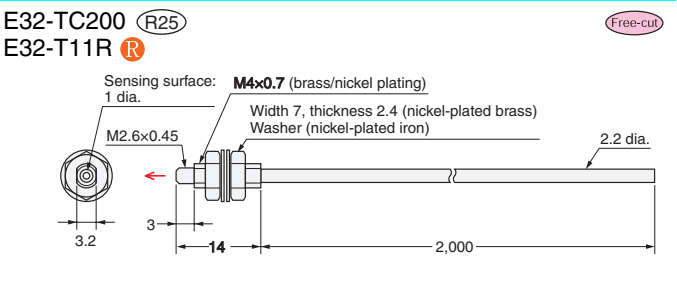
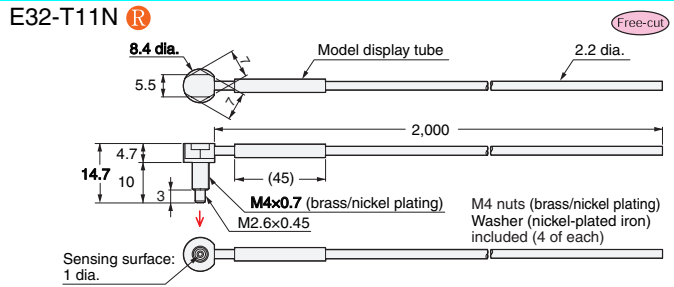



**Through-beam Fiber Units** Through-beam models consist of two parts: an emitter and a receiver.

**R** Flexible **B** Break-resistant **U** Fluororesin coating **R□** Standard  
**Free-cut** Cutting free (Cutter provided)

**Standard** Standard/Flexible Models

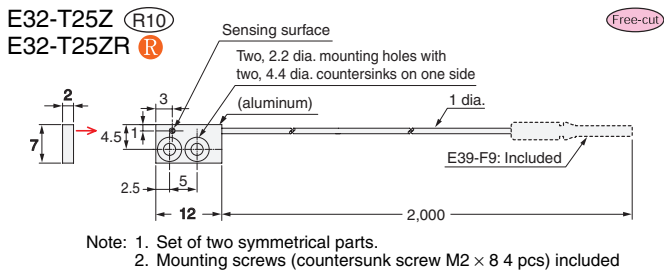
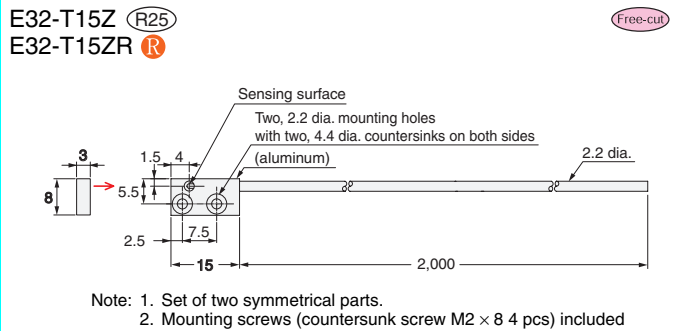
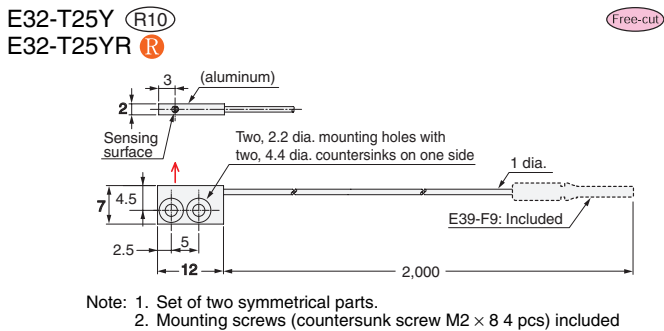
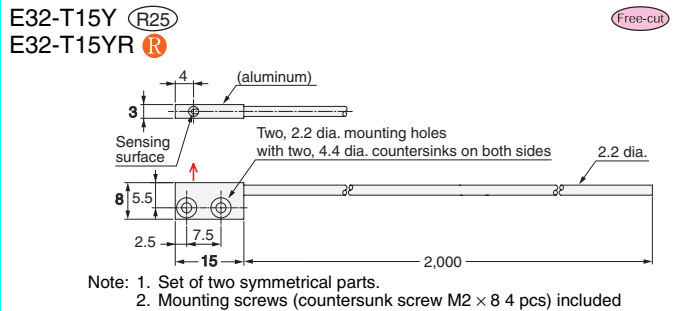
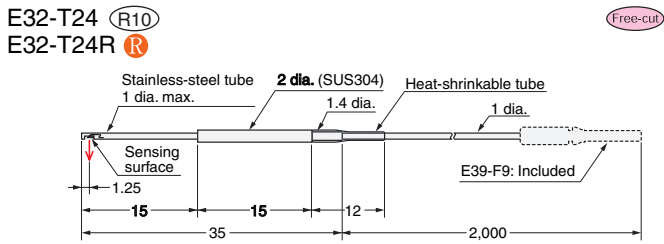

**Mounting hole dimensions (recommended)**

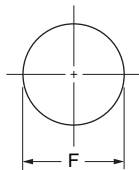

**<Screw-mounting Model>** (Unit:mm)

Outer diameter of fiber unit	M3	M4	M6	M14
F dimensions	3 <sup>+0.5</sup> <sub>0</sub> dia.	4 <sup>+0.5</sup> <sub>0</sub> dia.	6 <sup>+0.5</sup> <sub>0</sub> dia.	14 <sup>+1</sup> <sub>0</sub> dia.

Example: Head size of E32-TC200 is M4. Open the mounting holes with 4 to 4.5 dia.

**<Cylindrical Model>** (Unit:mm)

Outer diameter of fiber unit	1 dia.	1.5 dia.	2 dia.	3 dia.
F dimensions	1.2 <sup>+0.2</sup> <sub>0</sub> dia.	1.7 <sup>+0.2</sup> <sub>0</sub> dia.	2.2 <sup>+0.2</sup> <sub>0</sub> dia.	3.2 <sup>+0.2</sup> <sub>0</sub> dia.
Outer diameter of fiber unit	3.5 dia.	4 dia.	5 dia.	6 dia.
F dimensions	4 <sup>+0.5</sup> <sub>0</sub> dia.	4.5 <sup>+0.5</sup> <sub>0</sub> dia.	5.5 <sup>+0.5</sup> <sub>0</sub> dia.	6.5 <sup>+0.5</sup> <sub>0</sub> dia.

Example: Head size of E32-T22 is 2 dia.. Open the mounting holes with 2.2 to 2.4 dia.

**Minimum bending radius**

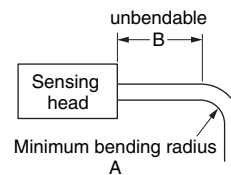

**R** Flexible **B** Break-resistant **U** Fluororesin coating **R□** Standard (Unit:mm)

Type	A Minimum bending radius	B unbendable
(except E32-C11N, E32-C31N and E32-CC200)	1	0
(E32-C11N, E32-C31N, E32-CC200R)	4	0
<b>B</b> <b>U</b> <b>R4</b>	4	10
<b>R10</b>	10	10
<b>R25</b>	25	10
<b>R30</b>	30	10
<b>R35</b>	35	10
<b>R40</b>	40	10

Standard Models Break-resistant/Coated Models

R Flexible 
 B Break-resistant 
 U Fluororesin coating 
 R Standard  
Free-cut Cutting free (Cutter provided)

E32-T11 B  
E32-T11U U

Free-cut

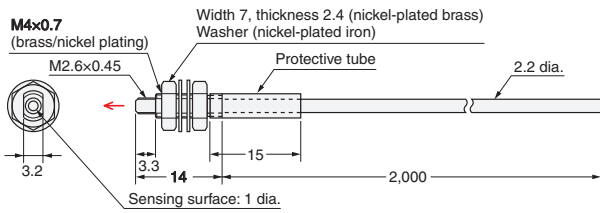

E32-T21 B

Free-cut

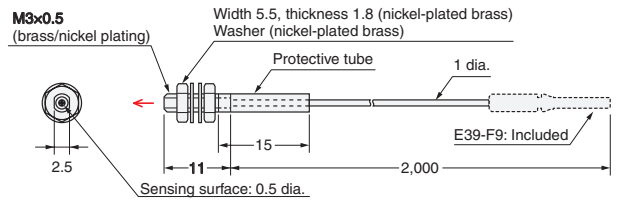

E32-T12B B

Free-cut

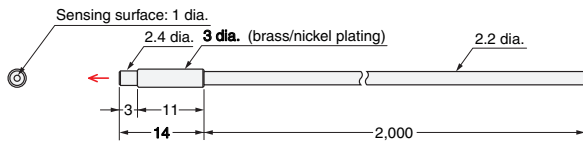

E32-T221B B

Free-cut

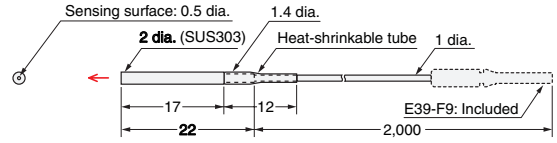

E32-T22B B

Free-cut

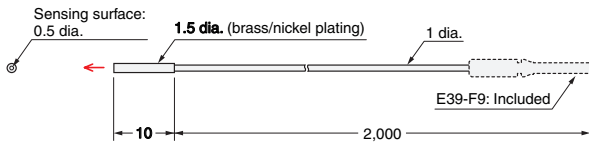

E32-T15XB B

Free-cut

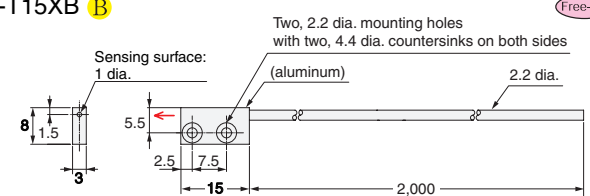

Note: 1. Set of two symmetrical parts.  
2. Mounting screws (countersunk screw M2 x 8 4 pcs) included

E32-T25XB B

Free-cut

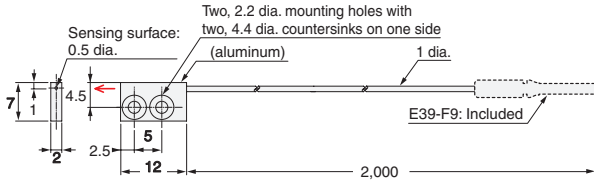

Note: 1. Set of two symmetrical parts.  
2. Mounting screws (countersunk screw M2 x 8 4 pcs) included

**Through-beam Fiber Units** Through-beam models consist of two parts: an emitter and a receiver.

R Flexible 
 B Break-resistant 
 U Fluororesin coating 
 R□ Standard  
Free-cut Cutting free (Cutter provided)

**Special-beam Models** Long-distance/High-power Models

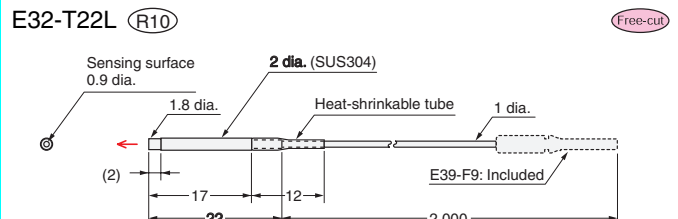
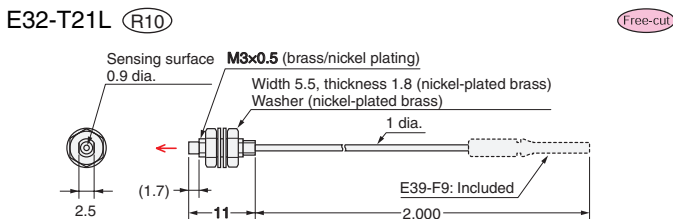
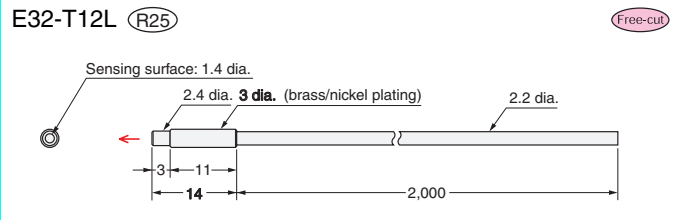
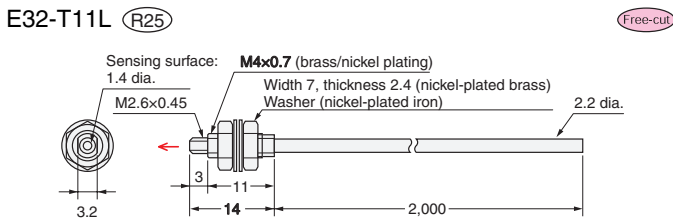
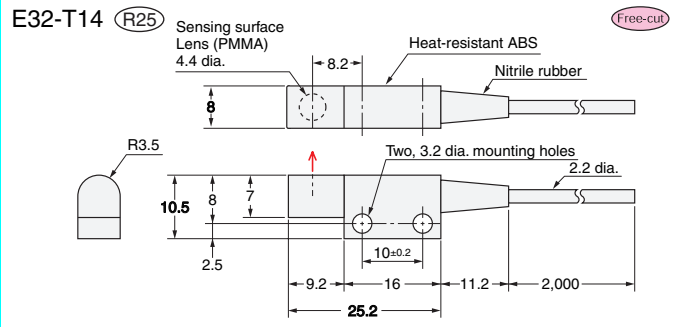
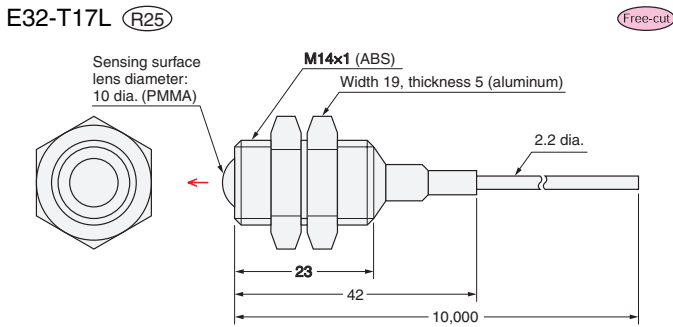

**Mounting hole dimensions (recommended)**

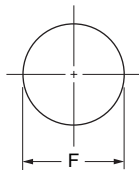

**<Screw-mounting Model>**

(Unit:mm)

Outer diameter of fiber unit	M3	M4	M6	M14
F dimensions	3 <sup>+0.5</sup> <sub>0</sub> dia.	4 <sup>+0.5</sup> <sub>0</sub> dia.	6 <sup>+0.5</sup> <sub>0</sub> dia.	14 <sup>+1</sup> <sub>0</sub> dia.

Example: Head size of E32-TC200 is M4. Open the mounting holes with 4 to 4.5 dia.

**<Cylindrical Model>**

(Unit:mm)

Outer diameter of fiber unit	1 dia.	1.5 dia.	2 dia.	3 dia.
F dimensions	1.2 <sup>+0.2</sup> <sub>0</sub> dia.	1.7 <sup>+0.2</sup> <sub>0</sub> dia.	2.2 <sup>+0.2</sup> <sub>0</sub> dia.	3.2 <sup>+0.2</sup> <sub>0</sub> dia.
Outer diameter of fiber unit	3.5 dia.	4 dia.	5 dia.	6 dia.
F dimensions	4 <sup>+0.5</sup> <sub>0</sub> dia.	4.5 <sup>+0.5</sup> <sub>0</sub> dia.	5.5 <sup>+0.5</sup> <sub>0</sub> dia.	6.5 <sup>+0.5</sup> <sub>0</sub> dia.

Example: Head size of E32-T22 is 2 dia.. Open the mounting holes with 2.2 to 2.4 dia.

**Minimum bending radius**

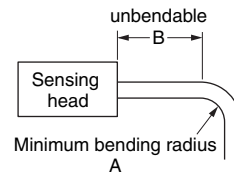

R Flexible 
 B Break-resistant 
 U Fluororesin coating 
 R□ Standard  
 (Unit:mm)

Type	A Minimum bending radius	B unbendable
<span style="border: 1px solid black; border-radius: 50%; padding: 2px;">R</span> (except E32-C11N, E32-C31N and E32-CC200)	1	0
<span style="border: 1px solid black; border-radius: 50%; padding: 2px;">R</span> (E32-C11N, E32-C31N, E32-CC200R)	4	0
<span style="border: 1px solid black; border-radius: 50%; padding: 2px;">B</span> <span style="border: 1px solid black; border-radius: 50%; padding: 2px;">U</span> <span style="border: 1px solid black; border-radius: 50%; padding: 2px;">R4</span>	4	10
<span style="border: 1px solid black; border-radius: 50%; padding: 2px;">R10</span>	10	10
<span style="border: 1px solid black; border-radius: 50%; padding: 2px;">R25</span>	25	10
<span style="border: 1px solid black; border-radius: 50%; padding: 2px;">R30</span>	30	10
<span style="border: 1px solid black; border-radius: 50%; padding: 2px;">R35</span>	35	10
<span style="border: 1px solid black; border-radius: 50%; padding: 2px;">R40</span>	40	10

**Through-beam Fiber Units** Through-beam models consist of two parts: an emitter and a receiver.

- R Flexible
- B Break-resistant
- U Fluororesin coating
- R10 Standard
- Free-cut Cutting free (Cutter provided)

**Special-beam Models Ultracompact/Thin-sleeve Models**

E32-T223R R

Free-cut

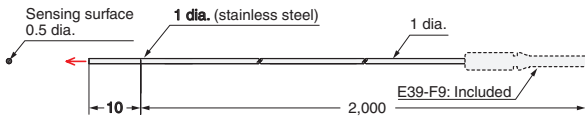

E32-T333-S5 R10

Free-cut

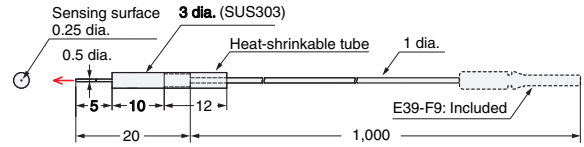

E32-T333-S5 R10

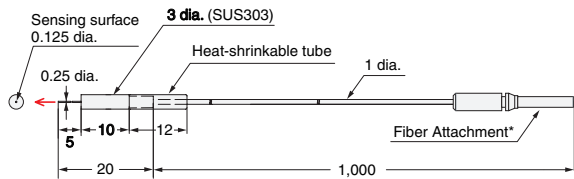

\*The Fiber Attachment is attached with adhesive and cannot be removed.

E32-T334-S5 R10

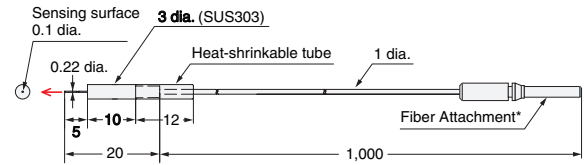

\*The Fiber Attachment is attached with adhesive and cannot be removed.

**Special-beam Models Fine-beam (narrow vision field) Models**

E32-T22S R10

Free-cut

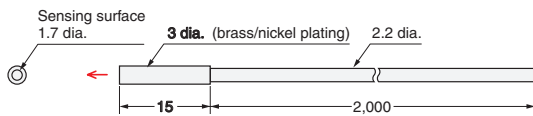

E32-T24S R10

Free-cut

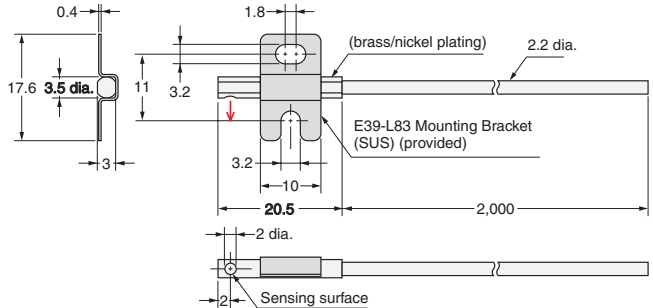

**Special-beam Models Area-sensing Models**

E32-T16W R10

Free-cut

E32-T16WR R

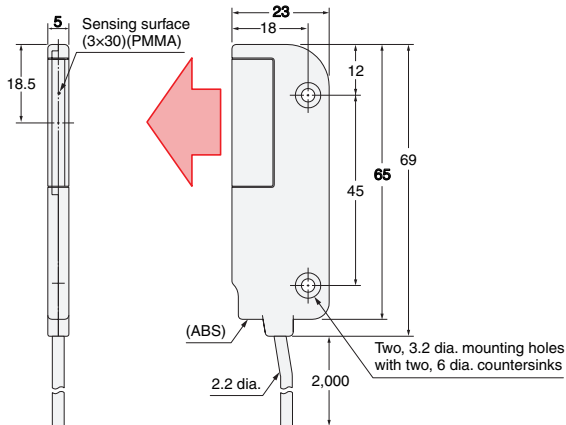

E32-M21 R25

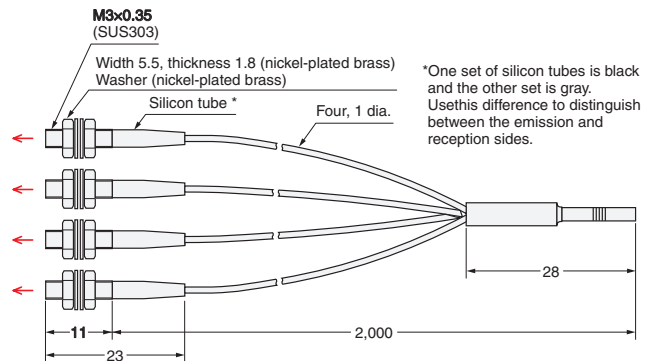

Special-beam Models Area-sensing Models

R Flexible 
 B Break-resistant 
 U Fluororesin coating 
 R□ Standard  
Free-cut Cutting free (Cutter provided)

E32-T16P R10  
E32-T16PR R

Free-cut

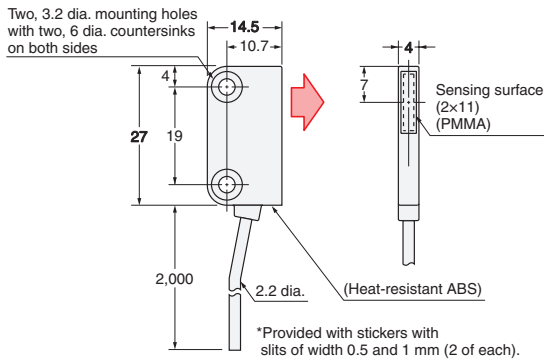

E32-T16 R25

Free-cut

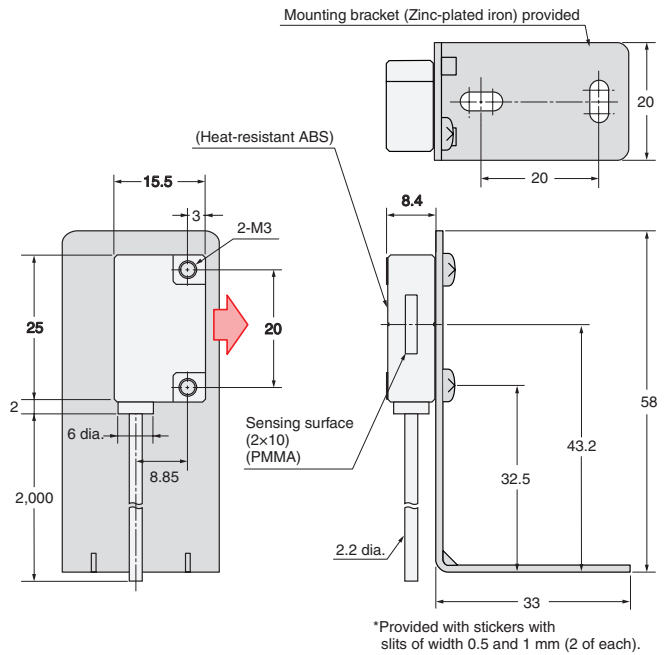

E32-T16J R10  
E32-T16JR R

Free-cut

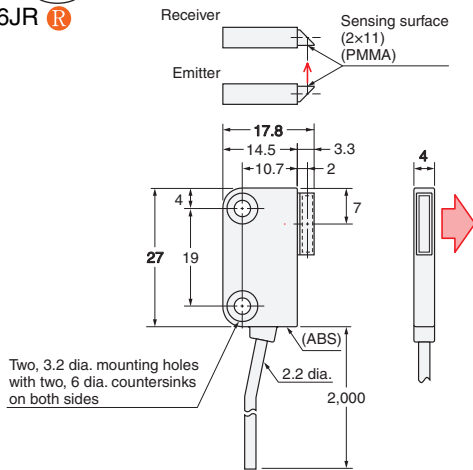

Mounting hole dimensions (recommended)



<Screw-mounting Model>

(Unit:mm)

Outer diameter of fiber unit	M3	M4	M6	M14
F dimensions	3 <sup>+0.5</sup> <sub>0</sub> dia.	4 <sup>+0.5</sup> <sub>0</sub> dia.	6 <sup>+0.5</sup> <sub>0</sub> dia.	14 <sup>+1</sup> <sub>0</sub> dia.

Example: Head size of E32-TC200 is M4. Open the mounting holes with 4 to 4.5 dia.

<Cylindrical Model>

(Unit:mm)

Outer diameter of fiber unit	1 dia.	1.5 dia.	2 dia.	3 dia.
F dimensions	1.2 <sup>+0.2</sup> <sub>0</sub> dia.	1.7 <sup>+0.2</sup> <sub>0</sub> dia.	2.2 <sup>+0.2</sup> <sub>0</sub> dia.	3.2 <sup>+0.2</sup> <sub>0</sub> dia.
Outer diameter of fiber unit	3.5 dia.	4 dia.	5 dia.	6 dia.
F dimensions	4 <sup>+0.5</sup> <sub>0</sub> dia.	4.5 <sup>+0.5</sup> <sub>0</sub> dia.	5.5 <sup>+0.5</sup> <sub>0</sub> dia.	6.5 <sup>+0.5</sup> <sub>0</sub> dia.

Example: Head size of E32-T22 is 2 dia.. Open the mounting holes with 2.2 to 2.4 dia.

Minimum bending radius

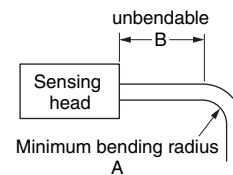

R Flexible 
 B Break-resistant 
 U Fluororesin coating 
 R□ Standard  
 (Unit:mm)

Type	A Minimum bending radius	B unbendable
(except E32-C11N, E32-C31N and E32-CC200)	1	0
(E32-C11N, E32-C31N, E32-CC200R)	4	0
<span style="border: 1px solid black; border-radius: 50%; padding: 2px;">B</span> <span style="border: 1px solid black; border-radius: 50%; padding: 2px;">U</span> <span style="border: 1px solid black; border-radius: 50%; padding: 2px;">R4</span>	4	10
<span style="border: 1px solid black; border-radius: 50%; padding: 2px;">R10</span>	10	10
<span style="border: 1px solid black; border-radius: 50%; padding: 2px;">R25</span>	25	10
<span style="border: 1px solid black; border-radius: 50%; padding: 2px;">R30</span>	30	10
<span style="border: 1px solid black; border-radius: 50%; padding: 2px;">R35</span>	35	10
<span style="border: 1px solid black; border-radius: 50%; padding: 2px;">R40</span>	40	10

**Through-beam Fiber Units** Through-beam models consist of two parts: an emitter and a receiver.

**R** Flexible **B** Break-resistant **U** Fluororesin coating **R□** Standard  
**Free-cut** Cutting free (Cutter provided)

**Environment-resistant Models** **Heat-resistant Models**

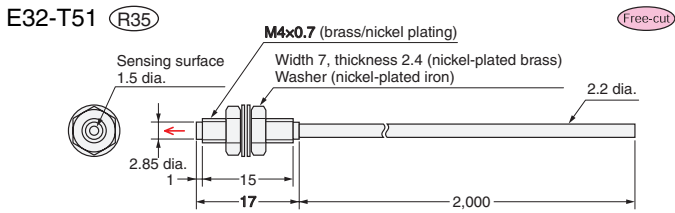

Note: The maximum allowable temperature is 150°C. The maximum allowable temperature for continuous operation is 130°C.

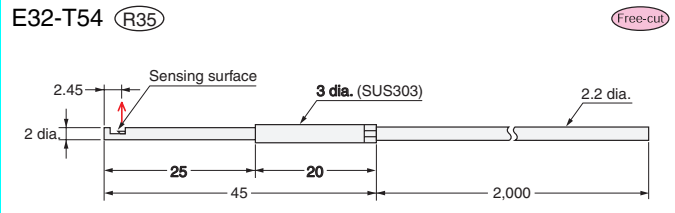

Note: The maximum allowable temperature is 150°C. The maximum allowable temperature for continuous operation is 130°C.

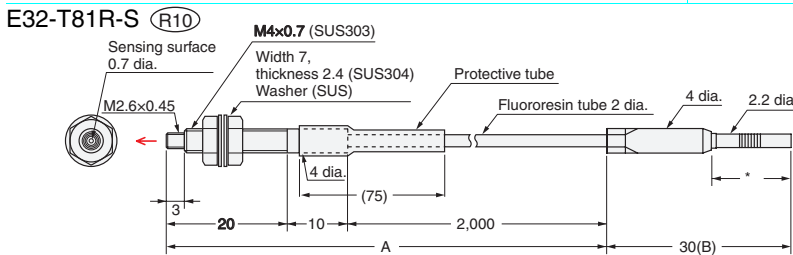

Note: The maximum allowable temperatures for sections A and B are 200°C and 110°C, respectively. The section inserted into the Amplifier Unit (indicated by \*), however, must stay within the Amplifier Unit's operating temperature range.

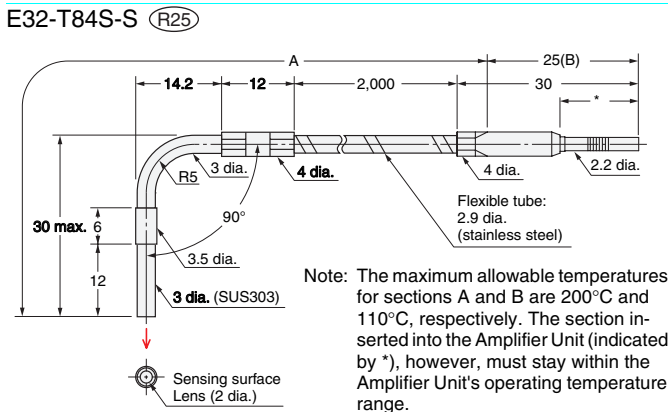

Note: The maximum allowable temperatures for sections A and B are 200°C and 110°C, respectively. The section inserted into the Amplifier Unit (indicated by \*), however, must stay within the Amplifier Unit's operating temperature range.

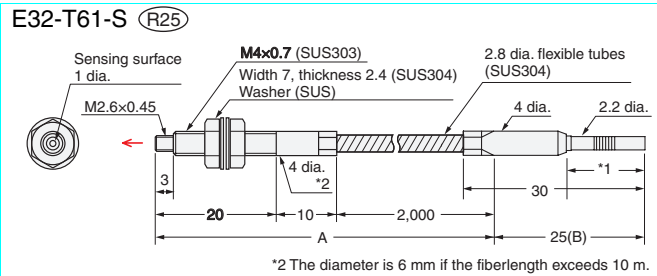

\*2 The diameter is 6 mm if the fiberlength exceeds 10 m.

Note: The maximum allowable temperatures for sections A and B are 200°C and 110°C, respectively. The section inserted into the Amplifier Unit (indicated by \*), however, must stay within the Amplifier Unit's operating temperature range.

**Environment-resistant Models** **Chemical-resistant Models**

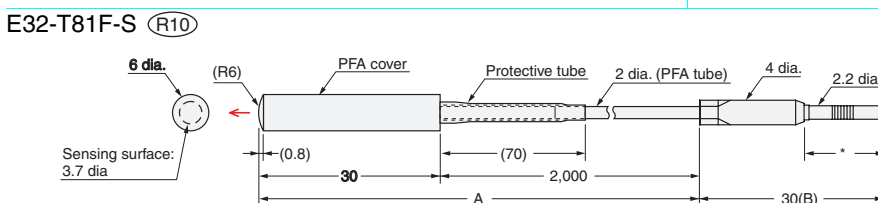
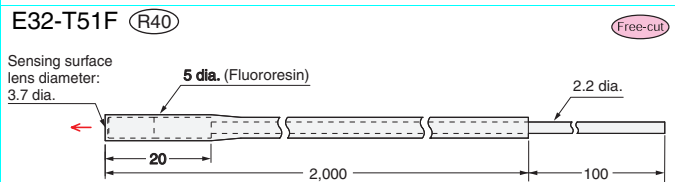
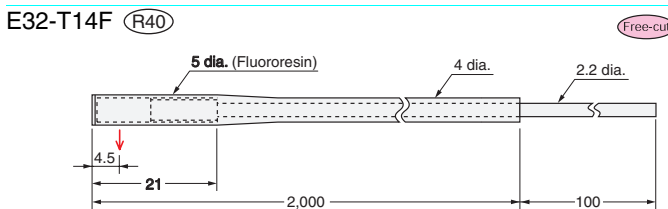
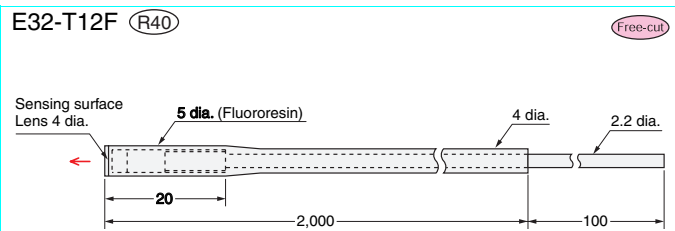
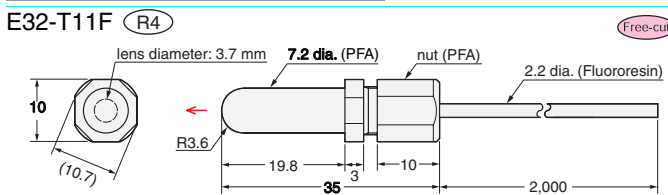

Note: The maximum allowable temperatures for sections A and B are 200°C and 110°C, respectively. The section inserted into the Amplifier Unit (indicated by \*), however, must stay within the Amplifier Unit's operating temperature range.

Environment-resistant Models Vacuum-resistant Models

**R** Flexible **B** Break-resistant **U** Fluororesin coating **R** Standard  
**Free-cut** Cutting free (Cutter provided)

E32-T51V **R30**

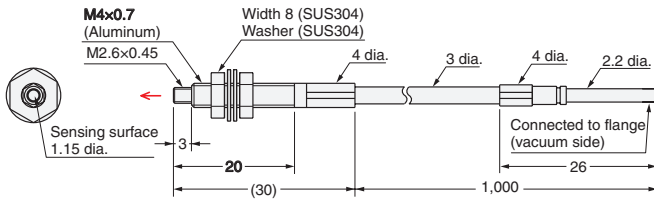

E32-T54V **R30**

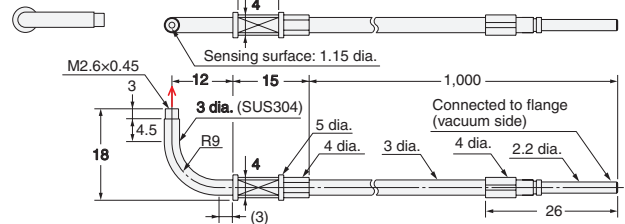

E32-T84SV **R25** Sensing surface: 2 dia.

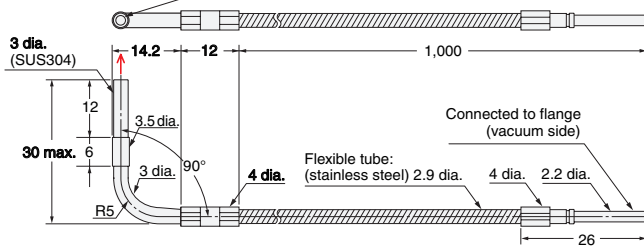

E39-F1V

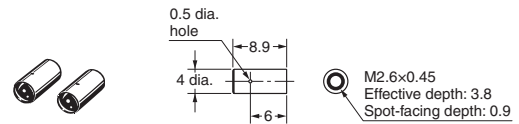

Material: Aluminum for body and optical glass for the lens itself.

E32-VF4

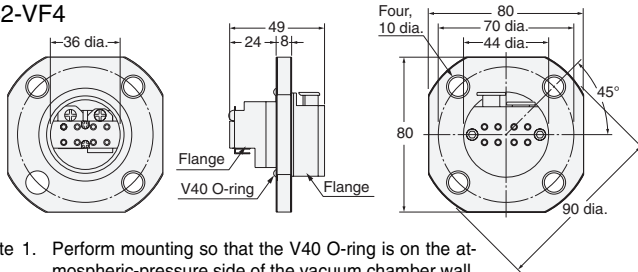

Note 1. Perform mounting so that the V40 O-ring is on the atmospheric-pressure side of the vacuum chamber wall.  
 2. Mounting-hole cutout dimensions: 38 dia. ±0.5 mm

E32-VF1

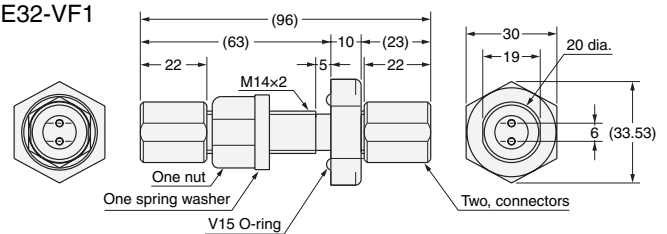

Note 1. Perform mounting so that the V15 O-ring is on the atmospheric-pressure side of the vacuum chamber wall.  
 2. Mounting-hole cutout dimensions: 14.5 dia. ±0.2 mm

E32-T10V-2M **R25** **Free-cut**

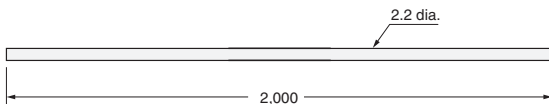

E39-L54V

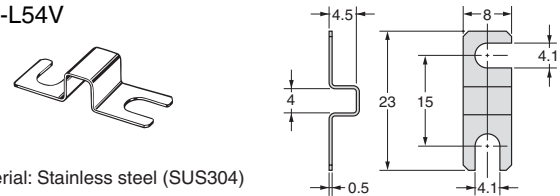

Material: Stainless steel (SUS304)

Mounting hole dimensions (recommended)

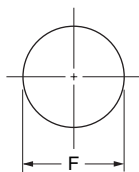

<Screw-mounting Model>

(Unit:mm)

Outer diameter of fiber unit	M3	M4	M6	M14
F dimensions	3 <sup>+0.5</sup> <sub>0</sub> dia.	4 <sup>+0.5</sup> <sub>0</sub> dia.	6 <sup>+0.5</sup> <sub>0</sub> dia.	14 <sup>+1</sup> <sub>0</sub> dia.

Example: Head size of E32-TC200 is M4. Open the mounting holes with 4 to 4.5 dia.

<Cylindrical Model>

(Unit:mm)

Outer diameter of fiber unit	1 dia.	1.5 dia.	2 dia.	3 dia.
F dimensions	1.2 <sup>+0.2</sup> <sub>0</sub> dia.	1.7 <sup>+0.2</sup> <sub>0</sub> dia.	2.2 <sup>+0.2</sup> <sub>0</sub> dia.	3.2 <sup>+0.2</sup> <sub>0</sub> dia.
Outer diameter of fiber unit	3.5 dia.	4 dia.	5 dia.	6 dia.
F dimensions	4 <sup>+0.5</sup> <sub>0</sub> dia.	4.5 <sup>+0.5</sup> <sub>0</sub> dia.	5.5 <sup>+0.5</sup> <sub>0</sub> dia.	6.5 <sup>+0.5</sup> <sub>0</sub> dia.

Example: Head size of E32-T22 is 2 dia.. Open the mounting holes with 2.2 to 2.4 dia.

Minimum bending radius

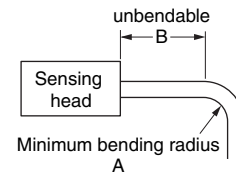

**R** Flexible **B** Break-resistant **U** Fluororesin coating **R** Standard (Unit:mm)

Type	A Minimum bending radius	B unbendable
<b>R</b> (except E32-C11N, E32-C31N and E32-CC200)	1	0
<b>R</b> (E32-C11N, E32-C31N, E32-CC200R)	4	0
<b>B</b> <b>U</b> <b>R4</b>	4	10
<b>R10</b>	10	10
<b>R25</b>	25	10
<b>R30</b>	30	10
<b>R35</b>	35	10
<b>R40</b>	40	10

Fiber Units with Reflective Sensors

Standard Models Standard/Flexible Models

R Flexible 
 B Break-resistant 
 U Fluororesin coating 
 R□ Standard  
Free-cut Cutting free (Cutter provided)

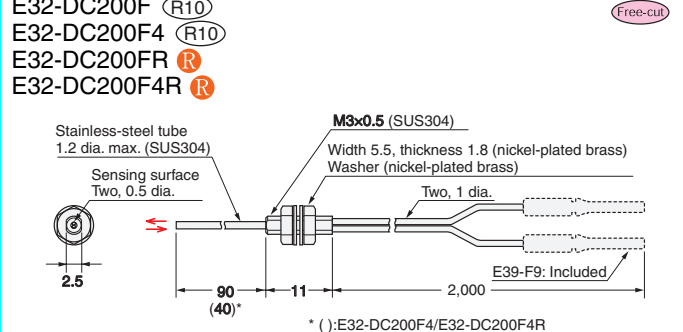
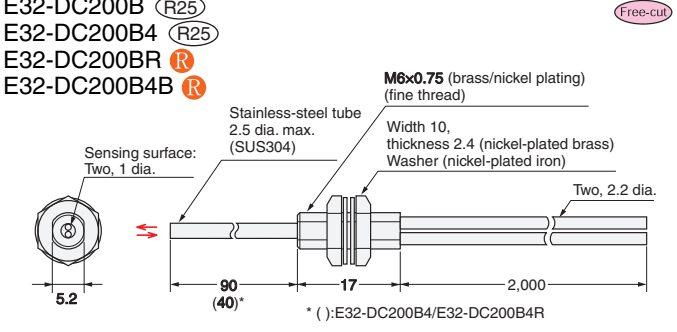
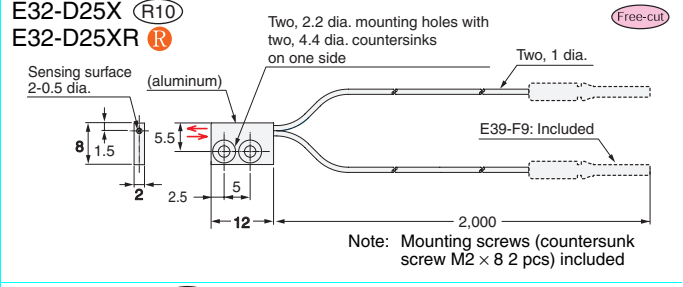
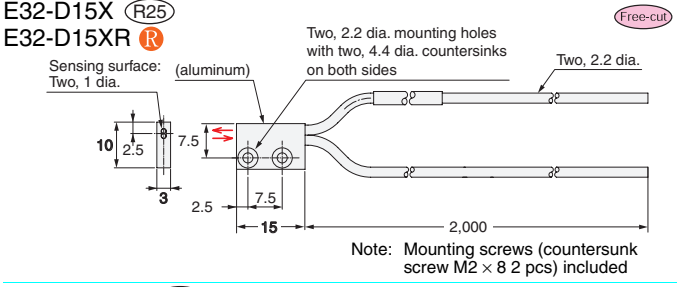
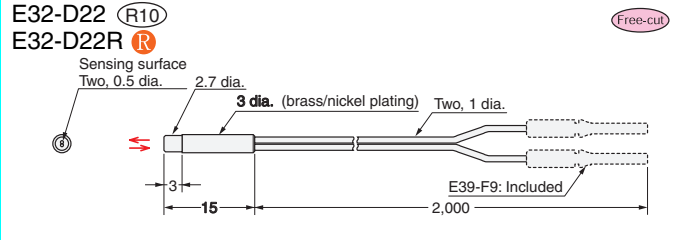
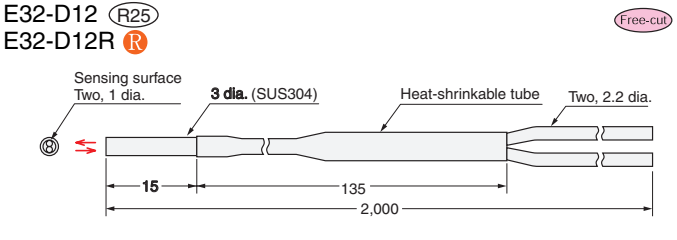
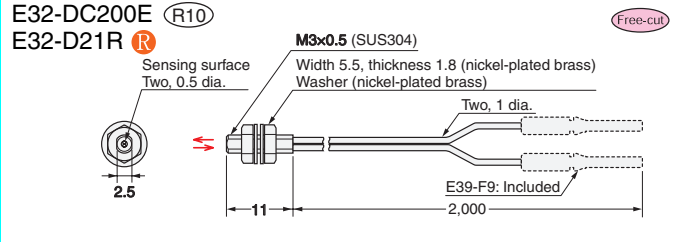
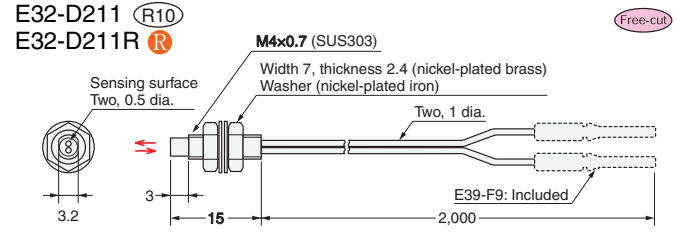
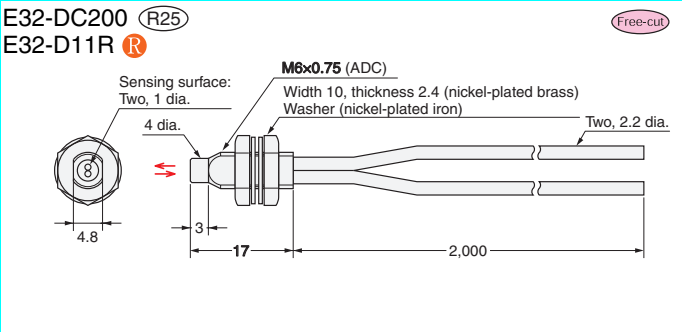
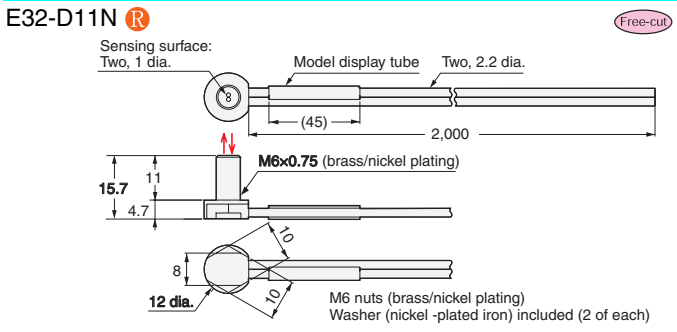



**R** Flexible **B** Break-resistant **U** Fluororesin coating **R□** Standard  
**Free-cut** Cutting free (Cutter provided)

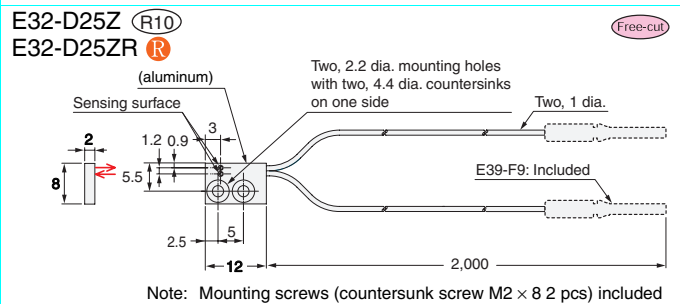
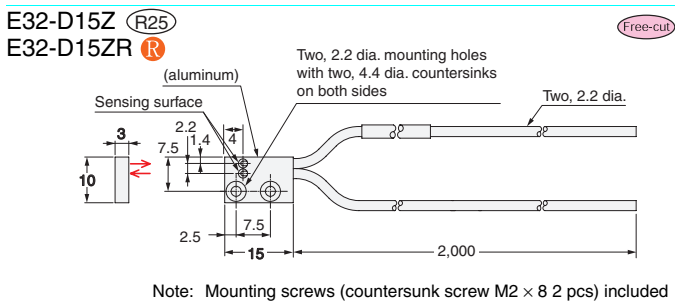
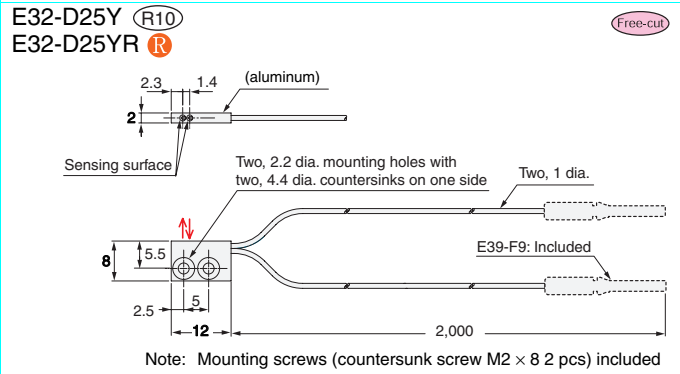
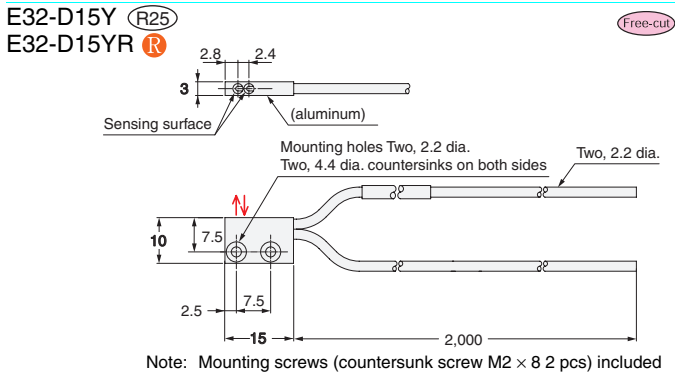
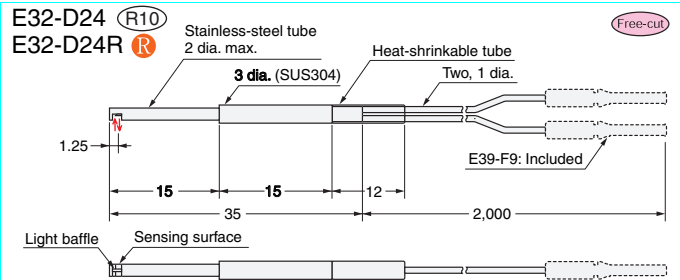
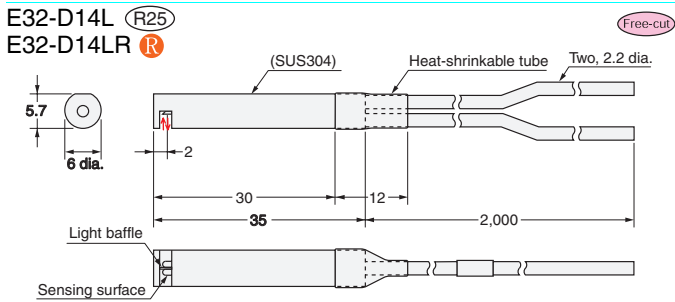

Mounting hole dimensions (recommended)

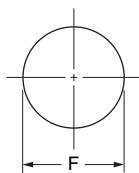

<Screw-mounting Model> (Unit:mm)

Outer diameter of fiber unit	M3	M4	M6	M14
F dimensions	3 <sup>+0.5</sup> <sub>0</sub> dia.	4 <sup>+0.5</sup> <sub>0</sub> dia.	6 <sup>+0.5</sup> <sub>0</sub> dia.	14 <sup>+1</sup> <sub>0</sub> dia.

Example: Head size of E32-TC200 is M4. Open the mounting holes with 4 to 4.5 dia.

<Cylindrical Model> (Unit:mm)

Outer diameter of fiber unit	1 dia.	1.5 dia.	2 dia.	3 dia.
F dimensions	1.2 <sup>+0.2</sup> <sub>0</sub> dia.	1.7 <sup>+0.2</sup> <sub>0</sub> dia.	2.2 <sup>+0.2</sup> <sub>0</sub> dia.	3.2 <sup>+0.2</sup> <sub>0</sub> dia.
Outer diameter of fiber unit	3.5 dia.	4 dia.	5 dia.	6 dia.
F dimensions	4 <sup>+0.5</sup> <sub>0</sub> dia.	4.5 <sup>+0.5</sup> <sub>0</sub> dia.	5.5 <sup>+0.5</sup> <sub>0</sub> dia.	6.5 <sup>+0.5</sup> <sub>0</sub> dia.

Example: Head size of E32-T22 is 2 dia.. Open the mounting holes with 2.2 to 2.4 dia.

Minimum bending radius

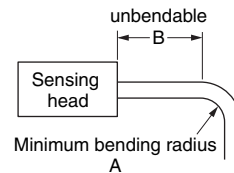

**R** Flexible **B** Break-resistant **U** Fluororesin coating **R□** Standard (Unit:mm)

Type	A Minimum bending radius	B unbendable
(except E32-C11N, E32-C31N and E32-CC200)	1	0
(E32-C11N, E32-C31N, E32-CC200R)	4	0
<b>B</b> <b>U</b> (R4)	4	10
(R10)	10	10
(R25)	25	10
(R30)	30	10
(R35)	35	10
(R40)	40	10

Fiber Units with Reflective Sensors

Standard Models Break-resistant/Coated Models

R Flexible 
 B Break-resistant 
 U Fluororesin coating 
 □ Standard 
 Free-cut Cutting free (Cutter provided)

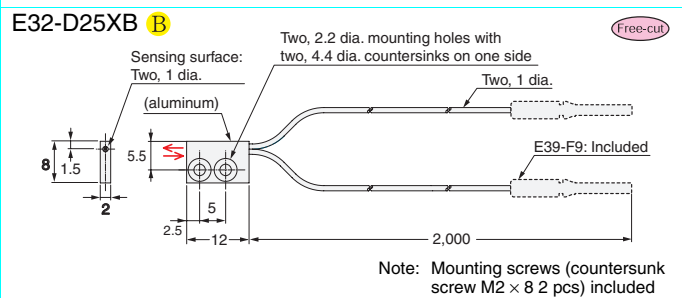
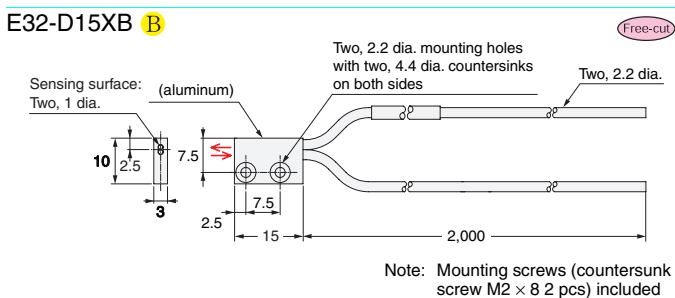
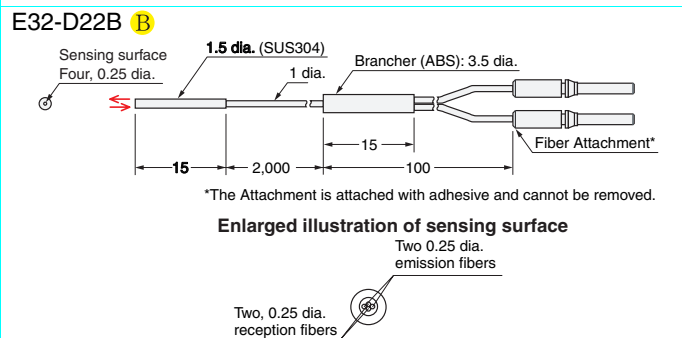
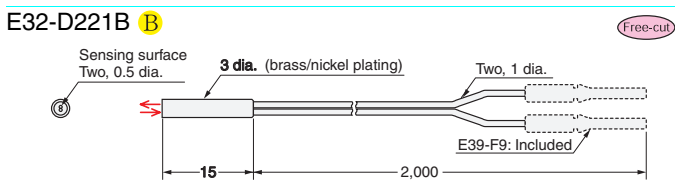
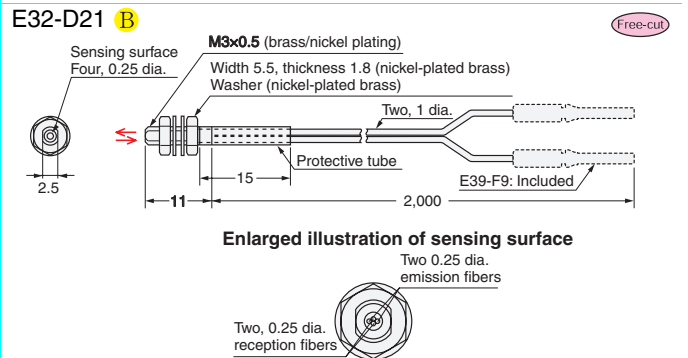
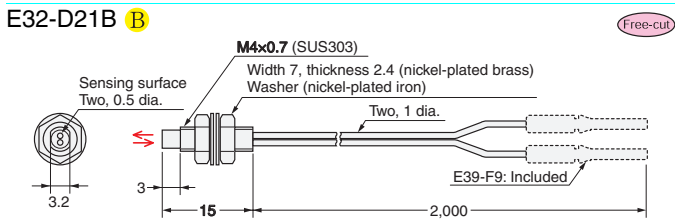
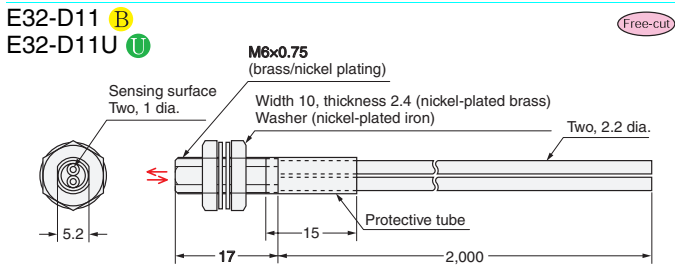

Special-beam Models Long-distance/High-power Models

R Flexible 
 B Break-resistant 
 U Fluororesin coating 
 R□ Standard 
 Free-cut Cutting free (Cutter provided)

E32-D16 B

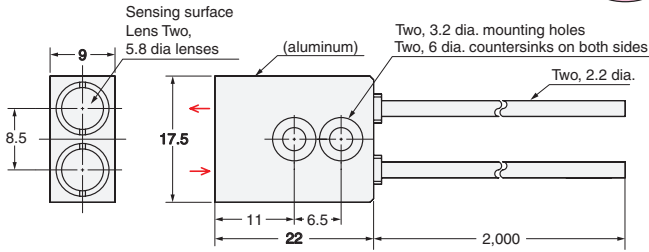

E32-D11L R25

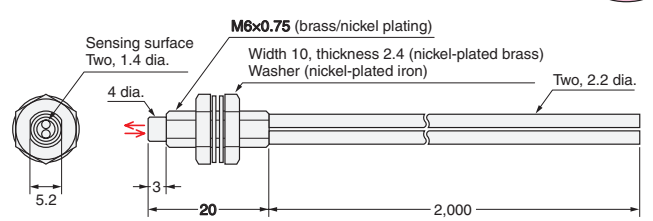

E32-D21L R10

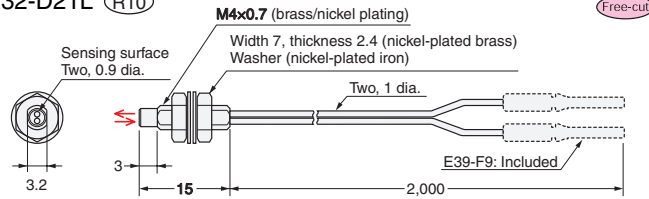

E32-D22L R10

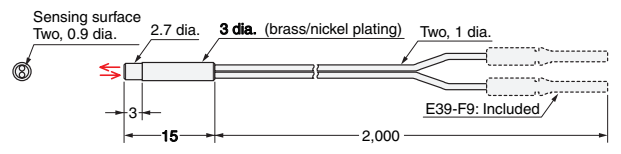

Special-beam Models Ultracompact/Thin-sleeve Models

E32-D33 R4

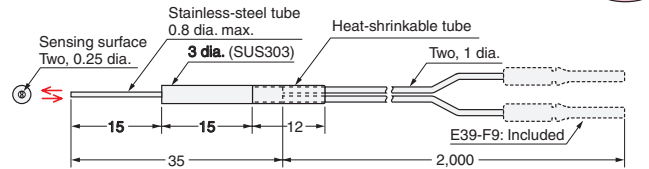

E32-D331 R4

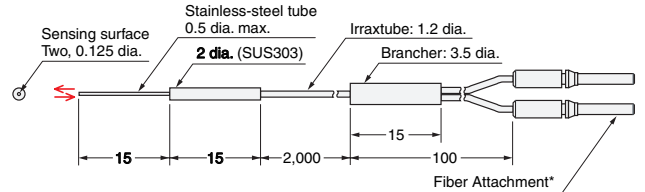

\*The Attachment is attached with adhesive and cannot be removed.

Mounting hole dimensions (recommended)

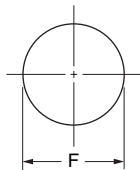

<Screw-mounting Model>

(Unit:mm)

Outer diameter of fiber unit	M3	M4	M6	M14
F dimensions	3 <sup>+0.5</sup> <sub>0</sub> dia.	4 <sup>+0.5</sup> <sub>0</sub> dia.	6 <sup>+0.5</sup> <sub>0</sub> dia.	14 <sup>+1</sup> <sub>0</sub> dia.

Example: Head size of E32-TC200 is M4. Open the mounting holes with 4 to 4.5 dia.

<Cylindrical Model>

(Unit:mm)

Outer diameter of fiber unit	1 dia.	1.5 dia.	2 dia.	3 dia.
F dimensions	1.2 <sup>+0.2</sup> <sub>0</sub> dia.	1.7 <sup>+0.2</sup> <sub>0</sub> dia.	2.2 <sup>+0.2</sup> <sub>0</sub> dia.	3.2 <sup>+0.2</sup> <sub>0</sub> dia.
Outer diameter of fiber unit	3.5 dia.	4 dia.	5 dia.	6 dia.
F dimensions	4 <sup>+0.5</sup> <sub>0</sub> dia.	4.5 <sup>+0.5</sup> <sub>0</sub> dia.	5.5 <sup>+0.5</sup> <sub>0</sub> dia.	6.5 <sup>+0.5</sup> <sub>0</sub> dia.

Example: Head size of E32-T22 is 2 dia.. Open the mounting holes with 2.2 to 2.4 dia.

Minimum bending radius

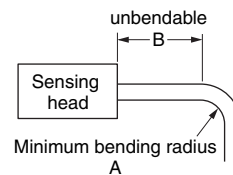

R Flexible 
 B Break-resistant 
 U Fluororesin coating 
 R□ Standard 
 (Unit:mm)

Type	A Minimum bending radius	B unbendable
(except E32-C11N, E32-C31N and E32-CC200)	1	0
(E32-C11N, E32-C31N, E32-CC200R)	4	0
<span style="border: 1px solid black; border-radius: 50%; padding: 2px;">B</span> <span style="border: 1px solid black; border-radius: 50%; padding: 2px;">U</span> <span style="border: 1px solid black; border-radius: 50%; padding: 2px;">R4</span>	4	10
<span style="border: 1px solid black; border-radius: 50%; padding: 2px;">R10</span>	10	10
<span style="border: 1px solid black; border-radius: 50%; padding: 2px;">R25</span>	25	10
<span style="border: 1px solid black; border-radius: 50%; padding: 2px;">R30</span>	30	10
<span style="border: 1px solid black; border-radius: 50%; padding: 2px;">R35</span>	35	10
<span style="border: 1px solid black; border-radius: 50%; padding: 2px;">R40</span>	40	10

Fiber Units with Reflective Sensors

Special-beam Models Coaxial/Small-spot Models

R Flexible 
 B Break-resistant 
 U Fluororesin coating 
 R Standard  
Free-cut Cutting free (Cutter provided)

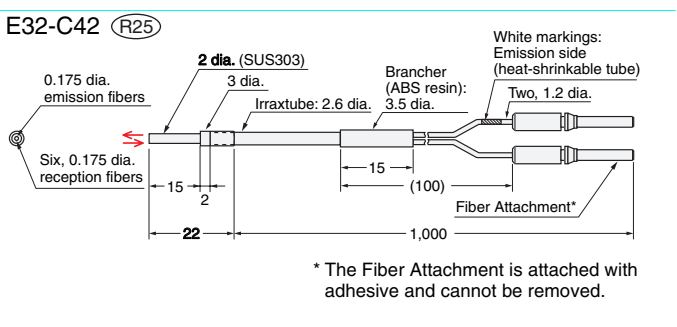
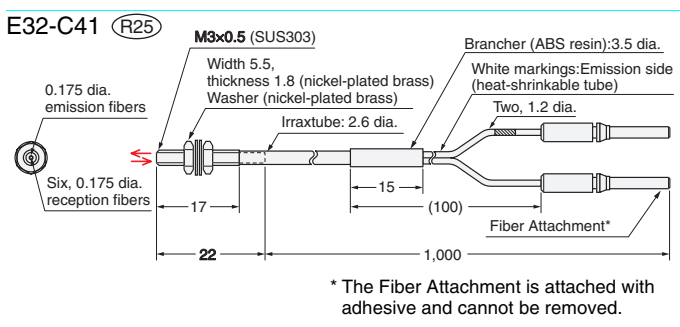
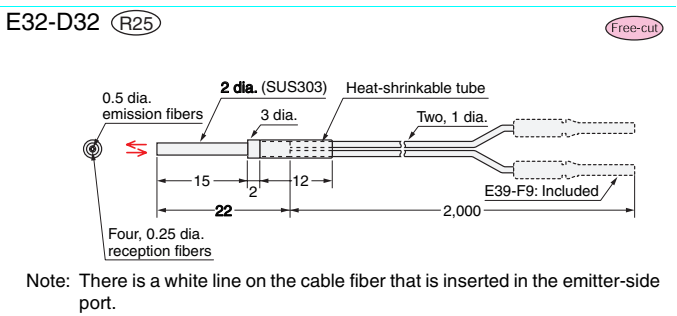
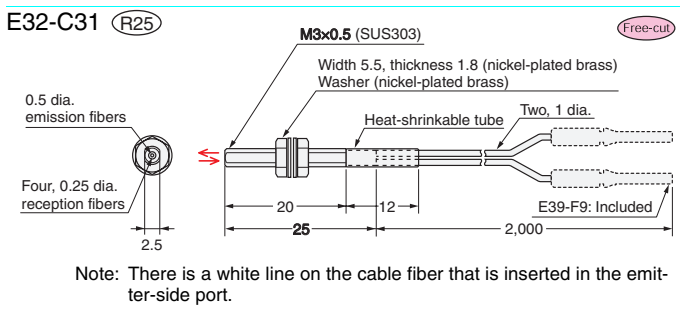
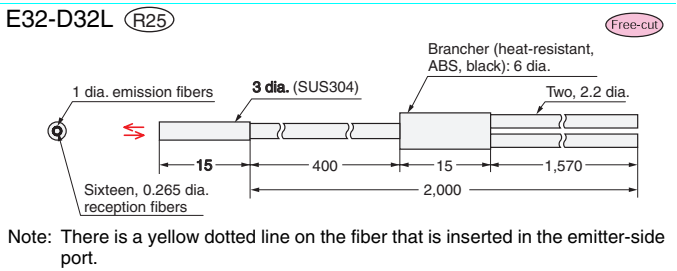
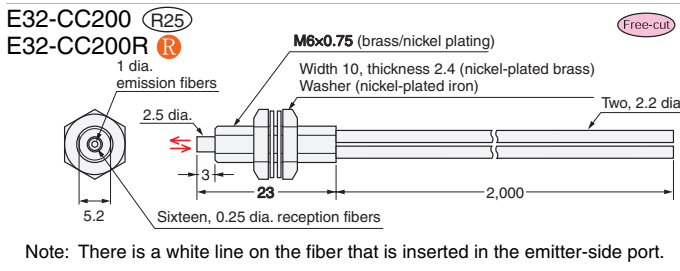
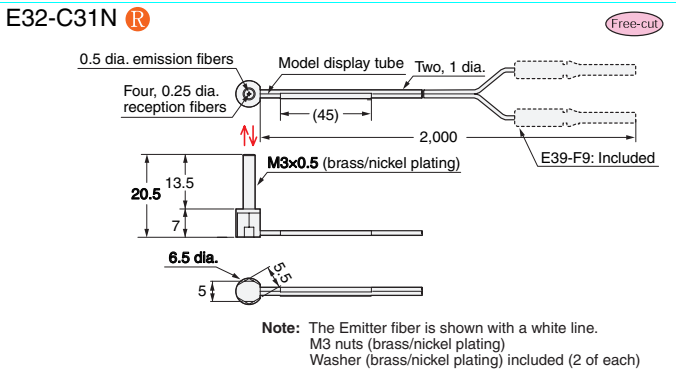
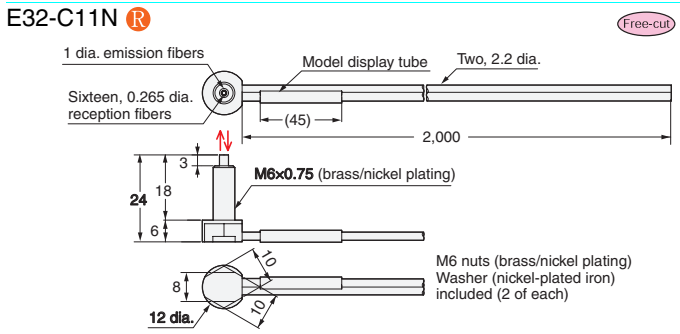

**R** Flexible **B** Break-resistant **U** Fluororesin coating **R□** Standard  
**Free-cut** Cutting free (Cutter provided)

Special-beam Models Area-sensing Models

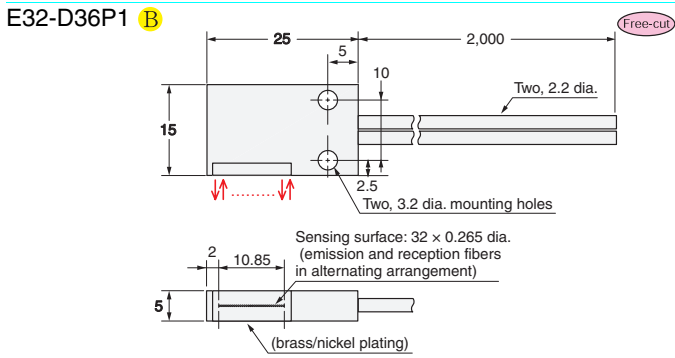

Special-beam Models Retroreflective Fiber Units

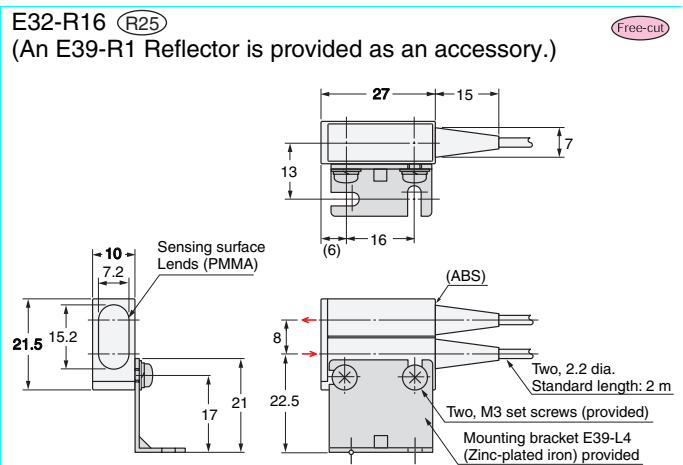
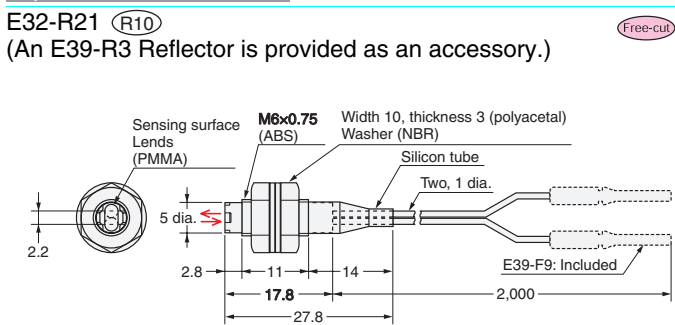

Mounting hole dimensions (recommended)

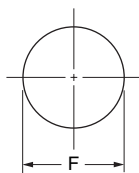

<Screw-mounting Model> (Unit:mm)

Outer diameter of fiber unit	M3	M4	M6	M14
F dimensions	3 <sup>+0.5</sup> <sub>0</sub> dia.	4 <sup>+0.5</sup> <sub>0</sub> dia.	6 <sup>+0.5</sup> <sub>0</sub> dia.	14 <sup>+1</sup> <sub>0</sub> dia.

Example: Head size of E32-TC200 is M4. Open the mounting holes with 4 to 4.5 dia.

<Cylindrical Model> (Unit:mm)

Outer diameter of fiber unit	1 dia.	1.5 dia.	2 dia.	3 dia.
F dimensions	1.2 <sup>+0.2</sup> <sub>0</sub> dia.	1.7 <sup>+0.2</sup> <sub>0</sub> dia.	2.2 <sup>+0.2</sup> <sub>0</sub> dia.	3.2 <sup>+0.2</sup> <sub>0</sub> dia.
Outer diameter of fiber unit	3.5 dia.	4 dia.	5 dia.	6 dia.
F dimensions	4 <sup>+0.5</sup> <sub>0</sub> dia.	4.5 <sup>+0.5</sup> <sub>0</sub> dia.	5.5 <sup>+0.5</sup> <sub>0</sub> dia.	6.5 <sup>+0.5</sup> <sub>0</sub> dia.

Example: Head size of E32-T22 is 2 dia.. Open the mounting holes with 2.2 to 2.4 dia.

Minimum bending radius

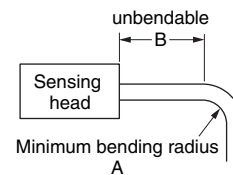

**R** Flexible **B** Break-resistant **U** Fluororesin coating **R□** Standard (Unit:mm)

Type	A Minimum bending radius	B unbendable
<b>R</b> (except E32-C11N, E32-C31N and E32-CC200)	1	0
<b>R</b> (E32-C11N, E32-C31N, E32-CC200R)	4	0
<b>B</b> <b>U</b> <b>R4</b>	4	10
<b>R10</b>	10	10
<b>R25</b>	25	10
<b>R30</b>	30	10
<b>R35</b>	35	10
<b>R40</b>	40	10

Fiber Units with Reflective Sensors

Special-beam Models Convergent-reflective Models

R Flexible 
 B Break-resistant 
 U Fluororesin coating 
 R□ Standard  
Free-cut Cutting free (Cutter provided)

E32-L24S R10

Free-cut

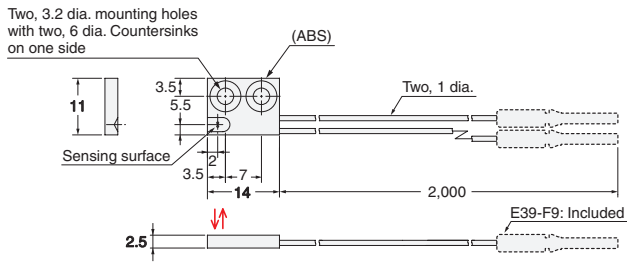

E32-L16-N R25

Free-cut

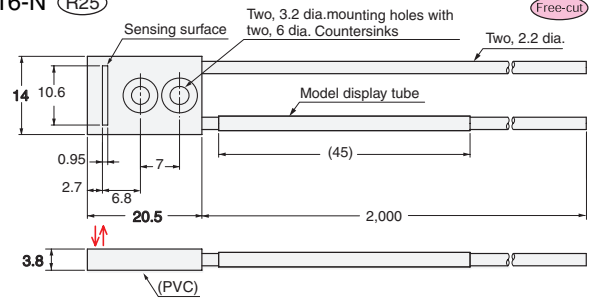

E32-L24L R10

Free-cut

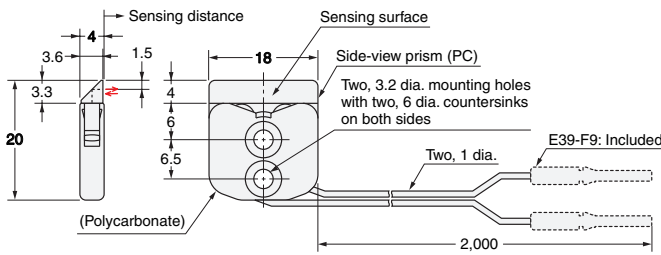

E32-L25L R10

Free-cut

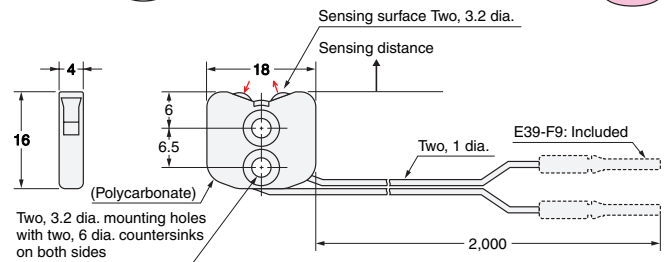

E32-L25 R25

Free-cut

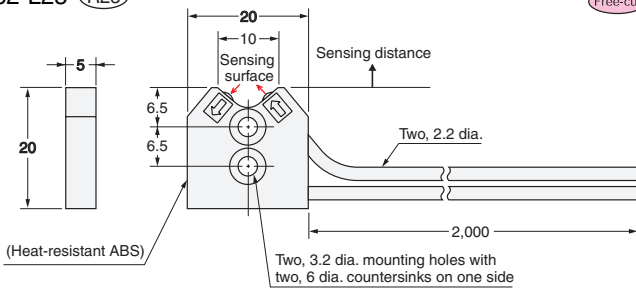

E32-L25A R25

Free-cut

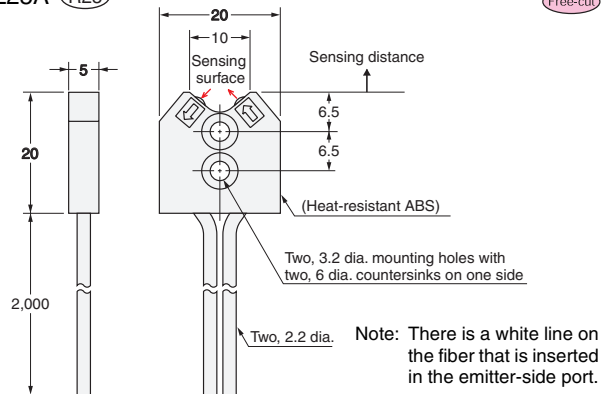

Note: There is a white line on the fiber that is inserted in the emitter-side port.

Note: There is a white line on the fiber that is inserted in the emitter-side port.

Special-beam Models Convergent-reflective Models

R Flexible 
 B Break-resistant 
 U Fluororesin coating 
 R□ Standard  
Free-cut Cutting free (Cutter provided)

E32-L86 R25

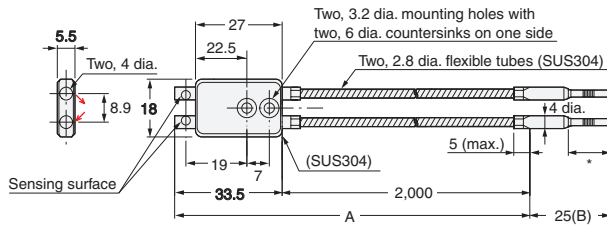

Note: The maximum allowable temperatures for sections A and B are 200°C and 110°C, respectively. The section inserted into the Amplifier Unit (indicated by \*), however, must stay within the Amplifier Unit's operating temperature range.

E32-L64 R25

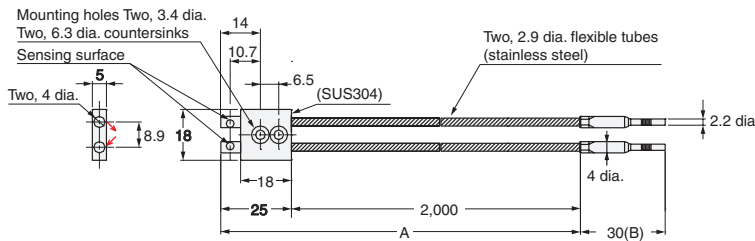

Note: The maximum allowable temperatures are 300°C for section A and 110°C for section B (section inserted into the Amplifier Unit).

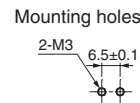

E32-A10 R25

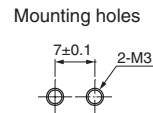
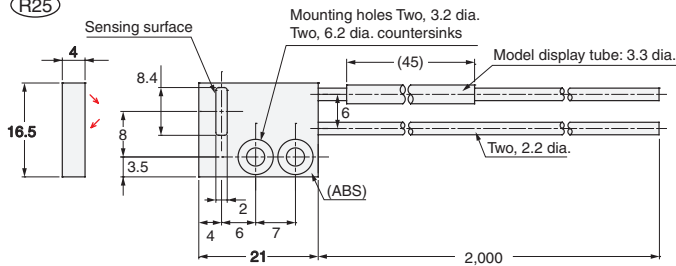

Mounting hole dimensions (recommended)

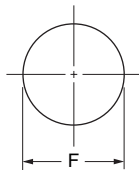

<Screw-mounting Model> (Unit:mm)

Outer diameter of fiber unit	M3	M4	M6	M14
F dimensions	3 <sup>+0.5</sup> <sub>0</sub> dia.	4 <sup>+0.5</sup> <sub>0</sub> dia.	6 <sup>+0.5</sup> <sub>0</sub> dia.	14 <sup>+1</sup> <sub>0</sub> dia.

Example: Head size of E32-TC200 is M4. Open the mounting holes with 4 to 4.5 dia.

<Cylindrical Model> (Unit:mm)

Outer diameter of fiber unit	1 dia.	1.5 dia.	2 dia.	3 dia.
F dimensions	1.2 <sup>+0.2</sup> <sub>0</sub> dia.	1.7 <sup>+0.2</sup> <sub>0</sub> dia.	2.2 <sup>+0.2</sup> <sub>0</sub> dia.	3.2 <sup>+0.2</sup> <sub>0</sub> dia.
Outer diameter of fiber unit	3.5 dia.	4 dia.	5 dia.	6 dia.
F dimensions	4 <sup>+0.5</sup> <sub>0</sub> dia.	4.5 <sup>+0.5</sup> <sub>0</sub> dia.	5.5 <sup>+0.5</sup> <sub>0</sub> dia.	6.5 <sup>+0.5</sup> <sub>0</sub> dia.

Example: Head size of E32-T22 is 2 dia.. Open the mounting holes with 2.2 to 2.4 dia.

Minimum bending radius

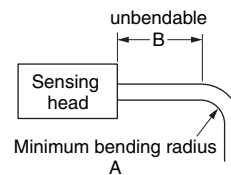

R Flexible 
 B Break-resistant 
 U Fluororesin coating 
 R□ Standard  
 (Unit:mm)

Type	A Minimum bending radius	B unbendable
<span style="border: 1px solid black; border-radius: 50%; padding: 2px;">R</span> (except E32-C11N, E32-C31N and E32-CC200)	1	0
<span style="border: 1px solid black; border-radius: 50%; padding: 2px;">R</span> (E32-C11N, E32-C31N, E32-CC200R)	4	0
<span style="border: 1px solid black; border-radius: 50%; padding: 2px;">B</span> <span style="border: 1px solid black; border-radius: 50%; padding: 2px;">U</span> <span style="border: 1px solid black; border-radius: 50%; padding: 2px;">R4</span>	4	10
<span style="border: 1px solid black; border-radius: 50%; padding: 2px;">R10</span>	10	10
<span style="border: 1px solid black; border-radius: 50%; padding: 2px;">R25</span>	25	10
<span style="border: 1px solid black; border-radius: 50%; padding: 2px;">R30</span>	30	10
<span style="border: 1px solid black; border-radius: 50%; padding: 2px;">R35</span>	35	10
<span style="border: 1px solid black; border-radius: 50%; padding: 2px;">R40</span>	40	10

Fiber Units with Reflective Sensors

Environment-resistant Models Heat-resistant Models

R Flexible 
 B Break-resistant 
 U Fluororesin coating 
 R Standard  
Free-cut Cutting free (Cutter provided)

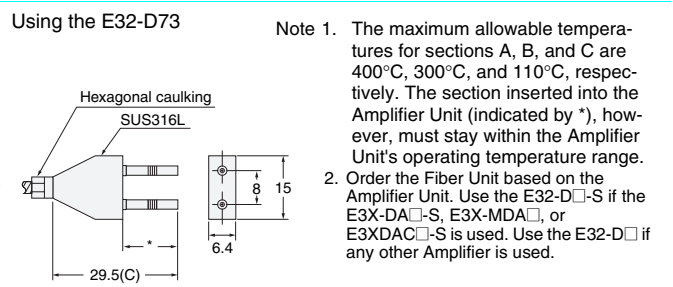
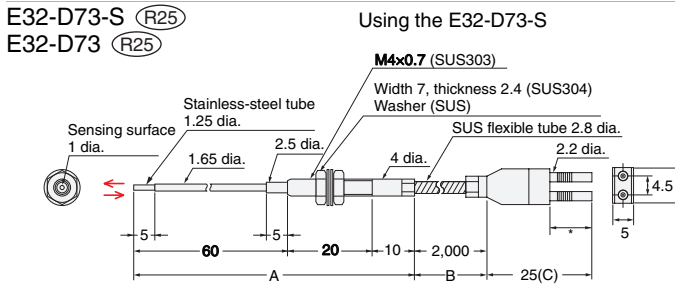
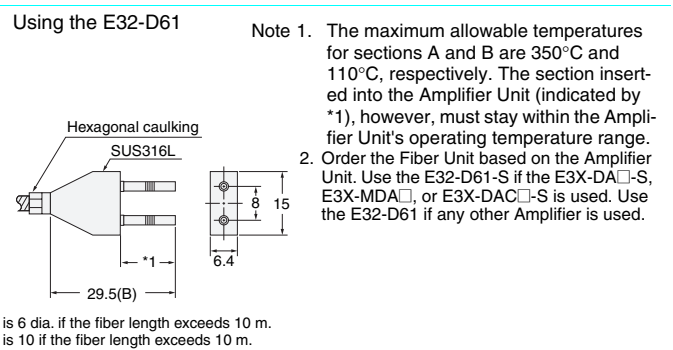
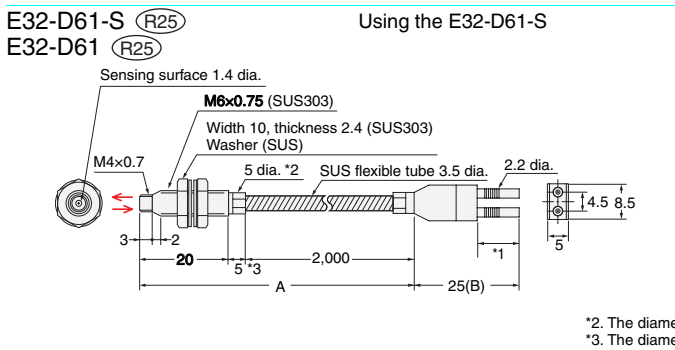
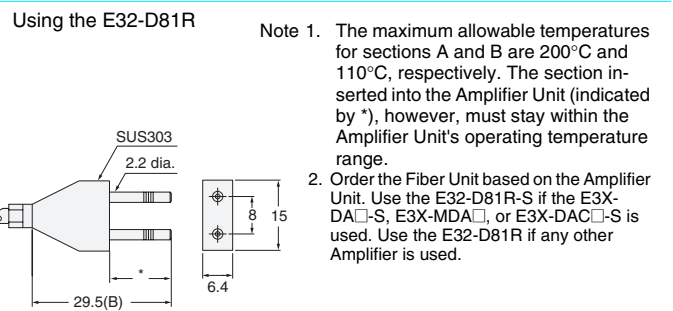
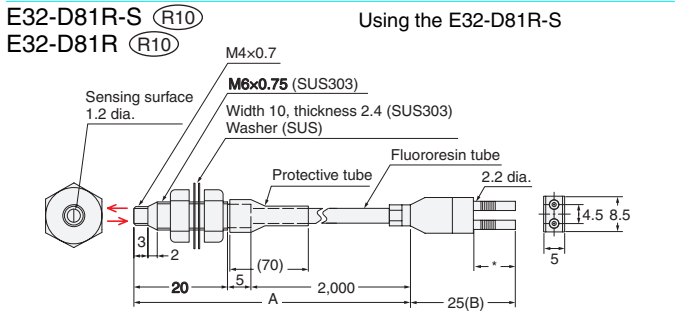
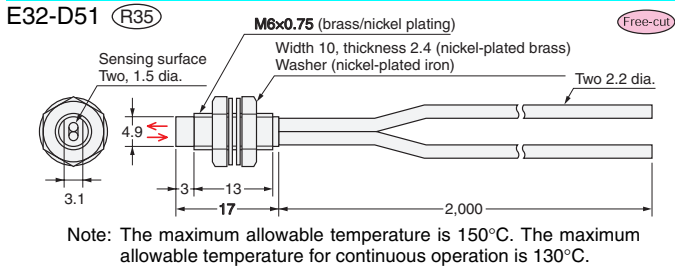

Environment-resistant Models Chemical-resistant Models

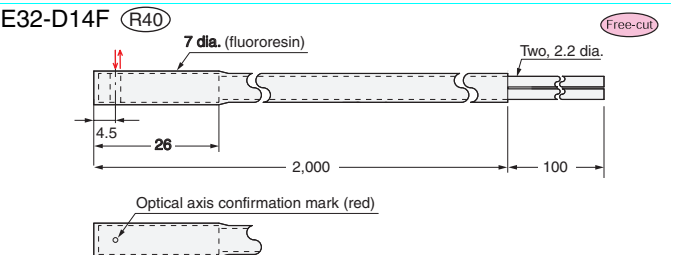
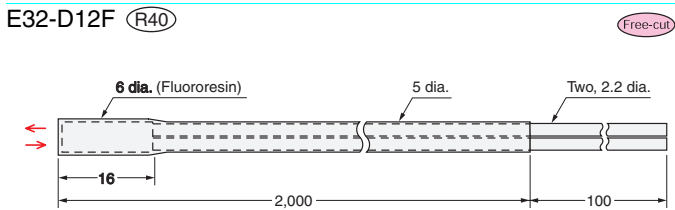



Application-corresponding Fiber Units

Label-detection Models

R Flexible 
 B Break-resistant 
 U Fluororesin coating 
 R□ Standard  
Free-cut Cutting free (Cutter provided)

E32-G14 R25

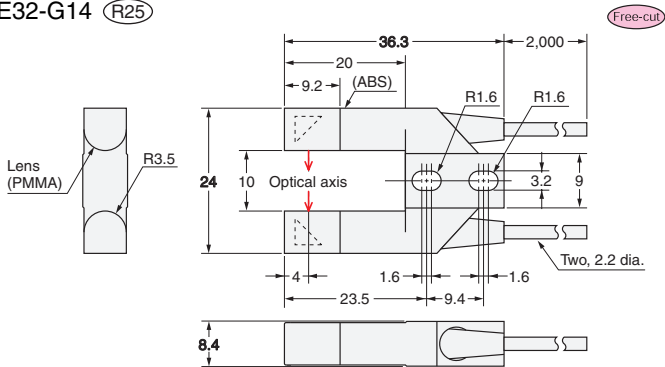

Liquid-level Detection Models

E32-D36T R4

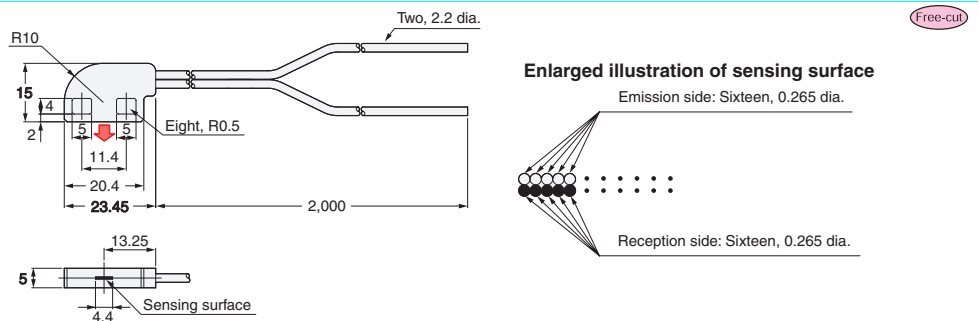

E32-L25T R10

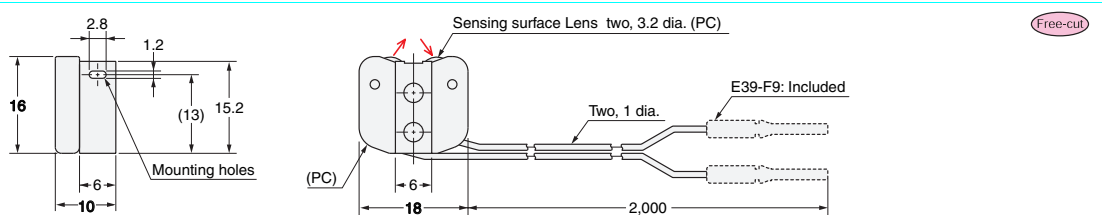

Mounting hole dimensions (recommended)

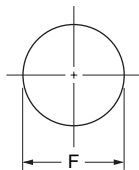

<Screw-mounting Model>

(Unit:mm)

Outer diameter of fiber unit	M3	M4	M6	M14
F dimensions	3 <sup>+0.5</sup> <sub>0</sub> dia.	4 <sup>+0.5</sup> <sub>0</sub> dia.	6 <sup>+0.5</sup> <sub>0</sub> dia.	14 <sup>+1</sup> <sub>0</sub> dia.

Example: Head size of E32-TC200 is M4. Open the mounting holes with 4 to 4.5 dia.

<Cylindrical Model>

(Unit:mm)

Outer diameter of fiber unit	1 dia.	1.5 dia.	2 dia.	3 dia.
F dimensions	1.2 <sup>+0.2</sup> <sub>0</sub> dia.	1.7 <sup>+0.2</sup> <sub>0</sub> dia.	2.2 <sup>+0.2</sup> <sub>0</sub> dia.	3.2 <sup>+0.2</sup> <sub>0</sub> dia.
Outer diameter of fiber unit	3.5 dia.	4 dia.	5 dia.	6 dia.
F dimensions	4 <sup>+0.5</sup> <sub>0</sub> dia.	4.5 <sup>+0.5</sup> <sub>0</sub> dia.	5.5 <sup>+0.5</sup> <sub>0</sub> dia.	6.5 <sup>+0.5</sup> <sub>0</sub> dia.

Example: Head size of E32-T22 is 2 dia.. Open the mounting holes with 2.2 to 2.4 dia.

Minimum bending radius

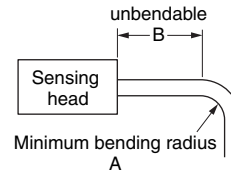

R Flexible 
 B Break-resistant 
 U Fluororesin coating 
 R□ Standard  
 (Unit:mm)

Type	A Minimum bending radius	B un Bendable
<span style="border: 1px solid black; border-radius: 50%; padding: 2px;">R</span> (except E32-C11N, E32-C31N and E32-CC200)	1	0
<span style="border: 1px solid black; border-radius: 50%; padding: 2px;">R</span> (E32-C11N, E32-C31N, E32-CC200R)	4	0
<span style="border: 1px solid black; border-radius: 50%; padding: 2px;">B</span> <span style="border: 1px solid black; border-radius: 50%; padding: 2px;">U</span> <span style="border: 1px solid black; border-radius: 50%; padding: 2px;">R4</span>	4	10
<span style="border: 1px solid black; border-radius: 50%; padding: 2px;">R10</span>	10	10
<span style="border: 1px solid black; border-radius: 50%; padding: 2px;">R25</span>	25	10
<span style="border: 1px solid black; border-radius: 50%; padding: 2px;">R30</span>	30	10
<span style="border: 1px solid black; border-radius: 50%; padding: 2px;">R35</span>	35	10
<span style="border: 1px solid black; border-radius: 50%; padding: 2px;">R40</span>	40	10

Fiber Units with Reflective Sensors

Application-corresponding Fiber Units

Liquid-level Detection Models

R Flexible 
 B Break-resistant 
 U Fluororesin coating 
 R Standard  
Free-cut Cutting free (Cutter provided)

E32-A01 (R4)

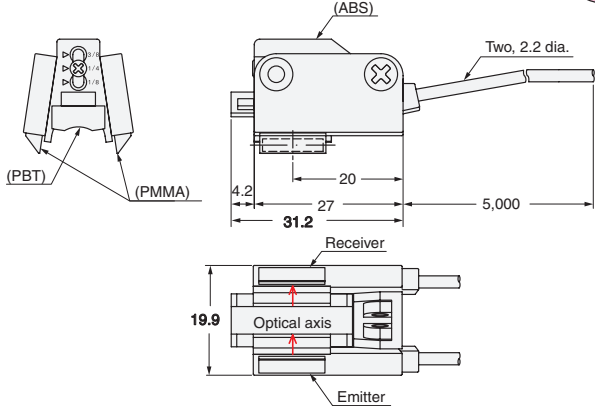

E32-A02 (R4)

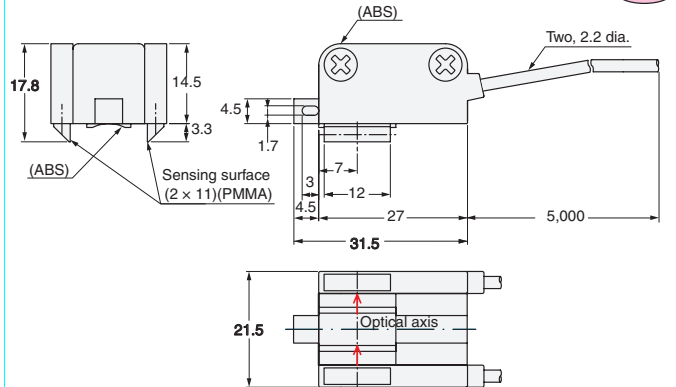

E32-D82F1 (R40)  
E32-D82F2 (R40)

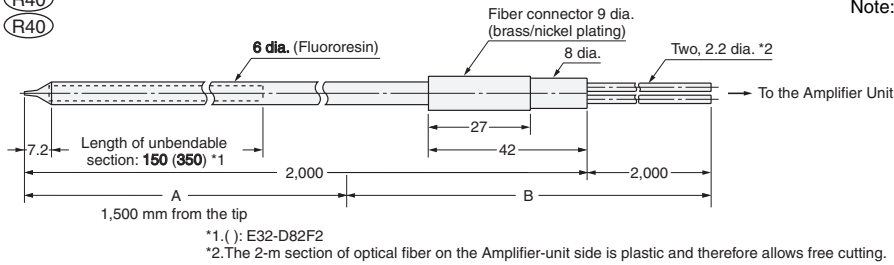

Note: The maximum allowable temperatures for sections A and B are 200°C and 85°C, respectively.

Models for Glass-substrate Alignment/Mapping

E32-A08 (R25)  
E32-A07E1 (R25)  
E32-A07E2 (R25)

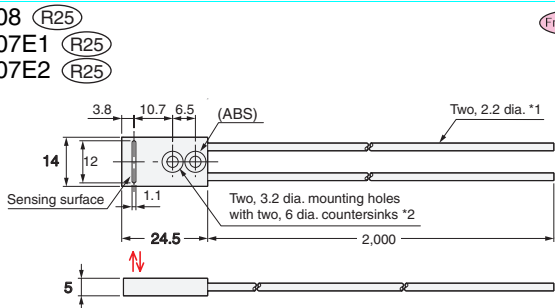

- \*1 The E32-A07E1/E32-A07E2 has a reception fiber and an emission fiber. Use the fiber with a model display tube (fiber with blue dotted line) as light emitting side.
- \*2 E32-A08 : Countersinks on one side  
E32-A07E1/E32-A07E2 : Countersinks on both sides

E32-L66 (R25)

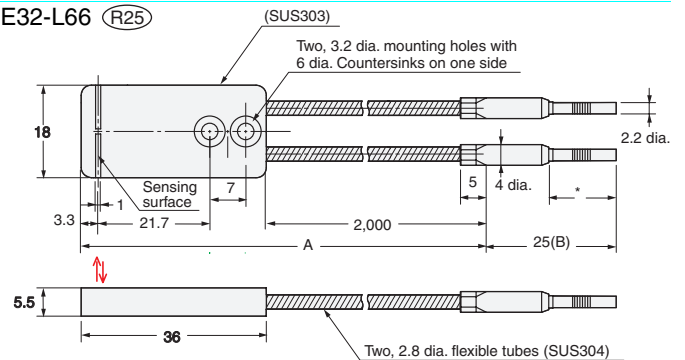

Note: The maximum allowable temperatures for sections A and B are 300°C and 110°C, respectively. The section inserted into the Amplifier Unit (indicated by \*), however, must stay within the Amplifier Unit's operating temperature range.

E32-A08H2 (R25)

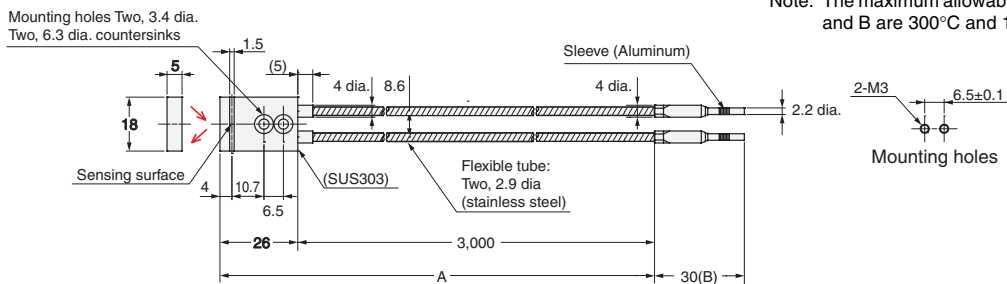

Note: The maximum allowable temperatures for sections A and B are 300°C and 110°C, respectively.

**R** Flexible **B** Break-resistant **U** Fluororesin coating **R□** Standard  
**Free-cut** Cutting free (Cutter provided)

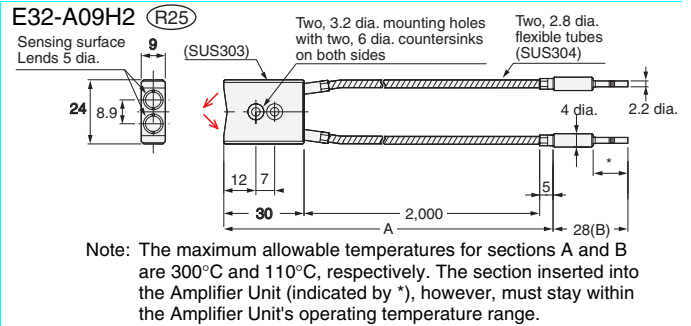
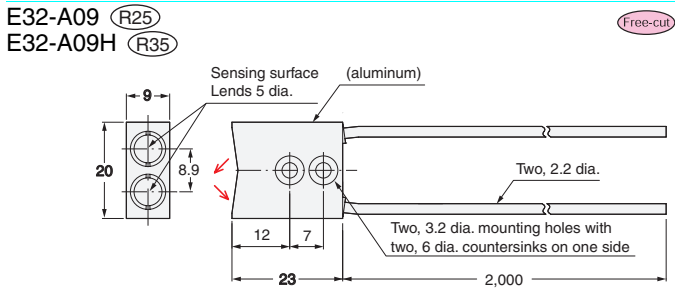

Wafer-mapping Models

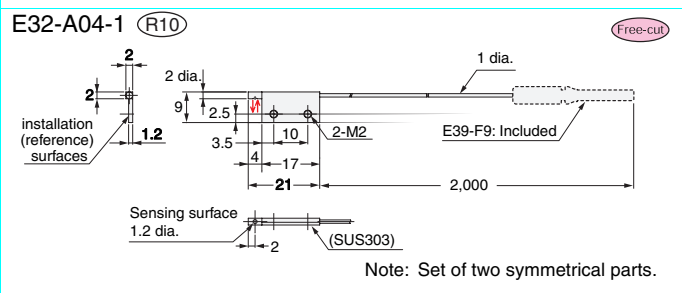
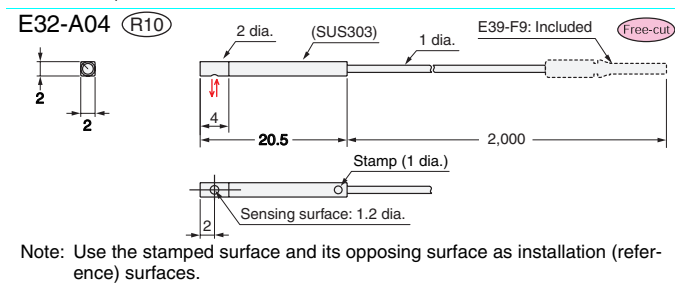
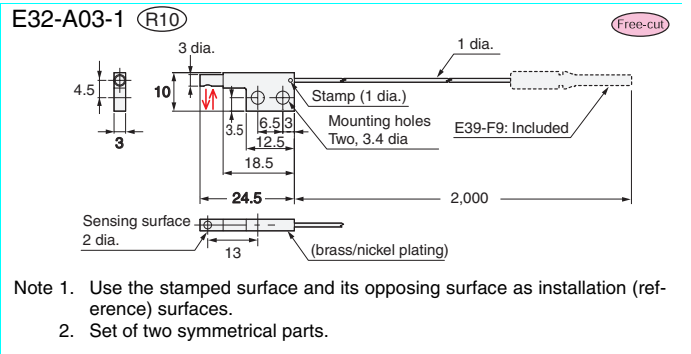
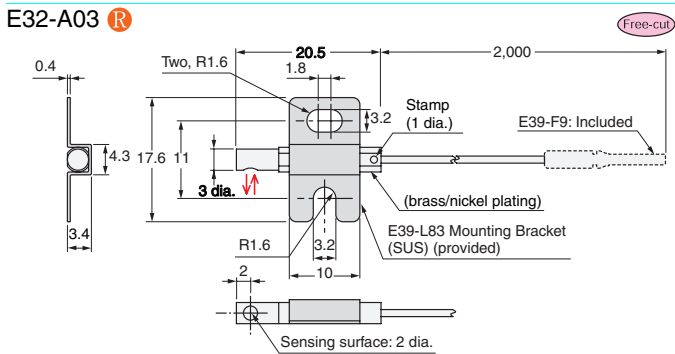

Mounting hole dimensions (recommended)

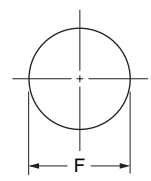

<Screw-mounting Model> (Unit:mm)

Outer diameter of fiber unit	M3	M4	M6	M14
F dimensions	3 <sup>+0.5</sup> <sub>0</sub> dia.	4 <sup>+0.5</sup> <sub>0</sub> dia.	6 <sup>+0.5</sup> <sub>0</sub> dia.	14 <sup>+1</sup> <sub>0</sub> dia.

Example: Head size of E32-TC200 is M4. Open the mounting holes with 4 to 4.5 dia.

<Cylindrical Model> (Unit:mm)

Outer diameter of fiber unit	1 dia.	1.5 dia.	2 dia.	3 dia.
F dimensions	1.2 <sup>+0.2</sup> <sub>0</sub> dia.	1.7 <sup>+0.2</sup> <sub>0</sub> dia.	2.2 <sup>+0.2</sup> <sub>0</sub> dia.	3.2 <sup>+0.2</sup> <sub>0</sub> dia.
Outer diameter of fiber unit	3.5 dia.	4 dia.	5 dia.	6 dia.
F dimensions	4 <sup>+0.5</sup> <sub>0</sub> dia.	4.5 <sup>+0.5</sup> <sub>0</sub> dia.	5.5 <sup>+0.5</sup> <sub>0</sub> dia.	6.5 <sup>+0.5</sup> <sub>0</sub> dia.

Example: Head size of E32-T22 is 2 dia.. Open the mounting holes with 2.2 to 2.4 dia.

Minimum bending radius

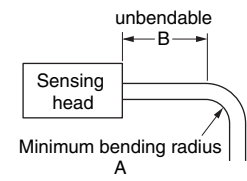

**R** Flexible **B** Break-resistant **U** Fluororesin coating **R□** Standard (Unit:mm)

Type	A Minimum bending radius	B un Bendable
(except E32-C11N, E32-C31N and E32-CC200)	1	0
(E32-C11N, E32-C31N, E32-CC200R)	4	0
<b>B</b> <b>U</b> (R4)	4	10
(R10)	10	10
(R25)	25	10
(R30)	30	10
(R35)	35	10
(R40)	40	10

Accessories

Lens Units

Lens Units  
E39-F1

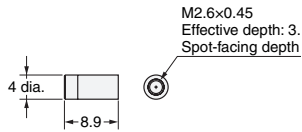

Material:  
Brass for the body and optical glass for the lens itself.

Note: Two per set.

Side-view Units  
E39-F2

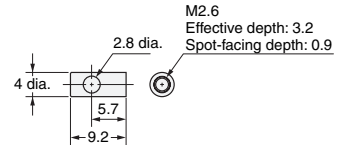

Material:  
Brass for the body and optical glass for the lens itself.

Note: Two per set.

Reflection Unit with Lens  
E39-F3

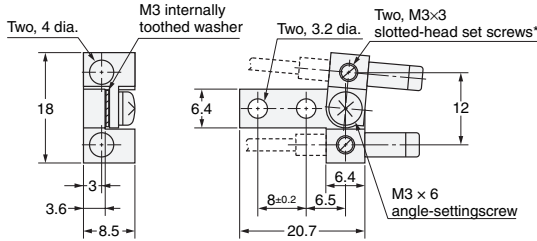

Material:  
Brass for the body and aluminum for the base.

\* Secure the fiber head with the slotted-head set screws. Do not insert a lens (E39-F1).

Lens Unit for Reflective Fiber Units  
E39-F3A

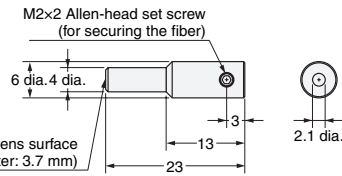

Material:  
Aluminum for body and optical glass for lens.

Note: This is the Lens Unit for the E32-D32 and E32-C42.

Lens Unit for Reflective Fiber Units  
E39-F3A-5

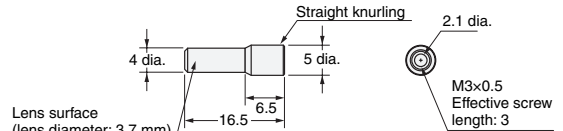

Material:  
Aluminum for body and optical glass for lens

Note: This is the Lens Unit for the E32-C31 and E32-C41.

Lens Unit for Reflective Fiber Units  
E39-F3B

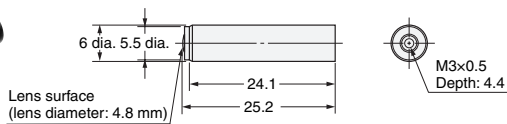

Material:  
Aluminum for body and optical glass for lens.

Note: This is the Lens Unit for the E32-C31 and E32-C41.

Lens Unit for Reflective Fiber Units  
E39-F3C

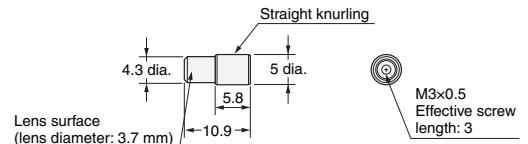

Material:  
Aluminum for body and optical glass for lens.

Note: This is the Lens Unit for the E32-C31 and E32-C41.

Protective Spiral Tubes

E39-F32A/F32A5  
E39-F32B/F32B5

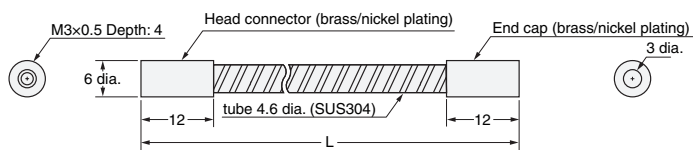

Note 1. The length L is 1,000 for the E39-F32A/-F32B and 500 for the E39-F32A5/-F32B5.  
2. The E39-F32B(5) consists of two E39-F32A(5)s.

E39-F32C/F32C5

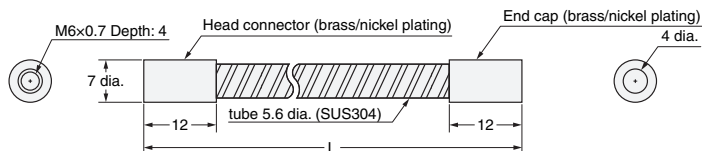
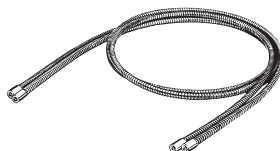

Note: The length L is 1,000 for the E39-F32C and 500 for the E39-F32C5.

E39-F32D/F32D5

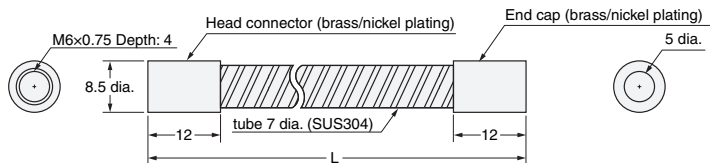

Note: The length L is 1,000 for the E39-F32D and 500 for the E39-F32D5.

Accessories

Other Accessories

Fiber Cutter  
E39-F4

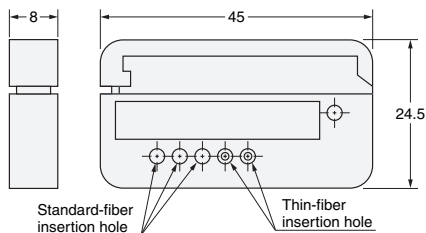

Thin-fiber Attachments  
E39-F9



Material: ABS

Note: Two per set.  
\*Provided with thin-fiber models.

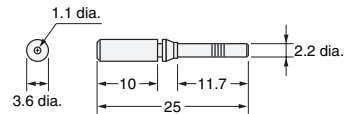

Fiber Connector  
E39-F10

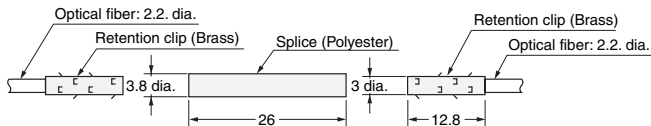
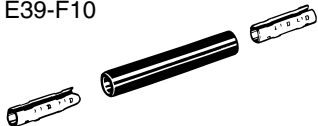

Fiber Connector  
E39-F13  
E39-F14  
E39-F15

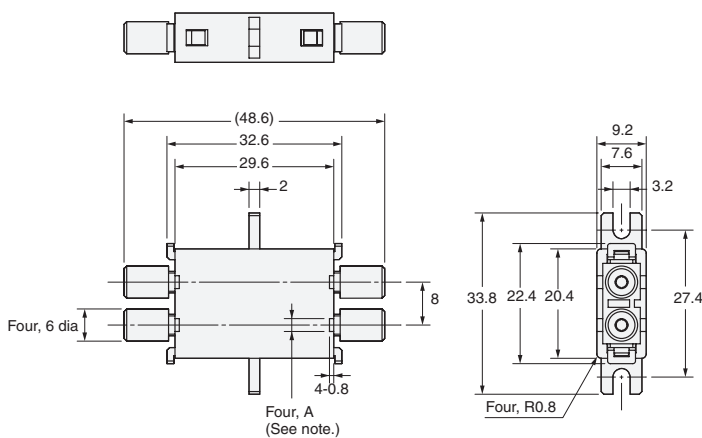

Note: Dimension A varies with the model number as shown in the following table.

Model	Dimension A
E39-F13	2.4
E39-F14	1.2
E39-F15	2.4/1.2

Sleeve Bender  
E39-F11

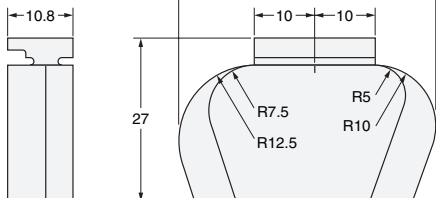

Mounting Bracket  
E39-L83

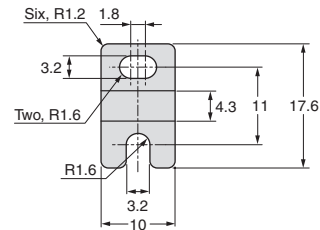
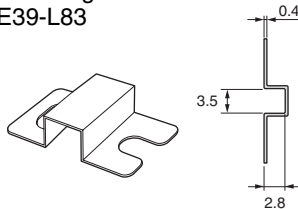

## Safety Precautions

Refer to *Warranty and Limitations of Liability*.

### ⚠ WARNING

This product is not designed or rated for ensuring safety of persons either directly or indirectly. Do not use it for such purposes.



### Precautions for Correct Use

Do not use the product in atmospheres or environments that exceed product ratings.

### Fiber Units

#### ● Mounting

#### Tightening Force

The tightening force used to mount the Fiber Unit must not be more than the value given in Ratings/Characteristics.

#### Screw-mounting Model

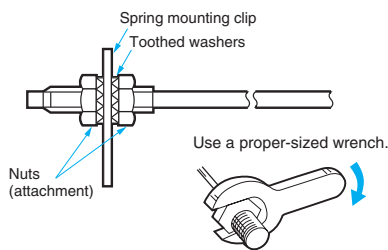

#### Cylindrical Model

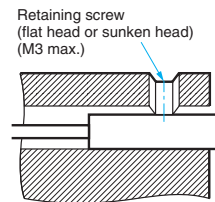

#### Chemical-resistive Models

The following method is recommended to prevent the fluororesin case from cracking when the Sensor is being secured. Be especially careful not to crack the case when using screws to secure the Sensor.

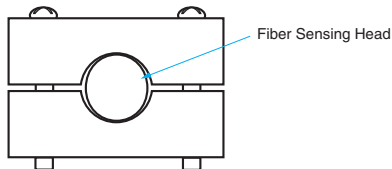

### Fiber Cutting Procedure

Cut a thin fiber as follows:

(1)	The fiber is shipped loosely tightened as shown in the figure at the right.	
(2)	Adjust the fiber to the desired length and then tighten it securely.	
(3)	Insert the fiber to be cut into the E39-F4.	
(4)	Finished state (proper cutting state)	

### Connection

- Do not excessively pull or press the Fiber Unit. Use a pulling force no higher than what is given in *Ratings/Characteristics*.
- Do not bend the Fiber Unit beyond the permissible bending radius given under *Ordering Information*.
- Do not bend the edge of the Fiber Units (excluding the E32-T□R and E32-D□R).

#### Correct

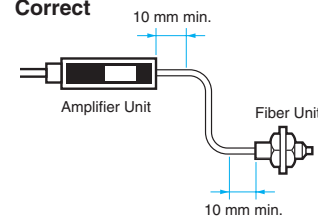

#### Incorrect

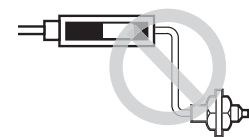

- Do not apply excess force on the Fiber Units.

#### Correct

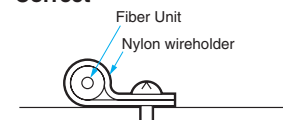

#### Incorrect

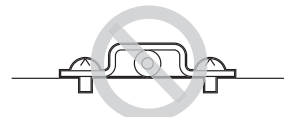

The Fiber Head could be broken by excessive vibration. To prevent this, the following is effective:

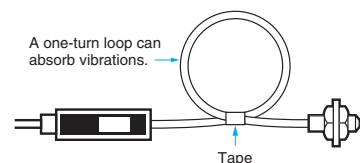

### E39-F11 Sleeve Bender

- The bending radius of the stainless steel tube should be as large as possible. The smaller the bending radius becomes, the shorter the sensing distance will be.
- Insert the tip of the stainless steel tube to the Sleeve Bender and bend the stainless steel tube slowly along the curve of the Sleeve Bender.

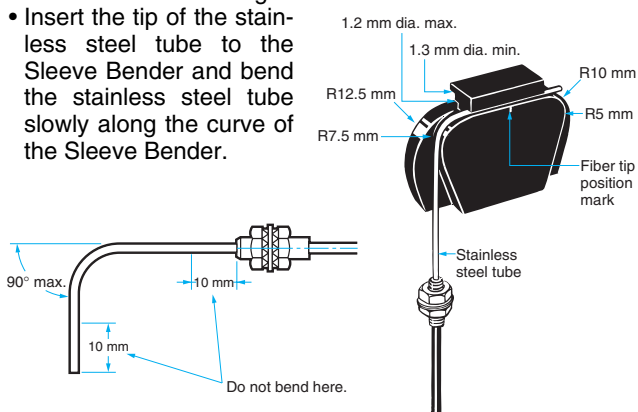

### Heat-resistant Fiber Units

(E32-D51 and E32-T51)

- The fibers of these Units cannot be extended using the E39-F10 Fiber Connector.
- The maximum allowable temperature for continuous operation with these Units is 130°C. It is 150°C for short-term use.

### E32-T14 and E32-G14

These Units may enter the light-ON state if there are reflecting objects at the ends of the lenses. In this case, attach the black stickers provided to the ends of the lenses.

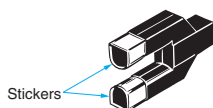

### Wafer Sensors (E32-L25(A))

- To ensure correct performance, insert the fiber with a white line into the emitter-side port of the Amplifier Unit.

### E32-T16 and E32-T16P

#### Example

E32-T16's sensing head

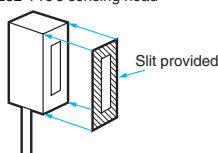

To use the slit provided, peel off the backing sheet, align it with the edges of the sensing surface, and attach it to the sensing head. Use the slit in applications where saturation occurs (i.e., changes in light intensity cannot be obtained) due to short sensing distances.

### E32-M21

Separate the 4 fibers by distances sufficient to prevent interference.

### Vacuum-resistant Fiber Units (E32-V)

Although Flanges, Fiber Units on the vacuum side, and Lens Units have been cleaned, as an extra precaution, clean these products with alcohol before use in high-vacuum environments to ensure that they are properly degreased.

### Liquid-level Detection Sensors (E32-D82F)

- Secure the Fiber Unit using the unbendable section. Otherwise, the liquid-level detection position may be displaced.
- For applications in hazardous environments, install the Fiber Unit in the hazardous environment but install the Amplifier Unit in a safe environment.

### Liquid-level Detection Sensors: Tube-mounting Models

- Ensure that the tube is not deformed when using a band to secure the Fiber Unit.
- Drops of water, bubbles, or haze inside the tube may cause malfunctions.

### E32-A07E1(E2)

There is a difference in sensing object angle between E32-A07E1 and E32-A07E2. Select a model in accordance with the bending direction of a sensing object. Use the fiber with a model display tube as light emitting side.

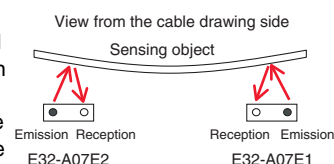

### ● Adjustment

#### E32-G14

When a Digital Fiber Amplifier is used, the sensing distance is short, making the incident light intensity large. This makes it impossible to teach without a workpiece.

### Liquid-level (E32-D82F) Detection Position

The liquid-level detection position is at a distance of 5.2±2 mm from the end of the fluororesin section. (Refer to the diagram on the right.)

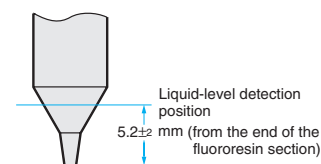

The liquid-level detection position varies with the surface tension of the liquid and the degree of wetness at the Fiber Unit's detection position.

### ● Other Considerations

#### Liquid Level (E32-D82F)

- Operation may become unstable in the following cases:
  - ① Bubbles stick to the cone of the sensing head.
  - ② Solute is deposited on the cone of the sensing head.
  - ③ The liquid has a high viscosity.
- There are some liquids, such as milky white liquids, for which detection is not possible.
- Do not let the end of the fluororesin section bump into another object. Damage to, or deformation of, the sensing head may result in unstable operation.

### Heat-resistant Fiber Units (E32-D81R(-S), E32-D61(-S), and E32-D73(-S))

The pitch of the emission-side and reception-side fiber-insertion ports varies with the Amplifier Unit. Be sure to use an appropriate Fiber Unit.

Amplifier Unit	Fiber Unit
E3X-DA□-S E3X-MDA□	E32-D□-S
E3X-DA□-N E3X-NA□	E32-D□

### Chemical-resistant Fiber and Liquid Level (E32-D82F)

Fluororesin has high chemical resistance. However, applications in the atmosphere of vaporized chemicals (gases) or steam may cause malfunction or damage inside sensors. Run a full check before using in such environments.



■ Accessories

Use of E39-R3 Reflector

1. Use detergent, etc., to remove any dust or oil from the surfaces where tape is applied. Adhesive tape will not be attached properly if oil or dust remains on the surface.
2. The E39-R3 cannot be used in places where it is exposed to oil or chemicals.

E39-F32□ Protective Spiral Tubes

1. Insert a fiber to the Protective Spiral Tube from the head connector side (screwed) of the tube.

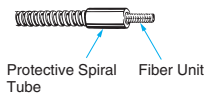

2. Push the fiber into the Protective Spiral Tube. The tube should be straight so that the fiber is not twisted when inserted. Then turn the end cap of the spiral tube.

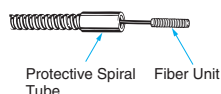

3. Secure the Protective Spiral Tube on a suitable place with the attached nut.

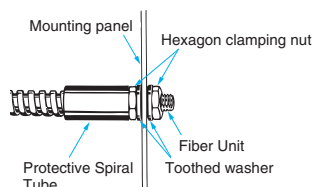

4. Use the attached saddle to secure the end cap of the Protective Spiral Tube. To secure the Protective Spiral Tube at a position other than the end cap, apply tape to the tube so that the portion becomes thicker in diameter.

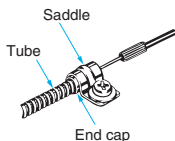

E39-F10 Fiber Connector

Mount the Fiber Connector as shown in the following illustrations.

1. Insert the Fiber Unit into the retention clip.
2. Insert the retention clip into the splice.

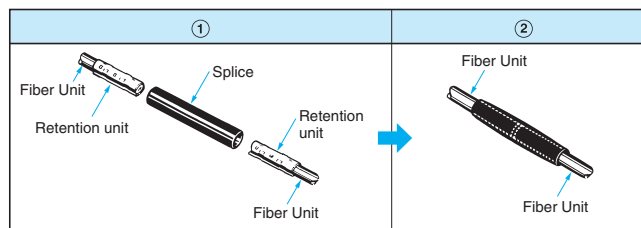

- The Fiber Units should be as close as possible when they are connected. Sensing distance will be reduced by approximately 25% when fibers are connected.
- Only 2.2-mm dia. fibers can be connected.



## **READ AND UNDERSTAND THIS DOCUMENT**

Please read and understand this document before using the products. Please consult your OMRON representative if you have any questions or comments.

## **WARRANTY**

OMRON's exclusive warranty is that the products are free from defects in materials and workmanship for a period of one year (or other period if specified) from date of sale by OMRON.

OMRON MAKES NO WARRANTY OR REPRESENTATION, EXPRESS OR IMPLIED, REGARDING NON-INFRINGEMENT, MERCHANTABILITY, OR FITNESS FOR PARTICULAR PURPOSE OF THE PRODUCTS. ANY BUYER OR USER ACKNOWLEDGES THAT THE BUYER OR USER ALONE HAS DETERMINED THAT THE PRODUCTS WILL SUITABLY MEET THE REQUIREMENTS OF THEIR INTENDED USE. OMRON DISCLAIMS ALL OTHER WARRANTIES, EXPRESS OR IMPLIED.

## **LIMITATIONS OF LIABILITY**

OMRON SHALL NOT BE RESPONSIBLE FOR SPECIAL, INDIRECT, OR CONSEQUENTIAL DAMAGES, LOSS OF PROFITS OR COMMERCIAL LOSS IN ANY WAY CONNECTED WITH THE PRODUCTS, WHETHER SUCH CLAIM IS BASED ON CONTRACT, WARRANTY, NEGLIGENCE, OR STRICT LIABILITY.

In no event shall responsibility of OMRON for any act exceed the individual price of the product on which liability is asserted.

IN NO EVENT SHALL OMRON BE RESPONSIBLE FOR WARRANTY, REPAIR, OR OTHER CLAIMS REGARDING THE PRODUCTS UNLESS OMRON'S ANALYSIS CONFIRMS THAT THE PRODUCTS WERE PROPERLY HANDLED, STORED, INSTALLED, AND MAINTAINED AND NOT SUBJECT TO CONTAMINATION, ABUSE, MISUSE, OR INAPPROPRIATE MODIFICATION OR REPAIR.

## **SUITABILITY FOR USE**

THE PRODUCTS CONTAINED IN THIS DOCUMENT ARE NOT SAFETY RATED. THEY ARE NOT DESIGNED OR RATED FOR ENSURING SAFETY OF PERSONS, AND SHOULD NOT BE RELIED UPON AS A SAFETY COMPONENT OR PROTECTIVE DEVICE FOR SUCH PURPOSES. Please refer to separate catalogs for OMRON's safety rated products.

OMRON shall not be responsible for conformity with any standards, codes, or regulations that apply to the combination of products in the customer's application or use of the product.

At the customer's request, OMRON will provide applicable third party certification documents identifying ratings and limitations of use that apply to the products. This information by itself is not sufficient for a complete determination of the suitability of the products in combination with the end product, machine, system, or other application or use.

The following are some examples of applications for which particular attention must be given. This is not intended to be an exhaustive list of all possible uses of the products, nor is it intended to imply that the uses listed may be suitable for the products:

- Outdoor use, uses involving potential chemical contamination or electrical interference, or conditions or uses not described in this document.
- Nuclear energy control systems, combustion systems, railroad systems, aviation systems, medical equipment, amusement machines, vehicles, safety equipment, and installations subject to separate industry or government regulations.
- Systems, machines, and equipment that could present a risk to life or property.

Please know and observe all prohibitions of use applicable to the products.

NEVER USE THE PRODUCTS FOR AN APPLICATION INVOLVING SERIOUS RISK TO LIFE OR PROPERTY WITHOUT ENSURING THAT THE SYSTEM AS A WHOLE HAS BEEN DESIGNED TO ADDRESS THE RISKS, AND THAT THE OMRON PRODUCT IS PROPERLY RATED AND INSTALLED FOR THE INTENDED USE WITHIN THE OVERALL EQUIPMENT OR SYSTEM.

## **PERFORMANCE DATA**

Performance data given in this document is provided as a guide for the user in determining suitability and does not constitute a warranty. It may represent the result of OMRON's test conditions, and the users must correlate it to actual application requirements. Actual performance is subject to the OMRON Warranty and Limitations of Liability.

## **CHANGE IN SPECIFICATIONS**

Product specifications and accessories may be changed at any time based on improvements and other reasons.

It is our practice to change model numbers when published ratings or features are changed, or when significant construction changes are made. However, some specifications of the product may be changed without any notice. When in doubt, special model numbers may be assigned to fix or establish key specifications for your application on your request. Please consult with your OMRON representative at any time to confirm actual specifications of purchased products.

## **DIMENSIONS AND WEIGHTS**

Dimensions and weights are nominal and are not to be used for manufacturing purposes, even when tolerances are shown.

## **ERRORS AND OMISSIONS**

The information in this document has been carefully checked and is believed to be accurate; however, no responsibility is assumed for clerical, typographical, or proofreading errors, or omissions.

## **PROGRAMMABLE PRODUCTS**

OMRON shall not be responsible for the user's programming of a programmable product, or any consequence thereof.

## **COPYRIGHT AND COPY PERMISSION**

This document shall not be copied for sales or promotions without permission.

This document is protected by copyright and is intended solely for use in conjunction with the product. Please notify us before copying or reproducing this document in any manner, for any other purpose. If copying or transmitting this document to another, please copy or transmit it in its entirety.