

# SPECIFICATIONS

1/9

1. Scope of Application

These specifications are applied to the chip type LED lamp , model CL-L251-MC4W1-C

2. Part code

## CL - L 2 5 1 - M C 4 W 1 - C

Series \_\_\_\_\_

L251 : White power LED for general lighting.

Special specifications \_\_\_\_\_

M : General Color Rendering Index Typ. 85 Type.

Watt Class \_\_\_\_\_

C4 : 4 watt package.

Lighting color \_\_\_\_\_

W1 : Energy Star Correlated Color Temperature 4000(K)

			Approved	Checked	Drawn	Symbol	CITILED
						Name	CL-L251-MC4W1-C
						Drawing No	
-	2010/3/1	Issue of first edition					
Mark	Date	Description	CITIZEN ELECTRONICS CO.,LTD.				

# SPECIFICATIONS

2/9

### 3. Outline drawing

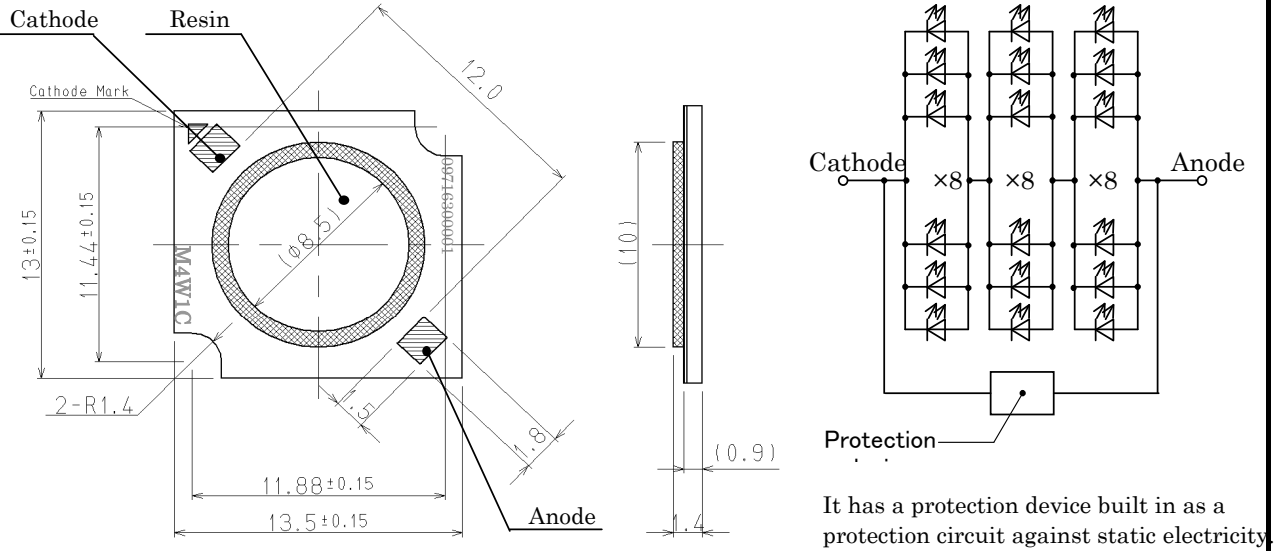

### 4. Performance

#### (1) Absolute Maximum Rating

Parameter	Symbol	Rating Value	Unit
Power Dissipation	$P_D$	5.9	W
Forward Current	$I_F$	560	mA
Forward Pulse Current	$I_{FP}$	800	mA
Reverse Current	$I_R$	1	mA
Operating Temperature	$T_{OP}$	-30 ~ +85	C
Storage Temperature	$T_{ST}$	-40 ~ +100	C
Junction Temperature	$T_{j\ Max}$	120	C

\*1 Forward Current : Duty  $\leq 1/10$  , Pulse Width  $\leq 10\text{msec}$

\*2 D.C. Current :  $T_j = T_c + R_j \cdot c \times P_D$

Pulse Current :  $T_j = T_c + R_j \cdot c \times P_w(\text{Power Dissipation / one-Pulse}) \times \text{duty}$

			Approved	Checked	Drawn	Symbol	CITILED
						Name	CL-L251-MC4W1-C
						Drawing No	
-	2010/3/1	Issue of first edition					
Mark	Date	Description	Appro.	CITIZEN ELECTRONICS CO.,LTD.			

# SPECIFICATIONS

3/9

## ( 2 ) Electro-optical Characteristics

( Tc=25 C )

Parameter	Symbol	Condition	Min.	Typ.	Max.	Unit
Forward Voltage	$V_F$	$I_F=480mA$	8.75	9.30	10.5	V
Luminous Flux	$\Phi_v$	$I_F=480mA$	289	340	-	lm
General Color Rendering Index	Ra	$I_F=480mA$	-	85	-	-
Thermal Resistance	Rj-c	Junction-case	-	6.0	-	C/W

Chromaticity coordinates ( Condition :  $I_F=480mA$  , Tc=25 C )

Color rank		x	y
W1	Center	0.3818	0.3797
	a	0.4006	0.4044
	b	0.3736	0.3874
	c	0.3670	0.3578
	d	0.3898	0.3716

\*Color region stay with in MacAdam "3-step" ellipse from center.

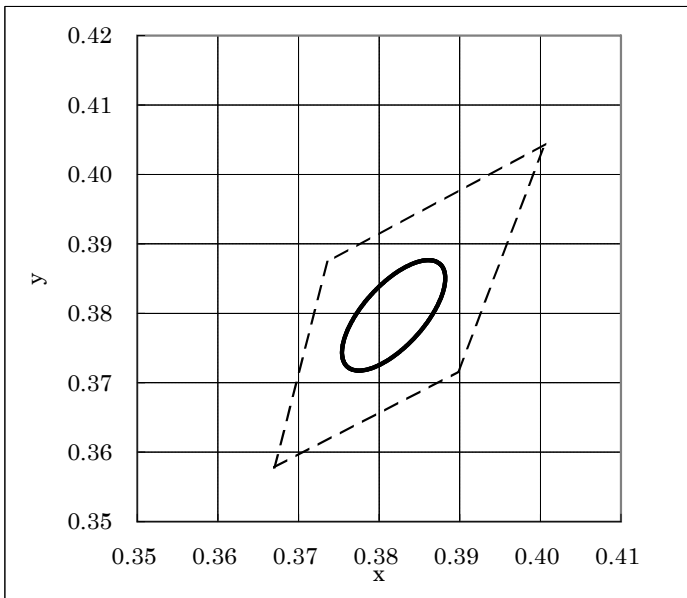

Note: The tolerance of measurement at our tester is  $V_F \pm 3\%$  ,  $\Phi_v \pm 10\%$  , Chromaticity(x,y)  $\pm 0.005$ .

			Approved	Checked	Drawn	Symbol	CITILED
						Name	CL-L251-MC4W1-C
						Drawing No	
-	2010/3/1	Issue of first edition					
Mark	Date	Description	Appro.	CITIZEN ELECTRONICS CO.,LTD.			

5. Characteristics

Forward Current vs. Forward Voltage

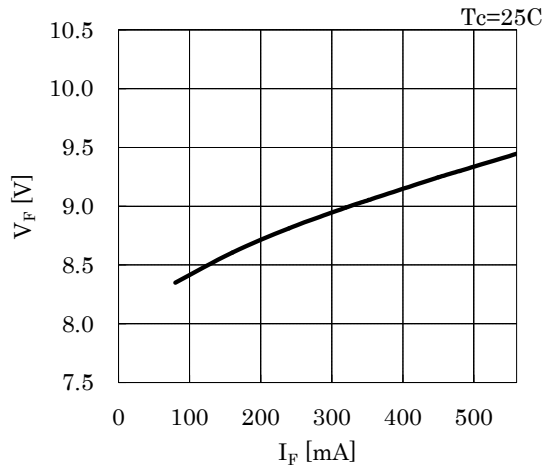

Forward Current vs. Relative Luminous Flux

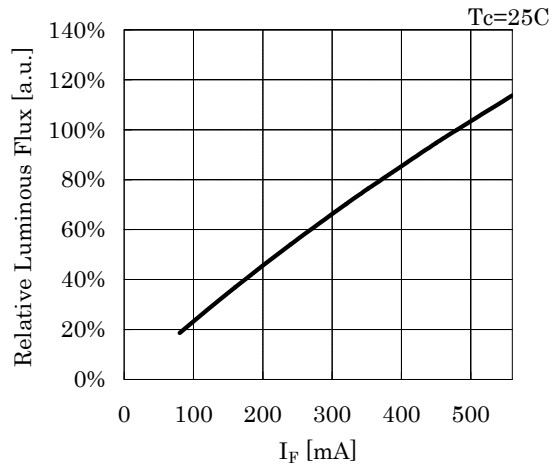

Forward Current vs. Chromaticity Coordinate

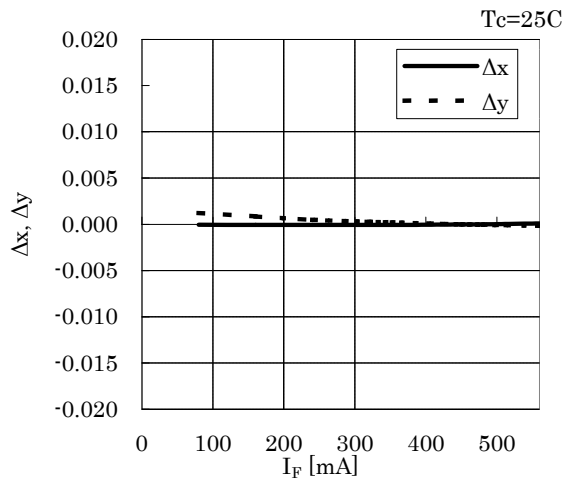

Case Temperature vs. Chromaticity Coordinate

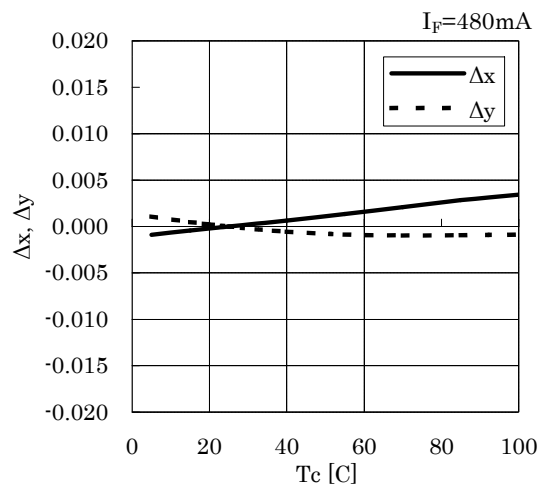

			Approved	Checked	Drawn	Symbol	CITILED
						Name	CL-L251-MC4W1-C
						Drawing No	
-	2010/3/1	Issue of first edition					
Mark	Date	Description Appro.	CITIZEN ELECTRONICS CO.,LTD.				

Case Temperature vs. Forward Voltage

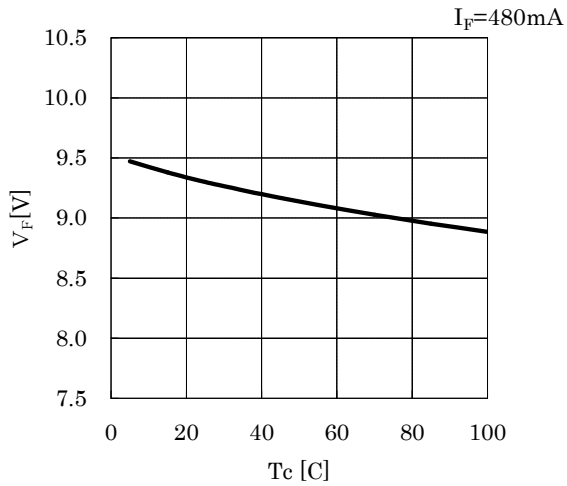

Case Temperature vs. Relative Luminous Flux

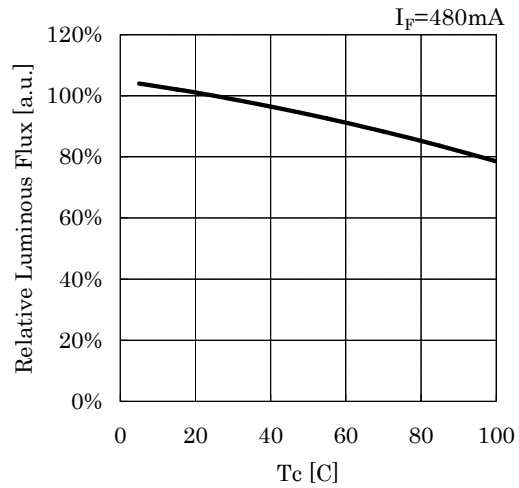

Case Temperature vs. Allowable Forward Current

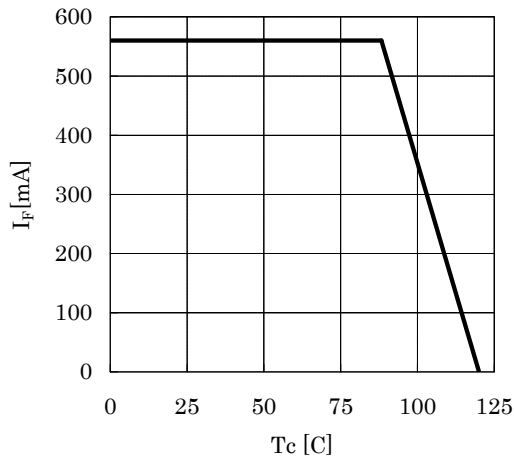

Spectrum

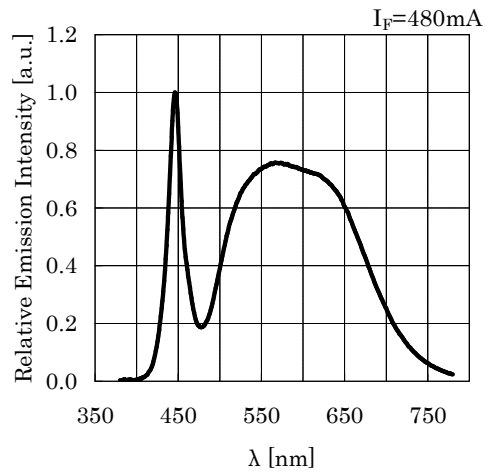

			Approved	Checked	Drawn	Symbol	CITILED
						Name	CL-L251-MC4W1-C
						Drawing No	
-	2010/3/1	Issue of first edition					
Mark	Date	Description	Appro.	CITIZEN ELECTRONICS CO.,LTD.			

# SPECIFICATIONS

6/9

## 6. Reliability

### (1) Details of the tests

Test Item	Test Condition
Continuous Operation Test	Ta=-25 C, I <sub>F</sub> =480 mA× 1000 hours(with Al-fin)
	Ta=50 C,I <sub>F</sub> =480 mA× 1000 hours(with Al-fin)
Low Temperature Storage Test	-40 C × 1000 hours
High Temperature Storage Test	100 C × 1000 hours
Moisture-proof Test	60 C, 90 %RH for 1000 hours
Thermal Shock Test	-40 C × 30 minutes – 100 C × 30 minutes, 100 cycle

### (2) Judgment Criteria of Failure for Reliability Test (Ta=25 C)

Measuring Item	Symbol	Measuring Condition	Judgment Criteria for Failure
Forward Voltage	V <sub>F</sub>	I <sub>F</sub> =480mA	> U × 1.1
Total Luminous Flux	Φ <sub>v</sub>	I <sub>F</sub> =480mA	< S × 0.85

U defines the upper limit of the specified characteristics. S defines the initial value.

Note: Measurement shall be taken between 2 hours and 24 hours, and the test pieces should be returned to the normal ambient conditions after the completion of each test.

CL-L251-MC4L reliability test results will be used for CL-L251-MC4W1-C.

			Approved	Checked	Drawn	Symbol	CITILED
						Name	CL-L251-MC4W1-C
						Drawing No	
-	2010/3/1	Issue of first edition					
Mark	Date	Description	Appro. CITIZEN ELECTRONICS CO.,LTD.				

7. Packing Specifications

(1) Packing

An empty tray is placed on top of a five-tier tray which contain 48 pieces each. The set of six trays is banded together with two rubber bands.

(Smallest packing unit: 240 pieces)

A label with product name, quantity, lot number is placed on the upper empty tray.

Tray (Dimensions: 310 × 200 × 14.6mm / Materials: Electrically conductive PS)

< Packing figure >

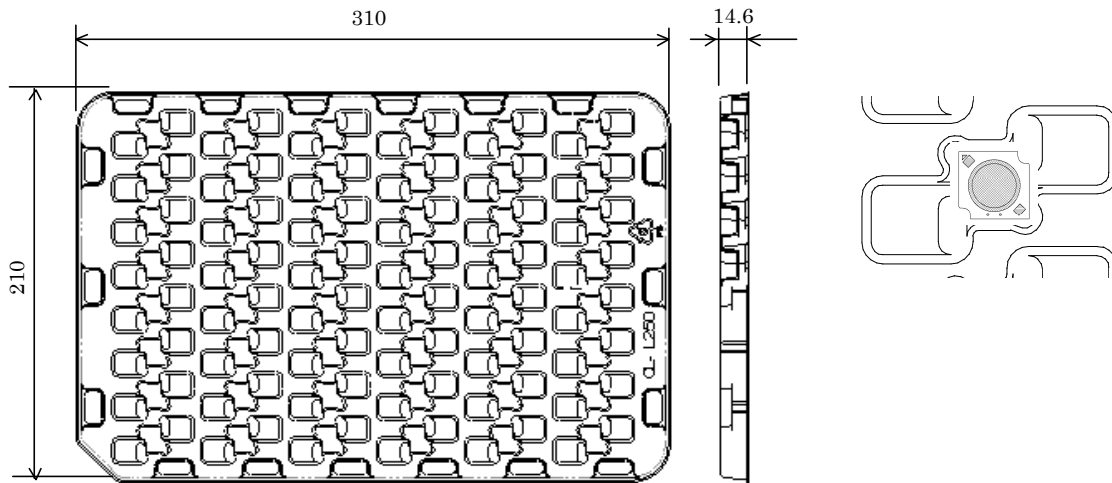

Product 50pcs/tray

< Example of indication label >

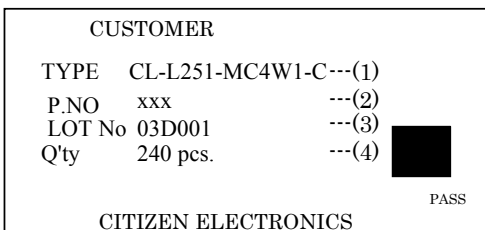

- 1. TYPE e.g. CL-L251-MC4W1-C
- 2. P.No. (Cutomer's P/N) e.g. xxx
- 3. Lot No. e.g. 03D001
  - First letter: Last digit of the year e.g. 0 : year 2010
  - Second letter: Production month e.g. 3 : Mar
- Note: October, November and December are designated by X, Y and Z, respectively.
- Third letter: CE's control number e.g. D001
- 4. Quantity e.g. 240 pieces

			Approved	Checked	Drawn	Symbol	CITILED
						Name	CL-L251-MC4W1-C
						Drawing No	
-	2010/3/1	Issue of first edition					
Mark	Date	Description	Appr.	CITIZEN ELECTRONICS CO.,LTD.			

Precautions

1. Avoid the application of any stress to the lens portion.
2. Avoid any contact by a sharp metal nail or other materials with the lens portion.

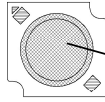

Resin portion (Shaded area)

3. This product should be secured firmly by fastening an M3 screw on both sides of the product. Please be careful not to apply any stress to the product during the clamping operation. As the connection status could vary depending on materials of outer heat sink, please check thoroughly.

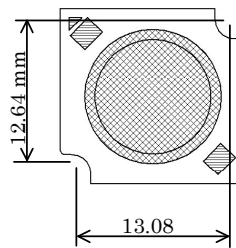
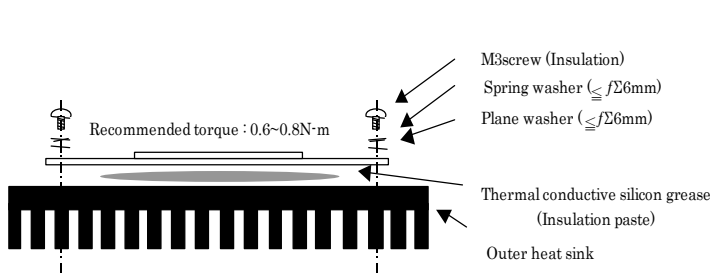

Recommended installation screw pitch

4. Thermal conductive silicone grease should be applied to the whole rear surface so that this product can dissipate heat as a whole. However, the use of insulating paste is strongly recommended in order to avoid short circuit. This product could be bent during the clamping operation if heat grease in sheet form is used. For this reason, it is recommended that grease in paste form is used. In addition, sufficient insulation should be established between heat sink area of LED package and surface of fixture. (\*surface of fixture: exterior of instrument used for dielectric strength test in Electrical Appliance and Material Safety Law.)

5. Handling of static electricity

- These products are sensitive to static electricity charge. Please take measures to prevent any static electricity being produced such as the wearing of a wristband or anti-static gloves when handling this product.
- All devices, equipment and machinery must be properly grounded. It is recommended that precautions be taken against surge voltage to the equipment that mounts the LEDs.
- ESD sensitivity of this product is 1000V (HBM, based on JEITA ED-4701/304).
- When inspecting the final products in which LEDs were assembled, it is recommended to check whether the assembled LEDs are damaged by static electricity or not.
- It is easy to find static-damaged LEDs by a light-on test.

<Light-on test criterion>

Condition	Judgmental criterion
$I_F = \text{Max. } 1\text{mA}$	No-lighting in entire block making up parallel circuit is unacceptable

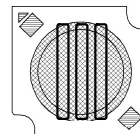

L251 consists of three blocks.

			Approved	Checked	Drawn	Symbol	CITILED
						Name	CL-L251-MC4W1-C
						Drawing No	
-	2010/3/1	Issue of first edition					
Mark	Date	Description	Appro.	CITIZEN ELECTRONICS CO.,LTD.			



# SPECIFICATIONS

9/9

## Precautions (continued)

6. Please be aware that this product should not come into contact with any other parts in assembled status.

### 7. Drive circuit

- A constant current circuit is recommended as a drive circuit.  
And when two or more LED packages are connected, the series connection between each package is recommended.
- Please design a circuit that prevents any reverse voltage (excess current) from being applied to this product instantaneously when the circuit is ON or OFF.

### 8. Heat generation

- As this product is designed with consideration of the heat release property of module, a heat release design is required to use this product efficiently.  
Please ensure that heat generation is not in excess of the absolute maximum rating. (Refer to 4-1 Performance)
- Factors responsible for an increase in temperature include heat generation attributed to ambient temperature conditions or power dissipation. Thus, drive conditions should be taken into consideration, depending on ambient temperature (Ta).

### 9. Recommended soldering

- Soldering operation should be performed within 3.5 seconds per land using a soldering iron of 40W or lower. The temperature of a soldering iron should be adjusted 350C or lower.
- No external force is applied to sealing resin during soldering operation.
- Please do not handle a product until it returns to a normal temperature.  
Note: This product is not adaptable to reflow process.

### 10. Other

- This product complies with RoHS directives.
- This product is intended for the application in general electronic devices (such as office automation equipment, communication devices, audio-video equipment, home electrical appliances, measurement hardware and others).  
In cases where this product is used for the applications that requires high reliability or could directly affect human life or health due to failure or malfunction (aerospace hardware, medical equipment, atomic control equipment and others), please consult with our sales representatives beforehand.
- Our warranty does not cover situations where this product undergoes secondary fabrication such as changes in shape.
- An agreement of formal product specifications is required prior to mass production.
- The specifications and appearance of this product are subject to change without advanced notice.

			Approved	Checked	Drawn	Symbol	CITILED
						Name	CL-L251-MC4W1-C
						Drawing No	
-	2010/3/1	Issue of first edition					
Mark	Date	Description	Appro. CITIZEN ELECTRONICS CO.,LTD.				