

RIGHT ANGLE T-100 (3 mm)

Diffused

PACKAGE DIMENSIONS

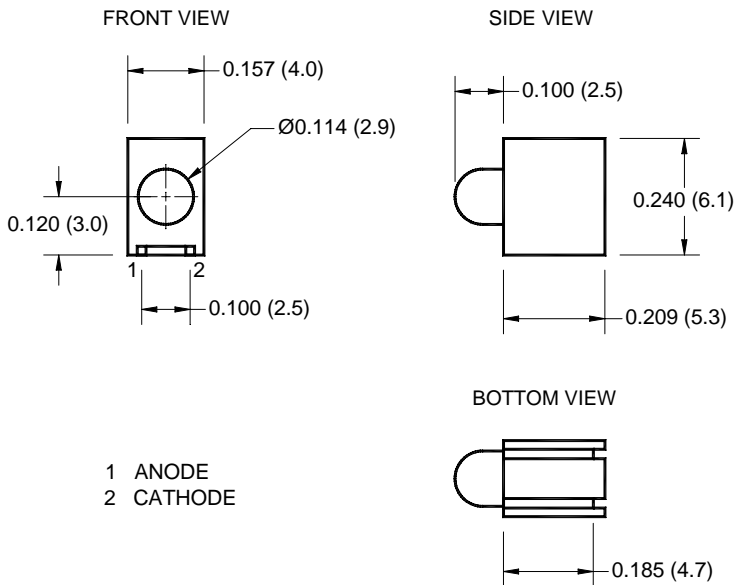

NOTE:

Dimensions for all drawings are in inches (mm).

HER	HLMP-1700.MP4C
YELLOW	HLMP-1719.MP4C
GREEN	HLMP-1790.MP4C

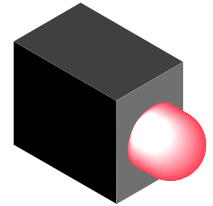

FEATURES

- Standard 100 mil. lead spacing
- Solid state reliability
- Diffused
- Low current (2 mA)

DESCRIPTION

These T-100 right angle lamps have a viewing angle of 40°.

ABSOLUTE MAXIMUM RATINGS (T_A = 25°C unless otherwise specified)

Parameter	Symbol	Rating	Unit
Operating Temperature	T _{OPR}	-40 to +85	°C
Storage Temperature	T _{STG}	-40 to +100	°C
Lead Soldering Time	T _{SOL}	260 for 3 sec	°C
Continuous Forward Current	I _F	30	mA
Peak Forward Current (f = 1.0 KHz, Duty Factor = 1/10)	I _F	160	mA
Reverse Voltage	V _R	5	V
Power Dissipation	P _D	85	mW

ELECTRICAL / OPTICAL CHARACTERISTICS (T_A = 25°C)

Part Number	HLMP-1700.MP4C	HLMP-1719.MP4C	HLMP-1790.MP4C	Condition
Luminous Intensity (mcd)				I _F = 2mA
Minimum	1	1	1	
Typical	2	2	2	
Forward Voltage (V)				I _F = 2mA
Maximum	2.7	2.7	2.7	
Typical	1.9	1.9	1.9	
Peak Wavelength (nm)	635	585	565	I _F = 2mA
Spectral Line Half Width (nm)	45	20	30	I _F = 2mA
Viewing Angle (°)	40	40	40	I _F = 2mA

HER	HLMP-1700.MP4C
YELLOW	HLMP-1719.MP4C
GREEN	HLMP-1790.MP4C

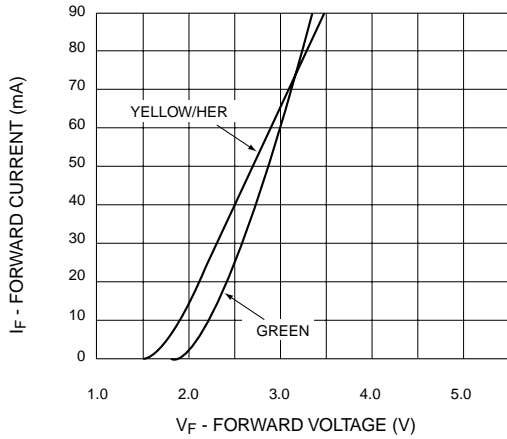

Fig. 1 Forward Current vs. Forward Voltage

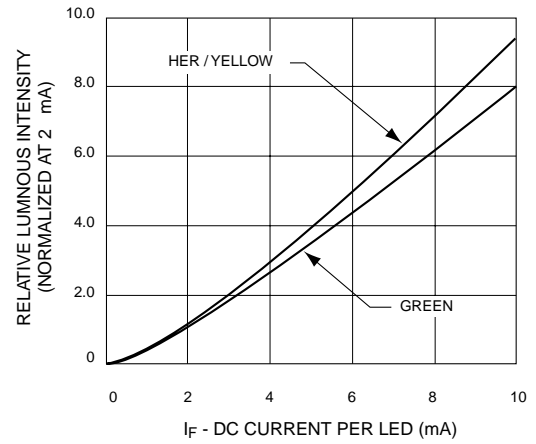

Fig. 2 Relative Luminous Intensity vs. DC Forward Current

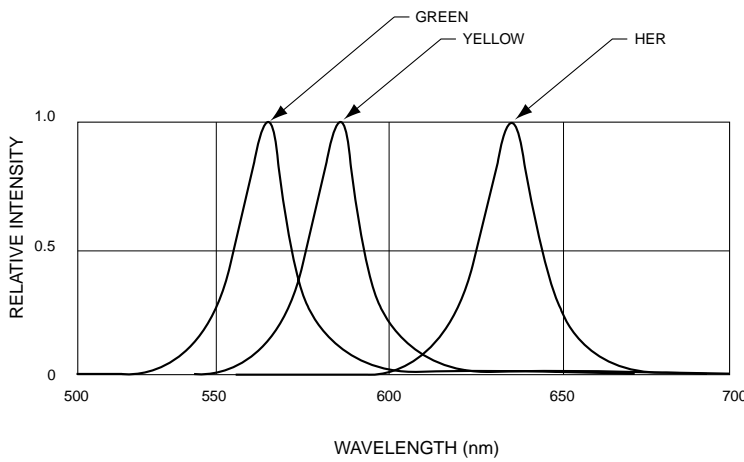

Fig. 3 Relative Intensity vs. Peak Wavelength

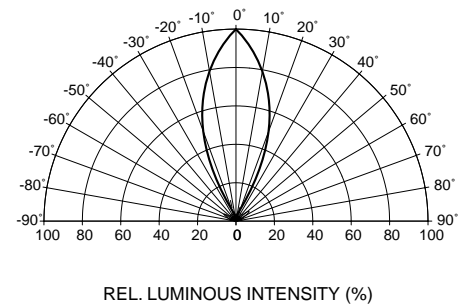

Fig. 4 Radiation Diagram

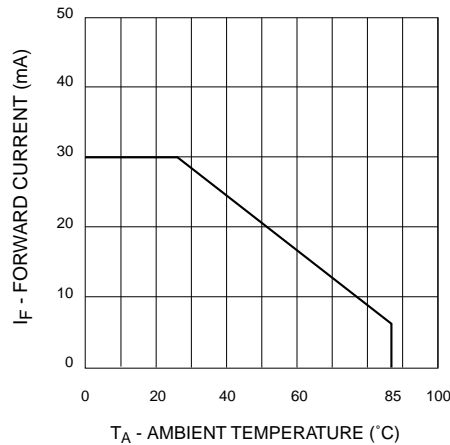

Fig. 5 Current Derating Curve

DISCLAIMER

FAIRCHILD SEMICONDUCTOR RESERVES THE RIGHT TO MAKE CHANGES WITHOUT FURTHER NOTICE TO ANY PRODUCTS HEREIN TO IMPROVE RELIABILITY, FUNCTION OR DESIGN. FAIRCHILD DOES NOT ASSUME ANY LIABILITY ARISING OUT OF THE APPLICATION OR USE OF ANY PRODUCT OR CIRCUIT DESCRIBED HEREIN; NEITHER DOES IT CONVEY ANY LICENSE UNDER ITS PATENT RIGHTS, NOR THE RIGHTS OF OTHERS.

LIFE SUPPORT POLICY

FAIRCHILD'S PRODUCTS ARE NOT AUTHORIZED FOR USE AS CRITICAL COMPONENTS IN LIFE SUPPORT DEVICES OR SYSTEMS WITHOUT THE EXPRESS WRITTEN APPROVAL OF THE PRESIDENT OF FAIRCHILD SEMICONDUCTOR CORPORATION. As used herein:

1. Life support devices or systems are devices or systems which, (a) are intended for surgical implant into the body, or (b) support or sustain life, and (c) whose failure to perform when properly used in accordance with instructions for use provided in the labeling, can be reasonably expected to result in a significant injury of the user.
2. A critical component in any component of a life support device or system whose failure to perform can be reasonably expected to cause the failure of the life support device or system, or to affect its safety or effectiveness.