

3 AMP HIGH RELIABILITY FAST RECOVERY DIODES

FEATURES

- PROPRIETARY **SOFT GLASS[®]** JUNCTION PASSIVATION FOR SUPERIOR RELIABILITY AND PERFORMANCE
- VOID FREE VACUUM DIE SOLDERING FOR MAXIMUM MECHANICAL STRENGTH AND HEAT DISSIPATION (Solder Voids: Typical $\leq 2\%$, Max. $\leq 10\%$ of Die Area)
- EXTREMELY LOW LEAKAGE AT HIGH TEMPERATURES
- LOW FORWARD VOLTAGE DROP
- 3A at $T_A = 55^\circ\text{C}$ WITH NO THERMAL RUNAWAY

MECHANICAL DATA

- Case: JEDEC DO-27 molded epoxy (U/L Flammability Rating 94V-0)
- Terminals: Plated axial leads
- Soldering: Per MIL-STD 202 Method 208 guaranteed
- Polarity: Color band denotes cathode
- Mounting Position: Any
- Weight: 0.02 Ounces (0.7 Grams)

RoHS COMPLIANT

MECHANICAL SPECIFICATION

ACTUAL SIZE OF DO-27 PACKAGE

SERIES RGP300 - RGP310

DO - 27

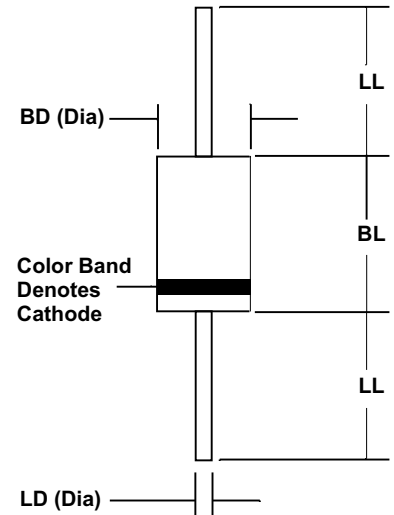
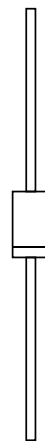

Sym	Minimum		Maximum	
	In	mm	In	mm
BL			0.365	9.28
BD			0.205	5.2
LL	1.00	25.4		
LD	0.048	1.2	0.052	1.3

MAXIMUM RATINGS & ELECTRICAL CHARACTERISTICS

Ratings at 25 °C ambient temperature unless otherwise specified.
 Single phase, half wave, 60Hz, resistive or inductive load.
 For capacitive loads, derate current by 20%.

PARAMETER (TEST CONDITIONS)	SYMBOL	RATINGS								UNITS
		RGP 300	RGP 301	RGP 302	RGP 304	RGP 306	RGP 308	RGP 310		
Series Number										
Maximum DC Blocking Voltage	V_{RM}	50	100	200	400	600	800	1000		VOLTS
Maximum RMS Voltage	V_{RMS}	35	70	140	280	420	560	700		
Maximum Peak Recurrent Reverse Voltage	V_{RRM}	50	100	200	400	600	800	1000		
Average Forward Rectified Current @ $T_A = 55^\circ\text{C}$, Lead length = 0.375 in. (9.5 mm)	I_o	3								AMPS
Peak Forward Surge Current (8.3 mSec single half sine wave superimposed on rated load)	I_{FSM}	200								
Maximum Forward Voltage at 3 Amps DC	V_{FM}	1.2								VOLTS
Maximum Reverse Recovery Time ($I_F=0.5A$, $I_R=1A$, $I_{RR}=0.25A$)	T_{RR}	150			250		500 (Note 3)			nS
Maximum Average DC Reverse Current At Rated DC Blocking Voltage	I_{RM}	2								μA
		100								
Typical Junction Capacitance (Note 2)	C_J	40								pF
Operating and Storage Temperature Range	T_J, T_{STG}	-65 to +175								$^\circ\text{C}$

NOTES: (1) Lead length = 0.375 in. (9.5 mm)
 (2) Measured at 1MHz & applied reverse voltage of 4 volts
 (3) 300 nS available - consult with factory

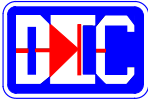

3 AMP HIGH RELIABILITY FAST RECOVERY DIODES

RATING & CHARACTERISTIC CURVES FOR SERIES RGP300 - RGP310

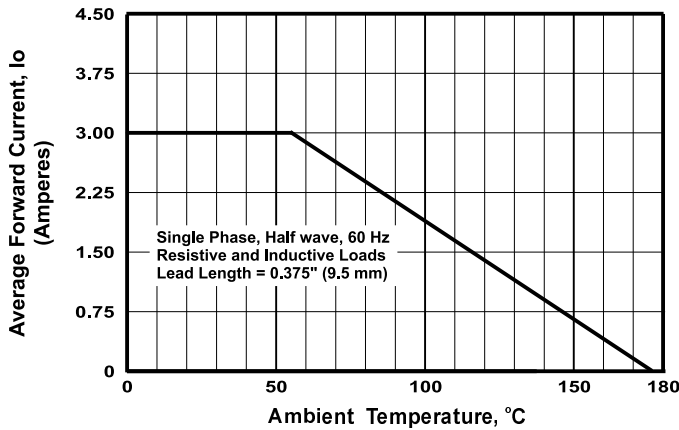

FIGURE 1. FORWARD CURRENT DERATING CURVE

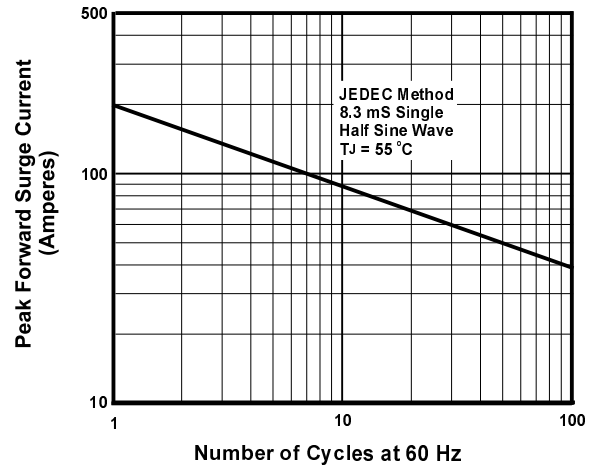

FIGURE 2. MAXIMUM NON-REPETITIVE SURGE CURRENT

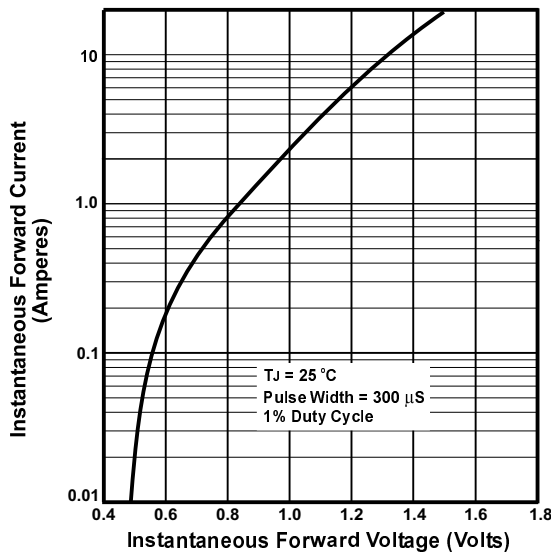

FIGURE 3. TYPICAL FORWARD CHARACTERISTIC

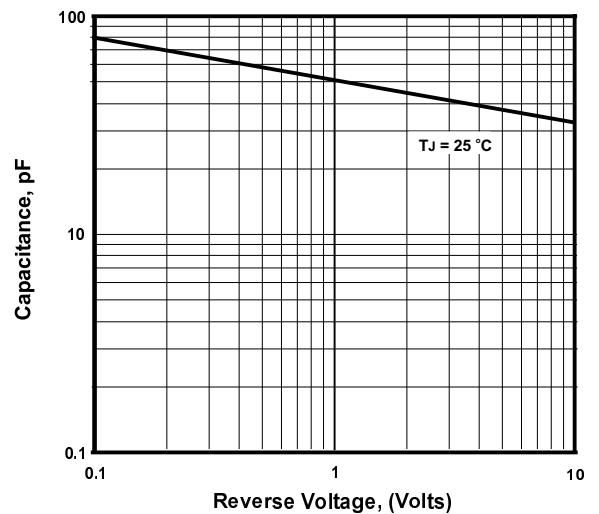

FIGURE 4. TYPICAL JUNCTION CAPACITANCE

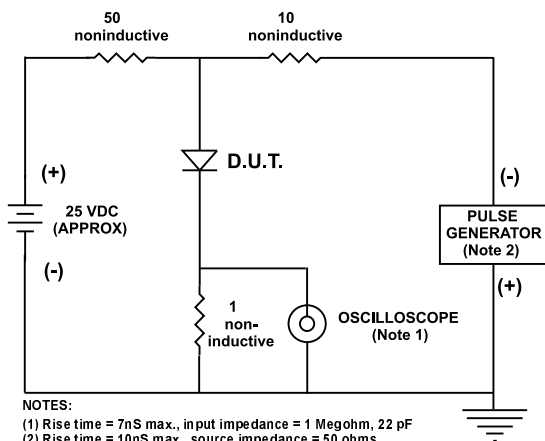

FIGURE 5. REVERSE RECOVERY TEST SETUP AND TIME CHARACTERISTIC