

# Ceramic Resonators

SMD

4.0 to 50MHz

CCR(Built-in load capacity/External load capacity) series

Issue date: July 2010

- All specifications are subject to change without notice.
  - Conformity to RoHS Directive: This means that, in conformity with EU Directive 2002/95/EC, lead, cadmium, mercury, hexavalent chromium, and specific bromine-based flame retardants, PBB and PBDE, have not been used, except for exempted applications.
-

# Ceramic Resonators(SMD)

## CCR Series

Conformity to RoHS Directive

### FEATURES

- The CCR series are thin-type ceramic chip resonators. Thickness shear mode or 3rd over-tone thickness expansion mode element are used for both the 4.0 to 11.0MHz band and the 16.0 to 50.0MHz band.
- Products with built-in loading capacitance have piezoelectric elements that are mounted onto a capacity-forming dielectric substrate. This eliminates the need for external capacitors, thus simplifying circuit requirements.
- Optimization of the temperature characteristics of both the piezoelectric element and dielectric materials has resulted in stable oscillating frequency.
- Corresponds to reflow soldering. Moreover, it is possible to correspond Pb-free soldering. (260°C, 10sec. max.) Packaging style is emboss taping.
- Setting or matching of oscillating frequency which correspond to new models, application IC or custom IC are also available, please contact TDK.

### TEMPERATURE RANGES

Operating/Storage	-40 to +85°C
-------------------	--------------

### RECOMMENDED SOLDERING CONDITIONS

#### REFLOW SOLDERING

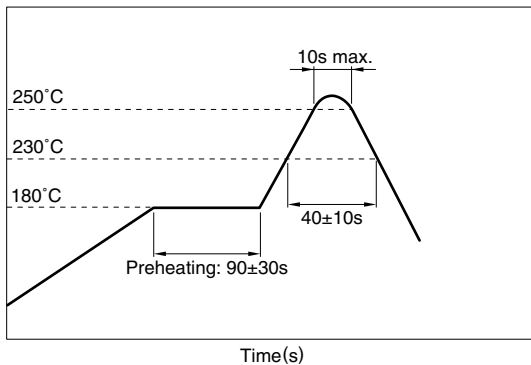

### PRODUCT IDENTIFICATIONS

CCR	20.0	MXC7	□□□	□□	□□	□□	T□
(1)	(2)	(3)	(4)	(5)	(6)	(7)	(8)

#### (1) Series name

CCR	Ceramic resonator(SMD)
-----	------------------------

#### (2) Oscillating frequency

#### (3) Production type and dimensions

Symbol	Oscillating frequency range (MHz)	Loading capacitors	Dimensions L×W (mm)
MUC8	4.0 to 7.99	Internal	4.0×2.0
MXC8	8.0 to 11.0	Internal	3.2×1.3
MX7	16.0 to 50.0	External	2.5×2.0
MXC7	16.0 to 50.0	Internal	2.5×2.0
MYC7	24.0 to 50.0	Internal	2.0×1.6

#### (4) Initial oscillating frequency tolerance

Symbol	MUC8	MXC8	MXC7/MX7/MYC7
Non	±0.5%	±0.5%	±0.5%
A	±0.3%	±0.3%	±0.3%
A2	—	—	±0.2%
A15	—	—	±0.15%
Others	Custom made		

#### (5) Oscillating frequency correlation

Non	Non correlation for TDK standard
F	Custom made
F1	Custom made
F2	Custom made
Others	Custom made

#### (6) Built-in loading capacitance

Symbol	MUC8	MXC8	MXC7
Non	Standard(27pF)	Standard(18pF)	Standard(8/9pF)
J	—	—	11.5pF
J1	—	—	6/4pF
J2	—	—	2pF
Others	Custom made		

#### (7) Product's thickness

Non	Standard
N	Custom made
N1	Custom made
N2	Custom made
Others	Custom made

#### (8) Taping style

Symbol	MUC8	MXC8	MXC7/MX7	MYC7
T	2,000pieces/ reel (ø180mm)	2,000pieces/ reel (ø180mm)	2,000pieces/ reel (ø180mm)	—
T1	—	—	3,000pieces/ reel (ø180mm)	3,000pieces/ reel (ø180mm)
T2	—	—	4,000pieces/ reel (ø180mm)	—
T3	—	—	10,000pieces/ reel (ø330mm)	—

• Conformity to RoHS Directive: This means that, in conformity with EU Directive 2002/95/EC, lead, cadmium, mercury, hexavalent chromium, and specific bromine-based flame retardants, PBB and PBDE, have not been used, except for exempted applications.

• All specifications are subject to change without notice.

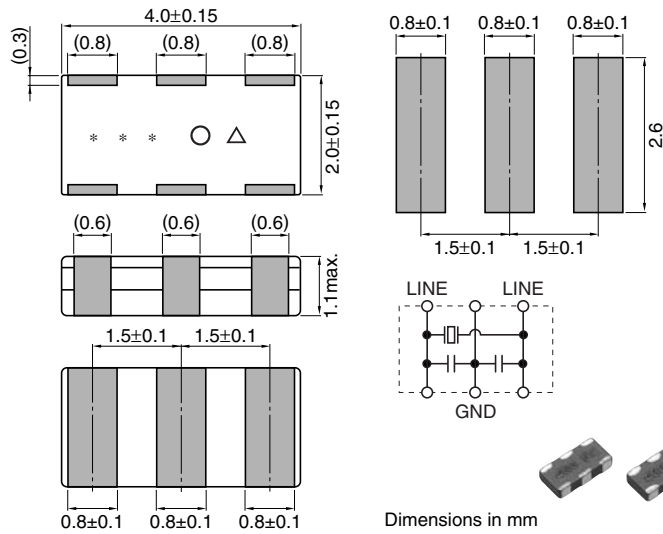
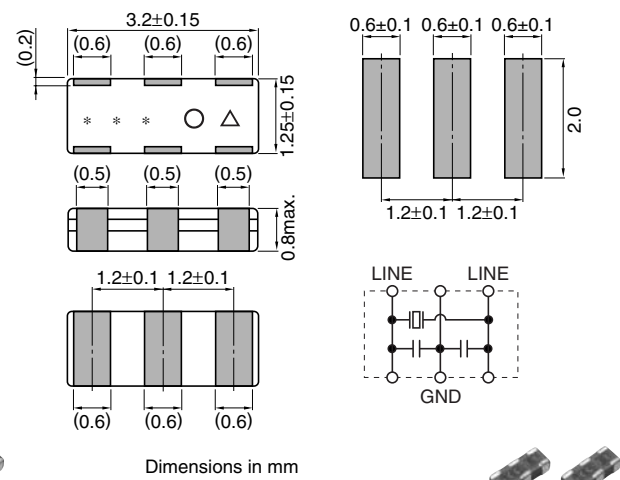
**SHAPES AND DIMENSIONS/RECOMMENDED PC BOARD PATTERNS**
**MUC8 TYPE**
**FUNDAMENTAL WAVE MODE: 4.0 to 7.99MHz/**
**BUILT-IN LOAD CAPACITY**

**MXC8 TYPE**
**FUNDAMENTAL WAVE MODE: 8.0 to 11.00MHz/**
**BUILT-IN LOAD CAPACITY**

**MUC8 TYPE**

Part No.	Oscillating frequency Fosc (MHz)	Resonant impedance Z <sub>0</sub> (Ω)max.	Initial Fosc tolerance* (%)max.	Built-in load capacity(pF)		T (mm)max.
				CL <sub>1</sub>	CL <sub>2</sub>	
CCR4.0MUC8T	4.000	40	±0.5/0.3	27	27	1.1
CCR4.19MUC8T	4.194	40	±0.5/0.3	27	27	1.1
CCR4.91MUC8T	4.915	40	±0.5/0.3	27	27	1.1
CCR5.0MUC8T	5.000	40	±0.5/0.3	27	27	1.1
CCR6.0MUC8T	6.000	40	±0.5/0.3	27	27	1.1

• These are representative characteristics. Oscillating frequencies and built-in load capacity values other than these shown here can be supported.  
\* ±0.5% is standard. Also available for custom made, please contact TDK.

**MXC8 TYPE**

Part No.	Oscillating frequency Fosc (MHz)	Resonant impedance Z <sub>0</sub> (Ω)max.	Initial Fosc tolerance* (%)max.	Built-in load capacity(pF)		T (mm)max.
				CL <sub>1</sub>	CL <sub>2</sub>	
CCR8.0MXC8T	8.000	40	±0.5/0.3	18	18	0.8
CCR8.38MXC8T	8.380	40	±0.5/0.3	18	18	0.8
CCR10.0MXC8T	10.000	40	±0.5/0.3	18	18	0.8
CCR11.0MXC8T	11.000	40	±0.5/0.3	18	18	0.8

• These are representative characteristics. Oscillating frequencies and built-in load capacity values other than these shown here can be supported.  
\* ±0.5% is standard. Also available for custom made, please contact TDK.

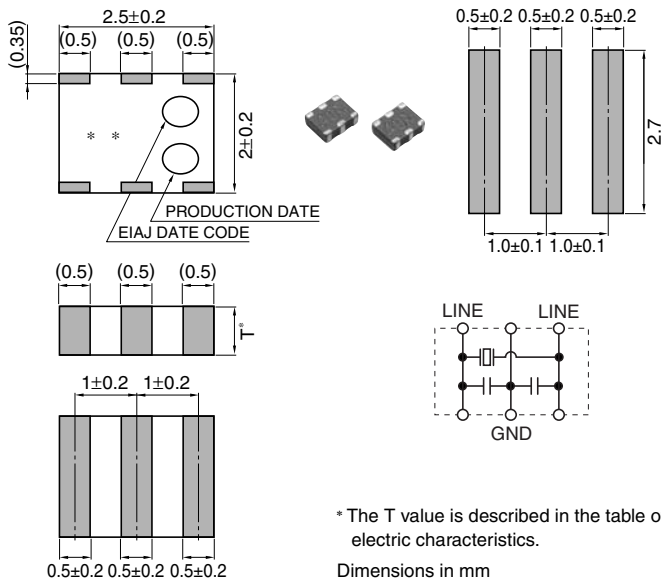
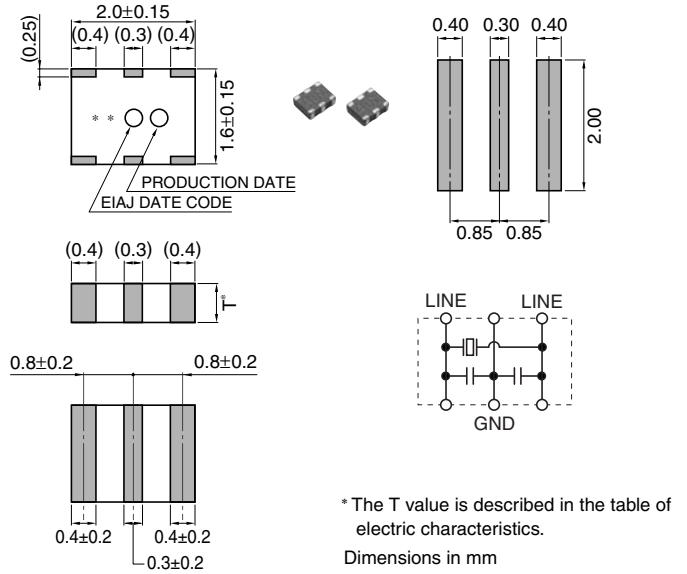
**MXC7 TYPE**
**THIRD HARMONIC MODE: 16.0 to 50.0MHz/  
BUILT-IN LOAD CAPACITY**
**MYC7 TYPE**
**THIRD HARMONIC MODE: 24.0 to 50.0MHz/  
BUILT-IN LOAD CAPACITY**
**MXC7 TYPE**

Part No.	Oscillating frequency Fosc (MHz)	Resonant impedance Zo (Ω)max.	Initial Fosc tolerance* (%)max.	Built-in load capacity(pF)		T (mm)
				CL1	CL2	
CCR16.0MXC7T	16.000	70	±0.5/0.3/0.15	10.0	10.0	1.1±0.2
CCR16.93MXC7T	16.934	70	±0.5/0.3/0.15	9.0	9.0	1.1±0.2
CCR18.0MXC7T	18.000	70	±0.5/0.3/0.15	9.0	9.0	1±0.2
CCR20.0MXC7T	20.000	40	±0.5/0.3/0.15	9.0	9.0	1±0.2
CCR22.58MXC7T	22.580	40	±0.5/0.3/0.15	9.0	9.0	1±0.2
CCR24.0MXC7T	24.000	40	±0.5/0.3/0.15	9.0	9.0	1±0.2
CCR25.0MXC7T	25.000	40	±0.5/0.3/0.15	8.0	8.0	0.9±0.2
CCR30.0MXC7T	30.000	40	±0.5/0.3/0.15	8.0	8.0	0.9±0.2
CCR32.0MXC7T	32.000	40	±0.5/0.3/0.15	8.0	8.0	0.8±0.2
CCR33.33MXC7T	33.333	40	±0.5/0.3/0.15	8.0	8.0	0.8±0.2
CCR33.86MXC7T	33.868	40	±0.5/0.3/0.15	8.0	8.0	0.8±0.2
CCR34.57MXC7T	34.570	40	±0.5/0.3/0.15	8.0	8.0	0.8±0.2
CCR40.0MXC7T	40.000	40	±0.5/0.3/0.15	8.0	8.0	0.8±0.2
CCR48.0MXC7T	48.000	40	±0.5/0.3/0.15	8.0	8.0	0.8±0.2
CCR50.0MXC7T	50.000	40	±0.5/0.3/0.15	8.0	8.0	0.8±0.2

• These are representative characteristics. Oscillating frequencies and built-in load capacity values other than these shown here can be supported.  
\* ±0.5% is standard. Also available for custom made, please contact TDK.

**MYC7 TYPE**

Part No.	Oscillating frequency Fosc (MHz)	Resonant impedance Zo (Ω)max.	Initial Fosc tolerance* (%)max.	Built-in load capacity(pF)		T (mm)
				CL1	CL2	
CCR24.0MYC7T1	24.000	40	±0.5/0.3/0.15	7.0	7.0	0.7±0.2
CCR25.0MYC7T1	25.000	40	±0.5/0.3/0.15	7.0	7.0	0.7±0.2
CCR30.0MYC7T1	30.000	40	±0.5/0.3/0.15	7.0	7.0	0.7±0.2
CCR33.33MYC7T1	33.333	40	±0.5/0.3/0.15	7.0	7.0	0.7±0.2
CCR33.86MYC7T1	33.868	40	±0.5/0.3/0.15	7.0	7.0	0.7±0.2
CCR40.0MYC7T1	40.000	40	±0.5/0.3/0.15	7.0	7.0	0.8±0.2
CCR48.0MYC7T1	48.000	40	±0.5/0.3/0.15	7.0	7.0	0.8±0.2

• These are representative characteristics. Oscillating frequencies and built-in load capacity values other than these shown here can be supported.  
\* ±0.5% is standard. Also available for custom made, please contact TDK.

## MX7 TYPE

### THIRD HARMONIC MODE: 16.0 to 50.0MHz/EXTERNAL LOAD CAPACITY

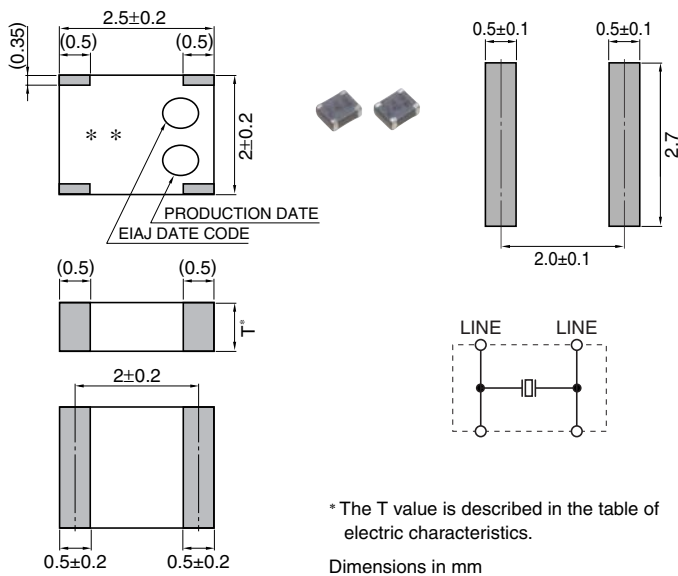

## MX7 TYPE

Part No.	Oscillating frequency Fosc (MHz)	Resonant impedance Z <sub>0</sub> (Ω)max.	Initial Fosc tolerance* (%)max.	Built-in load capacity(pF)		T (mm)
				CL <sub>1</sub>	CL <sub>2</sub>	
CCR16.0MX7T	16.000	70	±0.5/0.3/0.15	—	—	1.1±0.2
CCR16.93MX7T	16.934	70	±0.5/0.3/0.15	—	—	1.1±0.2
CCR18.0MX7T	18.000	70	±0.5/0.3/0.15	—	—	1±0.2
CCR20.0MX7T	20.000	40	±0.5/0.3/0.15	—	—	1±0.2
CCR22.58MX7T	22.580	40	±0.5/0.3/0.15	—	—	1±0.2
CCR24.0MX7T	24.000	40	±0.5/0.3/0.15	—	—	1±0.2
CCR25.0MX7T	25.000	40	±0.5/0.3/0.15	—	—	0.9±0.2
CCR30.0MX7T	30.000	40	±0.5/0.3/0.15	—	—	0.9±0.2
CCR32.0MX7T	32.000	40	±0.5/0.3/0.15	—	—	0.8±0.2
CCR33.33MX7T	33.333	40	±0.5/0.3/0.15	—	—	0.8±0.2
CCR33.86MX7T	33.868	40	±0.5/0.3/0.15	—	—	0.8±0.2
CCR34.57MX7T	34.570	40	±0.5/0.3/0.15	—	—	0.8±0.2
CCR40.0MX7T	40.000	40	±0.5/0.3/0.15	—	—	0.8±0.2
CCR48.0MX7T	48.000	40	±0.5/0.3/0.15	—	—	0.8±0.2
CCR50.0MX7T	50.000	40	±0.5/0.3/0.15	—	—	0.8±0.2

• These are representative characteristics. Oscillating frequencies and built-in load capacity values other than these shown here can be supported.

\* ±0.5% is standard. Also available for custom made, please contact TDK.

**TYPICAL ELECTRICAL CHARACTERISTICS**

**OSCILLATING FREQUENCY DRIFT OVER TEMPERATURE**

MUC8/MXC8:  $\pm 0.3\%$  / -40 to +85°C (Standard)

CCR8.0MXC8

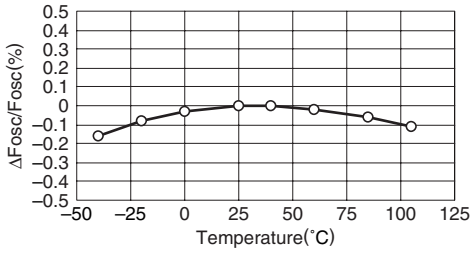

**OSCILLATING FREQUENCY AGING**

MUC8/MXC8:  $\pm 0.2\%$  / 10years (Standard)

CCR8.0MXC8

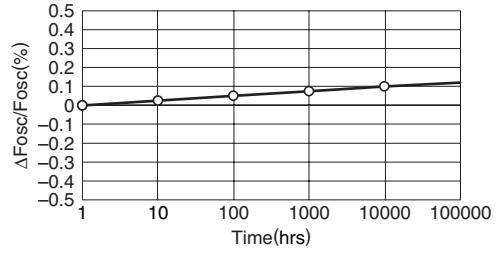

MXC7:  $\pm 0.2\%$  / -40 to +85°C (Standard)

CCR48.0MXC7

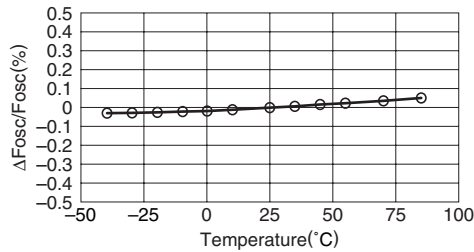

MXC7:  $\pm 0.1\%$  / 10years (Standard)

CCR48.0MXC7

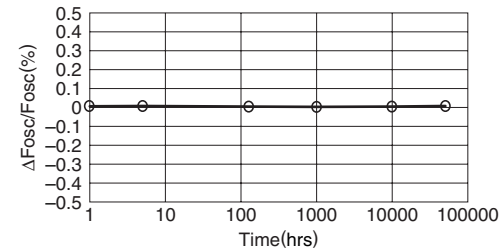

MYC7:  $\pm 0.2\%$  / -40 to +85°C (Standard)

CCR48.0MYC7T1

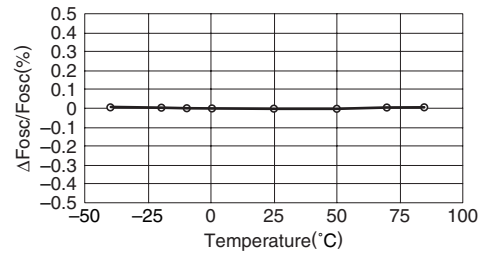

MYC7 :  $\pm 0.1\%$  / 10years (Standard)

CCR48.0MYC7T1

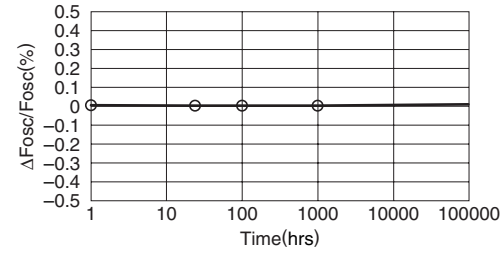

## OSCILLATING FREQUENCY-TEMPERATURE CHARACTERISTIC MEASURING CIRCUIT

### MUC8/MXC8 TYPE 4.0 to 9.99MHz

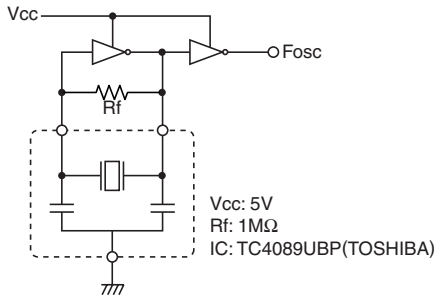

### MXC8 TYPE 10.0 to 11.0MHz

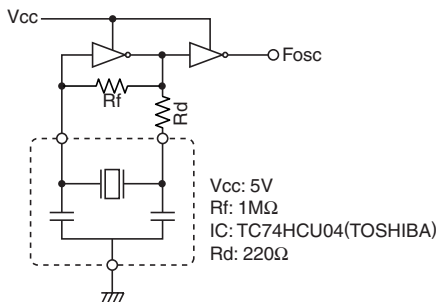

### MXC7 TYPE 16.0 to 50.0MHz

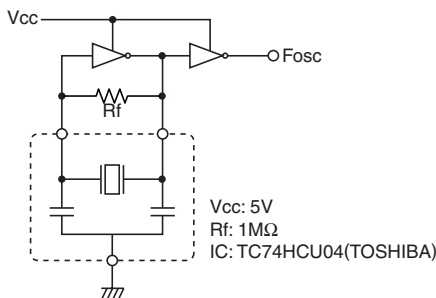

### MX7 TYPE 16.0 to 50.0MHz

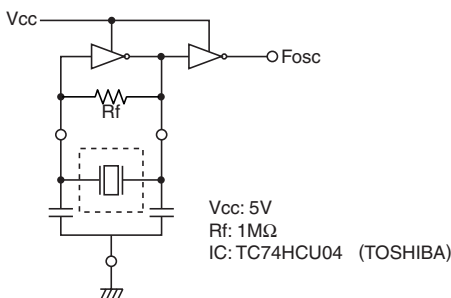

### MYC7 TYPE 24.0 to 50.0MHz

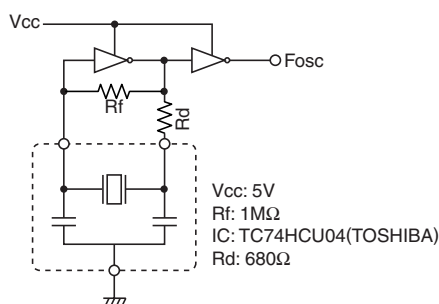

## RELIABILITY AND TEST CONDITIONS

The following test items are satisfied.

- (1) Oscillating frequency change: Within  $\pm 0.25\%$
- (2) Resonant resistance change: Within  $\pm 10\Omega$
- (3) Appearance; serious abnormalities not to exist.

Test items	Test conditions
Low temperature storage	Temperature: $-40\pm 3^\circ\text{C}$ Time: 1000h
High temperature storage	Temperature: $+85\pm 2^\circ\text{C}$ Time: 1000h
Loading humidity resistance	Humidity: 90 to 95(%RH) Temperature: $60\pm 2^\circ\text{C}$ Time: 1000h
Thermal shock	$-40^\circ\text{C}$ (30min), $85^\circ\text{C}$ (30min) x 100 cycles
Soldering heat resistance	Solder temperature: peak $260^\circ\text{C}$ , 10s reflow
Drop	Drop 3 times onto the concrete from a height of 1m
Vibration	Frequency: $10 \leftrightarrow 55 \leftrightarrow 10\text{Hz/min}$ Amplitude: 1.5mm X, Y and Z directions for 2h each
Board bend test	Solder this product onto a glass epoxy board (L100×W40×T1.6mm), press it by up to 1mm in 1mm/s and keep it for 5sec.