



AWT6201
GSM850/GSM900/DCS/PCS
Quad Band PowerPlexer™
with Integrated Power Control

Advanced Product Information - Rev 0.7

FEATURES

- ANADIGICS developed technologies (InGaP HBT/pHEMT/IPP)
- Proven high volume low cost laminate/overmold technology
- Integrated Power Control (CMOS)
- Integrated PA/SW/LPF
- High Gain InGaP HBT PAs
- Low loss receive paths
- High isolation switch (TX to RX, RX on/off)
- Fully compliant GSM harmonic performance
- ESD protected antenna port (12kV)
- Small footprint (10.5mm x 11.0mm x 1.55mm)
- GPRS capable (class 12)
- Power control range >50dB

The module requires only the most basic RF decoupling, all the RF ports are 50Ω, and interfaces directly with the baseband power control DAC. The solution includes integrated power control, two dual band power amplifiers to support GSM850/900/DCS/PCS, harmonic filtering and RX/TX switching.

The power amplifiers support class 12 GPRS, 4 TX slots at 50% duty cycle, using three stage InGaP HBT PAs. The pHEMT switches support 4 RX ports to interface with external RX SAW filters and the filtering is achieved using integrated passives technology.

The integrated power control scheme reduces the number of external components associated with a power control function, and facilitates fast and easy production calibration. The power control range is typically 55dB.

APPLICATIONS

- Quad band handsets and PDAs
- Configurable for Tri Band/UMTS handsets

PRODUCT DESCRIPTION

The AWT6201 is the second generation GSM PowerPlexer™. It has been developed to minimize time to market for GSM handset/PDA designers.

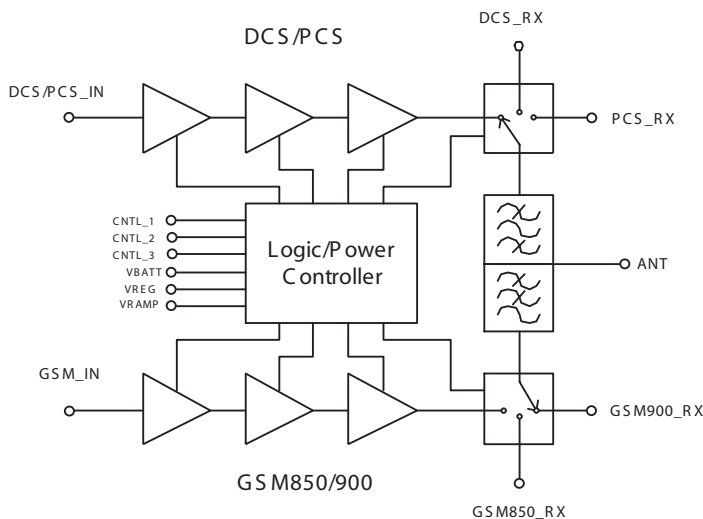

Figure 1: Functional Block Diagram

AWT6201

ELECTRICAL CHARACTERISTICS

Table 1: Absolute Minimum and Maximum Ratings

PARAMETER	MIN	MAX	UNIT
Supply Voltage (VCC)		+7	V
Input Power (RFIN)		+11	dBm
Power Control Voltage (VRAMP)		1.8	V
Storage Temperature (TSTG)	-55	150	°C
Maximum Reflow Temperature		240	°C

Exceeding the absolute maximum ratings can cause permanent damage to the device. These are absolute stress ratings only. Functional operation of the device is not implied at these or any other conditions in excess of those given in the operations sections of this data sheet. Exposure to maximum ratings for extended periods can adversely affect device reliability.

Table 2: ESD Ratings

PARAMETER	METHOD	RATING	UNIT
ESD Threshold Voltage (Antenna Port)	HBM	12	kV
ESD Threshold Voltage (Control Inputs)	HBM	1	kV
ESD Threshold Voltage (RF Inputs)	HBM	250	V
ESD Threshold Voltage (RX Ports)	HBM	300	V

Although protection circuitry has been designed into this device, proper precautions should be taken to avoid exposure to electrostatic discharge (ESD) during handling and mounting. Human body model HBM employed is resistance = 1500Ω, capacitance = 100pF.

Table 3: Logic Level Definitions

Test Conditions: Vcc = 3.0 to 4.8V, Tc = 25 ± 3°C

SIGNAL	MIN	TYP	MAX	UNIT
Logic High	1.7		3	V
Logic Low	0		0.5	V
Input bias current			10	μA

Table 4: Operating Conditions and Supply Currents

PARAMETER	MIN	TYP	MAX	UNIT	COMMENTS
Supply Voltage (VBATT)	3.0	3.5	4.8	V	
Regulated Voltage (VREG)	2.7	2.85	3.0	V	
Regulated Current (IREG)		7	10	mA	TX mode enabled
Regulated Current (IREG)		10	30	μA	RX mode enabled
Power Down Current (VBATT = 4.8V)	0		10	μA	
RX Current (VBATT = 4.8V)	0		30	μA	
Control Voltage (VRAMP)	0.2		1.6	V	
Control Voltage for minimum POUT (VRAMP_MIN)		0.2	0.25	V	
VRAMP input capacitance		15	20	pF	
GSM850/900 module efficiency (VRAMP = 1.6V, VBATT = 3.5V, PIN = 2dBm)		40		%	(PA+Switch+Filter)
DCS/PCS module efficiency (VRAMP = 1.6V, VBATT = 3.5V, PIN = 2dBm)		34		%	(PA+Switch+Filter)
Case Temperature (Tc)	-20		85	°C	
Duty Cycle			50	%	

Parametric performance is guaranteed under specified operating conditions.

Table 5: Receiver Specification

Test Conditions: Mode = RX (see control table), VBATT = 3.5V, ZIN = ZOUT = 50Ω, Tc = 25 ± 3°C

PARAMETER	MIN	TYP	MAX	UNIT	Comments
GSM850/900 Insertion loss		1.3	1.5	dB	F _{IN} = 869 to 960MHz, VBATT = 3.0 to 4.8V, Tc = -20 to +85°C
DCS/PCS Insertion loss		1.2	1.5	dB	F _{IN} = 1805 to 1990MHz, VBATT = 3.0 to 4.8V, Tc = -20 to +85°C
Receiver Return loss	15			dB	F _{IN} = 869 to 960MHz
	15			dB	F _{IN} = 1805 to 1990MHz
Receiver Isolation ANT to RX_OFF	25			dB	F _{IN} = 869 to 960MHz
	25			dB	F _{IN} = 1805 to 1990MHz
TX Power at RX ports		6	8	dBm	F _{IN} = 915MHz, P _{OUT} = 33.2dBm
		3	5	dBm	F _{IN} = 1910MHz, P _{OUT} = 30.4dBm

AWT6201

Table 6: GSM850/900 Electrical Specification

Test Conditions: Mode = GSM_TX_EN, VBATT = 3.5V, ZIN = ZOUT = 50Ω, TC = 25 ± 3°C, PIN = 2dBm,

PWIDTH = 1154μs, Duty Cycle = 25%

PARAMETER	MIN	TYP	MAX	UNITS	COMMENTS
Frequency (FIN)	824 880		849 915	MHz MHz	
Input Power (PIN)	0	2	4	dBm	
Output Power (POUT)	33.2	33.8		dBm	VRAMP = 1.6V
Degraded Output Power	30.7	31.7		dBm	VBATT = 3.0 V, VRAMP = 1.6V, PIN = 0dBm, TC = 85°C
Forward Isolation (1)		-55	-51	dBm	PIN = 4dBm, VBATT = 3 to 4.8V Mode = GSM900_RX_EN or GSM850_RX_EN, see control table
Forward Isolation (2)		-25	-10	dBm	VRAMP = 0.2V, PIN = 4dBm, VBATT = 3 to 4.8V Mode = GSM_TX_EN, see control table
Harmonic 2 nd 3f _o to 12.75 GHz		-38 -37	-34 -33	dBm dBm	VBATT = 3 to 4.8V, POUT = 5 to 33.2dBm
Stability: < 1GHz > 1GHz			-36 -30	dBm dBm	VSWR =10:1 All angles VBATT = 3 to 4.8V, POUT = 5 to 33.2dBm, TC = -20 to 85 °C
Ruggedness			10:1 VSWR		PIN = 4dBm, VBATT = 4.8V, POUT = 5 to 33.2dBm, All phases of load
RX Band Noise		-88	-84	dBm	FIN = 849MHz FOUT = 869 to 894MHz RBW = VBW = 100kHz, POUT = 5 to 33.2dBm
		-81	-78	dBm	FIN = 915MHz FOUT = 925 to 935MHz RBW = VBW = 100kHz, POUT = 5 to 33.2dBm
		-89	-86	dBm	FIN = 915MHz FOUT = 935 to 960MHz RBW = VBW = 100kHz, POUT = 5 to 33.2dBm
Input VSWR			2.5:1		All power levels

Table 7: DCS/PCS Electrical Specification

Test Conditions: Mode = DCS_PCS_TX_EN, VBATT = 3.5V, ZIN = ZOUT = 50Ω, TC = 25 ± 3°C, PIN = 2dBm,
PWIDTH = 1154μs, Duty Cycle = 25%

PARAMETER	MIN	TYP	MAX	UNITS	COMMENTS
Frequency (FIN)	1710 1850		1785 1910	MHz MHz	
Input Power (PIN)	0	2	4	dBm	
Output Power DCS/PCS (POUT)	30.5	31.5		dBm	VRAMP = 1.6V
Degraded Output Power	27.7	28.7		dBm	VBATT = 3.0V, VRAMP = 1.6V, PIN = 0dBm, TC = 85°C
Forward Isolation		-55	-51	dBm	PIN = 4dBm, VBATT = 3 to 4.8V Mode = DCS_RX_EN or PCS_RX_EN, see control table
Forward Isolation (2)		-25	-10	dBm	VRAMP = 0.2V, PIN = 4dBm, VBATT = 3 to 4.8V Mode = DCS_PCS_TX_EN, see control table
Harmonics 2fo to 12.75 GHz		-37	-33	dBm	VBATT = 3 to 4.8V, POUT = 0 to 30.4dBm
Stability: < 1GHz > 1GHz			-36 -30	dBm dBm	VSWR = 10:1 All angles VBATT = 3 to 4.8V, POUT = 0 to 30.4dBm, TC = -20 to 85 °C
Ruggedness:			10:1 VSWR		PIN = 2dBm, VBATT = 4.8V, POUT = 0 to 30.4dBm, All phases of load
RX Band Noise		-88	-84	dBm	FIN = 1785 or 1910MHz, FOUT = 1805 to 1880MHz, or 1930 to 1990MHz POUT = 0 to 30.4dBm, RBW = VBW = 100kHz
Input VSWR			2.5:1		All power levels

AWT6201

Table 8: Logic Control Table

MODE	CNTL 1	CNTL2	CNTL3	Description
SHUTDOWN	0	0	0	Low current state where module is disabled.
GSM900_RX_EN PCS_RX_EN	0	0	1	This mode enables a low loss path from the antenna to GSM900_RX port and from antenna to PCS_RX port. PA's are disabled and switch is in RX mode.
GSM850_RX_EN DCS_RX_EN	0	1	0	This mode enables a low loss paths from the antenna to GSM850_RX port, and from antenna to DCS_RX port. PA's are disabled and switch is in RX mode.
GSM_TX_EN	1	0	1	Switch is in transmit mode and GSM850/900PA is enabled.
DCS_PCS_TX_EN	1	1	0	Switch is in transmit mode and DCS/PCS PA is enabled.

Table 9: Control Timing

PARAMETER	MIN	TYP	MAX	UNITS	COMMENTS
Switching delay from RX to TX Mode		2		μs	
Switching delay from TX to RX Mode		2		μs	
P _{OUT} rise time		2		μs	Time for power at antenna to rise from -10dBm to maximum output power.
P _{OUT} fall time		2		μs	Time for power at antenna to fall from maximum output power to -10dBm.

Figure 2: Pinout (X-Ray View)

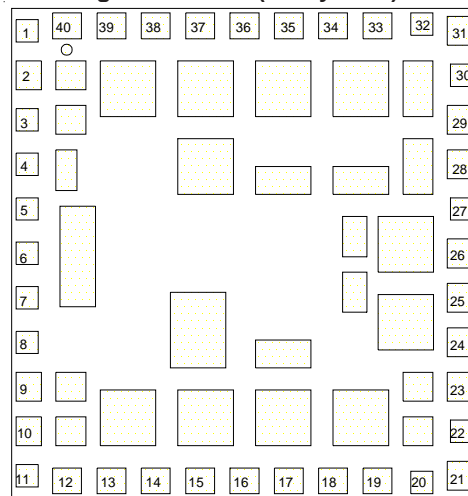

Note: unassigned pins
are ground pads

Table 10: Pinout Description

PIN	NAME	FUNCTION	PIN	NAME	FUNCTION
1	DCS/PCS_IN	DCS/PCS RF Input	21	GND	Ground
2	GND	Ground	22	GSM900_RX	GSM900 receive port
3	CNTL1	Control logic input	23	GND	Ground
4	CNTL2	Control logic input	24	GND	Ground
5	CNTL3	Control logic input	25	GND	Ground
6	VBATT	Battery supply connection	26	GND	Ground
7	VREG	Regulated supply connection	27	ANT	Antenna port
8	VRAMP	Analog input for power control	28	GND	Ground
9	GND	Ground	29	GND	Ground
10	GND	Ground	30	PCS_RX	PCS receive port
11	GSM_IN	GSM850/900 RF Input	31	GND	Ground
12	GND	Ground	32	DCS_RX	DCS receive port
13	GND	Ground	33	GND	Ground
14	GND	Ground	34	GND	Ground
15	GND	Ground	35	GND	Ground
16	GND	Ground	36	GND	Ground
17	GND	Ground	37	GND	Ground
18	GND	Ground	38	GND	Ground
19	GND	Ground	39	GND	Ground
20	GSM850_RX	GSM850 receive port	40	GND	Ground

AWT6201

PACKAGE OUTLINE DRAWING

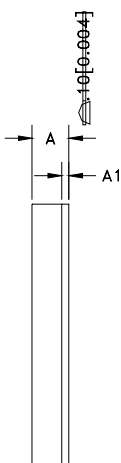
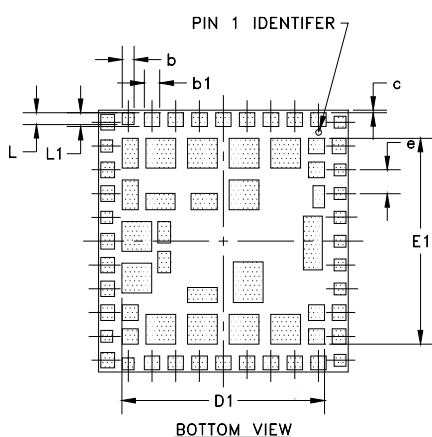
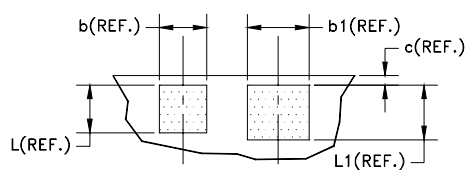

SIDE VIEW

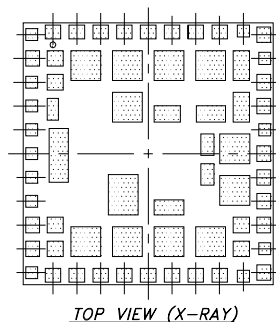

TOP VIEW (X-RAY)

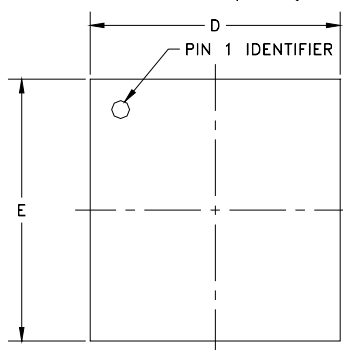

TOP VIEW

SYMBOL	MILLIMETERS			INCHES			NOTE
	MIN.	NOM.	MAX.	MIN.	NOM.	MAX.	
A	1.30	1.55	1.70	0.051	0.061	0.067	-
A1	-	0.31	-	-	0.012	-	-
b	-	0.50	-	-	0.019	-	13X
b1	-	0.65	-	-	0.025	-	27X
c	-	0.10	-	-	0.004	-	-
D	10.38	10.50	10.62	0.408	0.413	0.418	-
D1	-	8.50	-	-	0.335	-	3
E	10.88	11.00	11.12	0.428	0.433	0.438	-
E1	-	8.65	-	-	0.340	-	3
e	1.00 BSC			0.039 BSC			-
L	-	0.50	-	-	0.019	-	13X
L1	-	0.57	-	-	0.022	-	27X

NOTES:

1. CONTROLLING DIMENSIONS: MILLIMETERS
2. UNLESS SPECIFIED TOLERANCE = $\pm 0.05[0.002]$.
3. D1 AND E1 INDICATE OVERALL GROUND AREA. FOR PAD DETAIL AND LOCATION SEE PAGE 2.

PACKAGE OUTLINE DRAWING

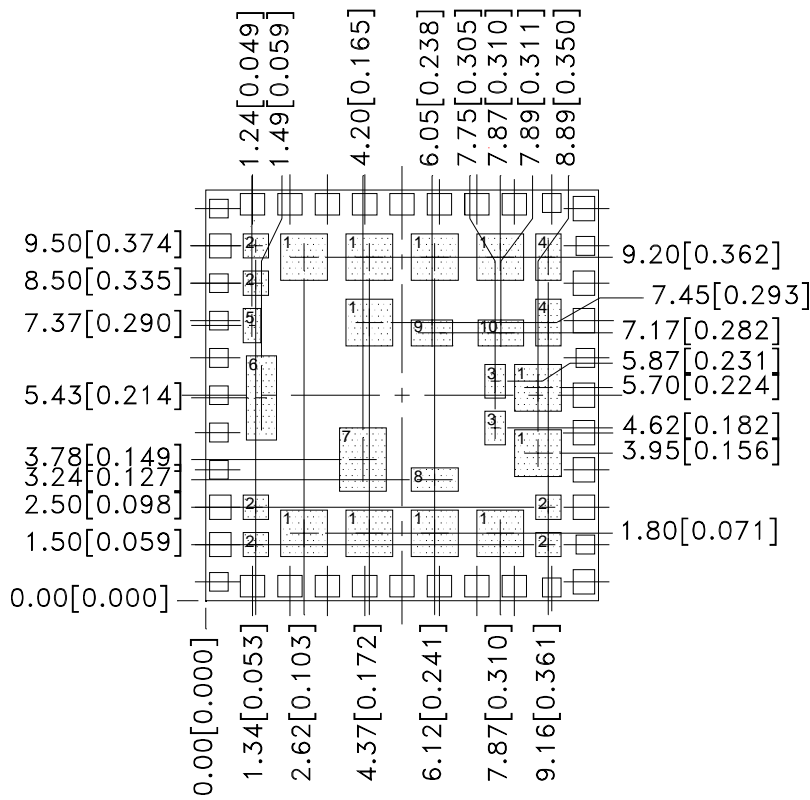

END PAD #	MILLIMETERS SIZE	INCHES SIZE	QTY.
1	1.25 X 1.25	0.049 X 0.049	11
2	0.67 X 0.65	0.026 X 0.025	6
3	0.55 X 0.90	0.021 X 0.035	2
4	0.67 X 1.25	0.026 X 0.049	2
5	0.47 X 0.92	0.018 X 0.036	1
6	0.80 X 2.25	0.031 X 0.088	1
7	1.25 X 1.70	0.049 X 0.066	1
8	1.25 X 0.62	0.049 X 0.024	1
9	1.10 X 0.69	0.043 X 0.027	1
10	1.22 X 0.69	0.048 X 0.027	1

TOP VIEW (X-RAY)

NOTES:

1. CONTROLLING DIMENSIONS: MILLIMETERS
2. UNLESS SPECIFIED TOLERANCE=±0.05[0.002].

AWT6201

NOTES

AWT6201

NOTES

AWT6201

ORDERING INFORMATION

ORDER NUMBER	TEMPERATURE RANGE	PACKAGE DESCRIPTION	COMPONENT PACKAGING
AWT6201			



ANADIGICS, Inc.

141 Mount Bethel Road
Warren, New Jersey 07059, U.S.A.
Tel: +1 (908) 668-5000
Fax: +1 (908) 668-5132

URL: <http://www.anadigics.com>
E-mail: Mktg@anadigics.com

IMPORTANT NOTICE

ANADIGICS, Inc. reserves the right to make changes to its products or to discontinue any product at any time without notice. The product specifications contained in Advanced Product Information sheets and Preliminary Data Sheets are subject to change prior to a product's formal introduction. Information in Data Sheets have been carefully checked and are assumed to be reliable; however, ANADIGICS assumes no responsibilities for inaccuracies. ANADIGICS strongly urges customers to verify that the information they are using is current before placing orders.

WARNING

ANADIGICS products are not intended for use in life support appliances, devices or systems. Use of an ANADIGICS product in any such application without written consent is prohibited.